

Mitsubishi Electric Research Laboratories (MERL)

Annual Report

July 2010 through March 2011

TR2011-00

(Published December 2011)

Welcome to Mitsubishi Electric Research Laboratories (MERL), the North American corporate R&D arm of Mitsubishi Electric Corporation. In this report, you will find descriptions of MERL and our projects.

This work may not be copied or reproduced in whole or in part for any commercial purpose. Permission to copy in whole or in part without payment of fee is granted for nonprofit educational and research purposes provided that all such whole or partial copies include the following: a notice that such copying is by permission of Mitsubishi Electric Research Laboratories; an acknowledgment of the authors and individual contributions to the work; and all applicable portions of the copyright notice. Copying, reproduction, or republishing for another purpose shall require a license with payment of fee to Mitsubishi Electric Research Laboratories. All rights reserved.

Copyright © Mitsubishi Electric Research Laboratories, 2011
201 Broadway, Cambridge, Massachusetts 02139
617.621.7500

Production:

Karen Dickie, Richard C. Waters

Table of Contents

Mitsubishi Electric Research Laboratories	1
Awards and Commendations	7
Technical Staff	9
Publications	23
Research	31
Digital Communications	33
Multimedia	41
Data Analytics	49
Imaging	55
Mechatronics	63
Algorithms	67

Mitsubishi Electric Research Laboratories

Mitsubishi Electric Research Laboratories (MERL) is the North American subsidiary of the corporate research and development organization of Mitsubishi Electric Corporation. MERL conducts application-motivated basic research and advanced development in communications, image/video processing, data analysis and mechatronics technology.

MERL's mission—our assignment from Mitsubishi Electric—is twofold.

- Generating new technology in areas of importance to Mitsubishi Electric.
- Significantly impacting Mitsubishi Electric's business: using our technical expertise in partnership with organizations in Mitsubishi Electric to produce new and improved products in Mitsubishi Electric's main areas of business.

MERL's vision—our goal for ourselves—is also twofold.

- To be one of the world's premiere research laboratories, significantly advancing the frontiers of technology and making lasting impacts on the world.
- To be the prime source of technology for Mitsubishi Electric in our areas of expertise.

MERL focuses on five principal technology sectors:

Digital Communications - featuring wired & wireless transmission technology & networking.

Multimedia – featuring speech interfaces and the encoding, decoding & analysis of video.

Data Analytics – featuring predictive and decision analytics.

Imaging – featuring computer vision algorithms and the observation of people in images.

Mechatronics – featuring advanced control of electro-mechanical systems.

An Algorithms group supports all five sectors, developing fundamental algorithms.

MERL is small enough to be agile and flexible in the dynamic marketplace of ideas. However, we gain leverage from the size, reputation, and diversity of our strong global parent. We turn our technical achievements into business successes by partnering with Mitsubishi Electric's business units and with other labs in Mitsubishi Electric's global R&D network.

We are strongly involved in the R&D community and standards activities, maintaining long-standing cooperative relationships with a number of research universities including MIT, CMU, USC, UC Berkeley, Georgia Tech, Harvard, Cornell, Univ of Wisconsin, Univ of Oklahoma, Boston Univ, Duke, and Univ of Toronto. We encourage our staff to be involved in their professional communities via conferences, papers, and continuing professional development.

MERL's output ranges from papers and patents, through proof-of-concept hardware and software prototypes, to modules for industry-first products.

This annual report is a snapshot of MERL's web site. For additional and updated information please visit "<http://www.merl.com>".

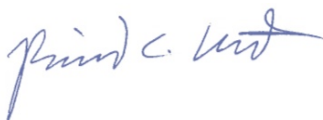

Richard C. Waters
President, MERL

MERL Organization

MERL is organized as six groups centered on technology areas, which collaborate closely to achieve groundbreaking results. We use a relatively flat organization to enhance the opportunities for collaboration within MERL. The five members of the top management team work closely together, guiding all aspects of MERL's operation.

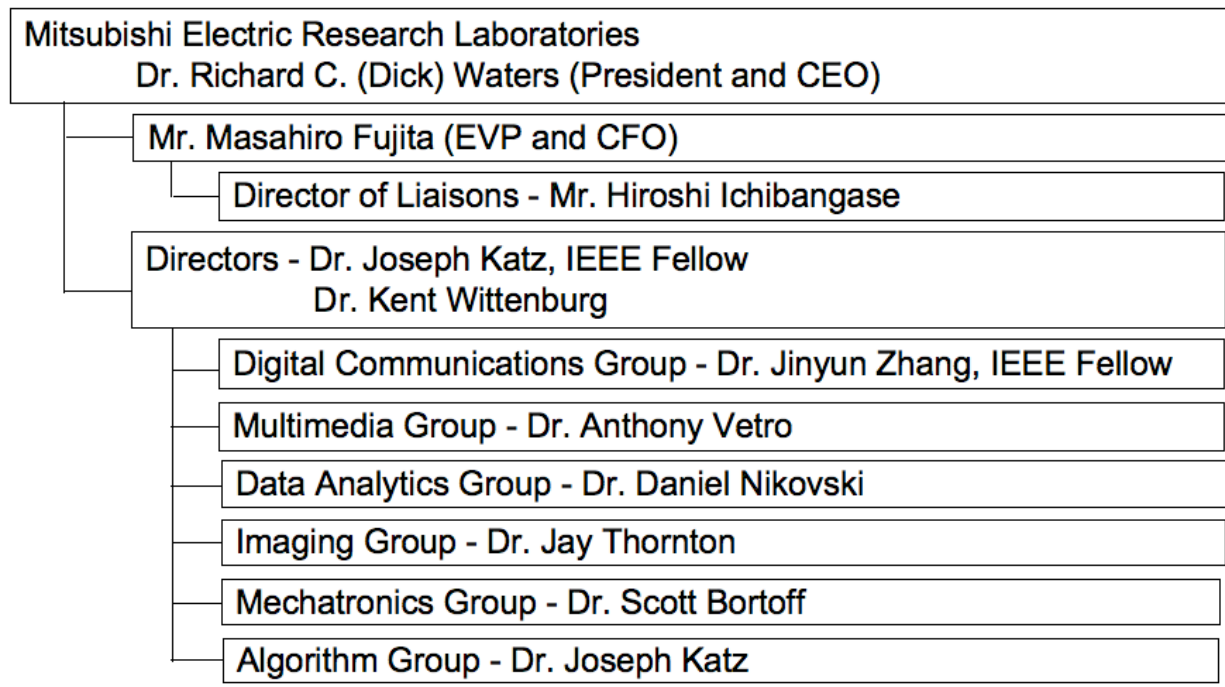

Richard C. (Dick) Waters *Ph.D., MIT, 1978*
President, Chief Executive Officer & Research Fellow

Dick Waters received his Ph.D. in artificial intelligence (AI). For the next 13 years he worked at the MIT AI Lab as a Research Scientist and co-principal investigator of the Programmer's Apprentice project. Dick was a founding member of MERL's Research Lab in 1991. As a MERL researcher, his work centered on multi-user interactive environments for work, learning, and play. For this work, he was made a MERL Research Fellow in 1996. In December 1999, he became CEO of MERL as a whole. In addition to his duties at MERL, Dick is currently a member of the board of directors of the Computing Research Association.



Masahiro Fujita *M.S., The University of Tokyo, 1983*
Executive Vice President, Chief Financial Officer & Chief Liaison Officer

Masahiro Fujita joined Mitsubishi Electric's Industrial Electronics & Systems Laboratory in 1983 where he developed motion control technologies for industrial robots and other equipment. He moved to the Factory Automation Business Unit's Nagoya works in 1999. He transferred to the Advanced Technology R&D Center in 2002 where he rose to Senior Manager of the Mechatronics Department, before coming to MERL in 2008.



Joseph Katz *Ph.D., California Institute of Technology, 1981*
Vice President & Director

After working at Caltech's Jet Propulsion Laboratory for a number of years, Joseph Katz went to Symbol Technologies, where as Senior VP of R&D he participated in, initiated, and led projects in a wide range of technologies, including barcode/RFID data capture, optics, imaging, signal processing, computing, networking, security, biometrics, and communications. He joined MERL's management in 2004.



Kent Wittenburg *Ph.D., University of Texas at Austin, 1986*
Vice President & Director

Kent Wittenburg performed research at the Microelectronics and Computer Technology Corporation (MCC), Bellcore, and Verizon/GTE laboratories. His research focused on Human-Computer Interaction (HCI) technologies and he managed groups in natural language interfaces and Internet technologies. He joined MERL in 2001 as the leader of speech and HCI research and was promoted to Director in 2002. He is a Senior member of the ACM.

Mitsubishi Electric

One of the world's largest companies, Mitsubishi Electric Corporation (Mitsubishi Electric) has \$44 billion in annual sales, \$2.8 billion in operating profits (in the economically challenging year ending in March 2011) and more than 114,000 employees around the world.

Mitsubishi Electric is composed of a wide range of operations. The primary business units are listed below.

Mitsubishi Electric Corp.
Information Systems & Network Services IT Systems, Information Security/Encryption Systems, Business Solutions
Public Utility Systems Government Systems, Transportation Systems, Very Large Display Devices
Energy & Industrial Systems Electrical Generators, Power Transmission and Distribution Equipment
Building Systems Elevators, Escalators, Building Monitoring/Security/Management Systems
Electronic Systems Satellites, Radar Systems, Antennas, Electronic Toll Collection Systems
Communication Systems Wired & Wireless Communication/Broadcasting Equipment and Systems
Living Environment & Digital Media Equipment Televisions, Blu-ray Recorders, Air Conditioners, Solar Power Systems
Factory Automation Systems Programmable Logic Controllers, Inverters, Servo-motors, Processing Machines
Automotive Equipment Automotive Electrical Equipment, Car Electronics/Multimedia, Car Mechatronics
Semiconductor & Device Optical Devices, High-Frequency & High-Power Semiconductors

Together, these ten business units produce most of Mitsubishi Electric's revenue. Due to the wide applicability of MERL's research, MERL works with them all.

It is worthy of note that there are over 30 major independent companies in the world that use the word "Mitsubishi" in their names. These companies include Mitsubishi UFJ Financial Group, Mitsubishi Corporation, Mitsubishi Heavy Industries, Mitsubishi Chemical Holdings and Mitsubishi Motors, all of which are also among the world's largest companies. They have shared roots in 19th century Japan; however, they have been separate for many years and Mitsubishi Electric has been separate from all of them since its founding in 1921.

Mitsubishi Electric’s US Operations

A significant part of Mitsubishi Electric’s sales are in North America and many of Mitsubishi Electric’s business units have North American subsidiaries. The largest US operations are listed below.

<p>Mitsubishi Electric Visual Solutions America, Inc. (Irvine CA) High Definition Projection Televisions, DVD Recorders</p>
<p>Mitsubishi Electric Automotive America, Inc. (Detroit, Mason OH) Alternators, Ignition Coils, Automotive Electronics</p>
<p>Mitsubishi Electric & Electronics USA, Inc. (Los Angeles & other cities) Air Conditioners, Elevators, Photovoltaic Panels, Semiconductors</p>
<p>Mitsubishi Electric Power Products, Inc. (Pittsburgh) Power Transmission Products</p>
<p>Mitsubishi Electric Automation, Inc. (Chicago) Factory Automation Equipment</p>

Mitsubishi Electric Corporate R&D

Mitsubishi Electric has a global R&D network comprising five laboratories. The chart below summarizes the primary activities of these labs. MERL collaborates with all of these labs.

Corporate R&D Headquarters (Tokyo)	
	<p>Advanced Technology R&D Center (Amagasaki & Nagaokakyo, in greater Osaka) Power Electronics, Electro-mechanical, Ecology, Energy, Materials, Devices, Systems and Imaging Technologies</p>
	<p>Information Technology R&D Center (Ofuna, in greater Tokyo) Information, Communications, Multimedia, Electro-Optic and Microwave Technologies</p>
	<p>Industrial Design Center (Ofuna, in greater Tokyo) Product, Interface and Concept Design</p>
	<p>Mitsubishi Electric Research Laboratories, Inc. (Boston) Communications, Multimedia, Data Analytics, Imaging and Mechatronics Technologies</p>
	<p>Mitsubishi Electric R&D Centre Europe, B.V. (Rennes, France & Livingston, UK) Communications, Energy & Environmental Technologies</p>

Awards and Commendations

The high caliber of MERL's research and researchers is evident in a variety of ways. Two are highlighted below. The first is the members of our staff that are Fellows of technical societies. The second is best paper awards received from outside organizations. Listed below are awards for the period of this Annual Report.

Current Technical Society Fellows

Dr. Joseph Katz, Fellow Institute of Electrical and Electronic Engineers
Dr. Joseph Katz, Fellow Optical Society of America
Dr. Huifang Sun, Fellow Institute of Electrical and Electronic Engineers
Dr. Anthony Vetro, Fellow Institute of Electrical and Electronic Engineers
Dr. Jin Zhang, Fellow Institute of Electrical and Electronic Engineers

Best Paper Awards

Guo, J.: Zhang, J., "Safety Message Transmission in Vehicular Communication Networks", *ITS World Congress (ITS)*, October 2010. (Outstanding paper award.)

Toshiaki Koike was granted a TELECOM Systems Technology Award for his recent papers by the Telecommunications Advancement Foundation of Japan in January 2011.

Technical Staff

The most important assets of MERL are its people. The following pages present the capabilities and interests of MERL's technical staff members as of the end of the period of this report. Additional information about their work can be found in the publications list and the project descriptions in this report. Complete information can be found in people's individual web pages at "<http://www.merl.com/people>".



Amit K. Agrawal *Ph.D., University of Maryland, 2006*
Member Research Staff

Prior to his graduate studies, Agrawal worked as a DSP engineer at Hughes Software Systems, India. His research interests are in computer vision, image processing and computational photography. Current research includes motion photography, flash photography, surface reconstruction from gradient fields, high dynamic range imaging, and image editing under variable illumination using gradient domain methods.



Ramesh Annavajjala *Ph.D., University of California at San Diego, 2006*
Member Research Staff

Annavajjala joined MERL in 2008. Prior to that, he was a Systems Research Engineer at ArrayComm LLC, in San Jose, CA., working for the development of advanced interference cancellation algorithms for next generation wireless standards. He received a best paper award from the IEEE WPMC 2009 conference.



Luigi (Lou) Baccari *B.S., University of Massachusetts of Lowell*
Manager Computational & Network Services

Baccari has 23 years of experience in the System and Network Administrations field. For the 6 years prior to joining MERL he worked at HP/Compaq's Cambridge Research Labs providing System and Network. Previous to that he worked for Force Computers, Lycos and Digital Equipment Corp. as Data Center Manger and in various System/Network Support roles.



John C. Barnwell III
Associate Member Research Staff

John Barnwell is a former Software Engineer developing configuration and database systems for the aircraft manufacturing, food processing, large truck manufacturing, and computer manufacturing industries. His current personal interests include amateur radio, CNC control systems, and mechanical and electrical design.



Mouhacine Benosman *Ph.D., Ecole Centrale de Nantes, 2002*
Principal Member Research Staff

Before coming to MERL in 2010, Benosman worked at universities in Rome Italy, Reims France and Glasgow Scotland before spending 4 years as a Research Scientist with the Temasek Laboratories at the National University of Singapore. His research interests include modeling and control of flexible systems, and nonlinear robust control and vibration suppression in industrial machines.



Ghulam M. Bhatti *Ph.D., Boston University, 1998*
Principal Member Research Staff

For his thesis, Bhatti specialized in distributed and parallel discrete event simulation. Before joining MERL in 2000, he worked as a Sr. Software Engineer at Evare LLC, Inc, developing software for a network switch and implementing an RSA cryptographic scheme. He also worked at Excel Tech. Ltd. (XLTEK) developing embedded software for a portable EEG device. Currently, he is working on Home Networking and Digital TV.



Scott A. Bortoff *Ph.D., University of Illinois Urbana Champaign, 1992*
Mechatronics Group Manager

After receiving his Ph.D., Scott became a professor in the Electrical and Computer Engineering department at the university of Toronto. More recently Scott worked at the United Technology Research Center, where he founded the Control Technology group and then managed that group as well as the Control Systems group.



Petros T. Boufounos *Sc.D., Massachusetts Institute of Technology, 2006*
Member Research Staff

Before joining MERL in 2009, he was with the Digital Signal Processing Group at Rice University doing research in the area of Compressive Sensing. In addition to compressive sensing, his immediate research interests include signal processing, data representations, frame theory, and machine learning applied to signal processing.



Matthew E. Brand *Ph.D., Northwestern University, 1994*
Distinguished Member Research Staff

Brand studies unsupervised learning from sensory data. His results include spectral solutions for reconstructing manifolds from samples, decision-theoretic elevator group control, a linear-time online SVD, recovery of non-rigid 3D shape from ordinary video, and an entropy optimization framework for learning. He has received best paper awards in computer vision (CVPR2001) and scheduling (ICAPS2003).



Dirk Brinkman *J.D., Suffolk University Law School, 1990*
Patent Counsel

Brinkman's undergraduate and Masters work was in Medical Physics. Prior to joining MERL in 1998, he spent most of his career at Digital Equipment Corporation, first as an engineer and product manager in the Medical Systems Group and then as a Patent Attorney for Digital's Research Laboratories in Cambridge MA and Palo Alto CA.



Daniel J. Burns *Ph.D., Massachusetts Institute of Technology, 2010*
Member Research Staff

At MIT, Burns developed mechanical designs and controllers for atomic force microscopes that image nano-scale features 1,000 times faster than commercially available instruments. Previously, Dan worked at the Commercial Aviation Systems division of Honeywell, and NASA's Goddard Space Flight Center. Currently, Dan works on control systems design and multi-physical modeling.



Robert A. Cohen *Ph.D., Rensselaer Polytechnic Institute, 2007*
Principal Member Research Staff

Prior to getting his Ph.D., Robert Cohen worked for 11 years at Philips Research Labs in NY on HDTV, scalable video streaming, video surveillance, and rapid prototyping for VLSI video systems. His current research interests are algorithms and architectures for video coding and communications, and video, image and signal processing. He is currently researching video transcoding and next-generation video coding algorithms.



Chunjie Duan *Ph.D., University of Colorado at Boulder, 2008*
Senior Principal Member Research Staff

Prior to joining MERL, he worked for Alcatel, Qualcomm and Ericsson and other telecom companies for over 10 years. His research interests are in wireless and optical communications, digital signal processing and VLSI/CAD technology. He is currently working on Ultra-Wideband system development and LSI implementation.



Huseyin Erdim *Ph.D., University of Connecticut Storrs, 2009*
Visiting Member Research Staff

During his master studies, Huseyin worked on improving productivity in free-form surface machining based on the physics of the cutting process, for which he received an Outstanding Young Researcher Award from the Japan Society of Mechanical Engineers in 2005. His research interests include theoretical and computational tools for systematic mechanical design, manufacturing and analysis.



Alan W. Esenther *M.Sc., Boston University, 1993*
Principal Member Research Staff

Esenther enjoys human-computer interaction (HCI) design, distributed software development, graphical user interfaces and Internet technologies. His recent work has focused on touch applications that support multiple concurrent users (think multiple mice), rapid image presentation for video browsing, and instant co-browsing (lightweight real-time distributed collaboration using unmodified web browsers).



Tyler W. Garaas *Ph.D., University of Massachusetts Boston, 2009*
Visiting Member Research Staff

Garaas was a member of the visual attention laboratory at U. Mass. Tyler earned his bachelor's degree in computer science at Montana State University. His work at UMass Boston included human visual attention studies, neural modeling of primate visual systems, and robotics.



Abraham M. Goldsmith *M.S., Worcester Polytechnic Institute, 2008*
Associate Member Research Staff

Abraham Goldsmith has five years industry experience as a design Electrical Engineer and holds a masters in Electrical Engineering from Worcester Polytechnic Institute. He's also very good at mechanical design and is a "shop demon".



Piyush Grover *Ph.D., Virginia Polytechnic Institute & State Univ., 2010*
Member Research Staff

Grover's research involves combining geometrical and statistical techniques to find and exploit structure in complex systems. He has worked in the areas of low-energy space mission design, fluid mixing and model reduction of distributed systems. His work has been published in Physical Review Letters and AIAA journals.



Jianlin Guo *Ph.D., Windsor University, 1995*
Principal Member Research Staff

Jianlin Guo received his Ph.D. from University of Windsor in 1995. He worked at Waterloo Maple as a software developer before joining MERL in 1998. His primary research interests include reliable wireless networks, SmartGrid systems, vehicular communications, broadband wireless communications, and embedded systems.



Bret A. Harsham *B.S., Massachusetts Institute of Technology*
Principal Member Research Staff

Harsham joined MERL in 2001 to pursue interests in speech interfaces and speech-centric devices. Previously, Bret spent 3 1/2 years at Dragon Systems designing and implementing handheld and automotive speech products. Earlier, he was a principal architect of a Firewall and Virtual Private Network product. Harsham's other technical interests include distributed architectures, knowledge representation, and language theory.



John R. Hershey *Ph.D., University of California San Diego, 2004*
Speech and Audio Team Leader

Before coming to MERL in 2010, Hershey was a researcher at IBM's Watson Research Center, where he was in the Speech Algorithms and Engines group, and team leader of the noise robustness project. At MERL, he works on research projects in the area of speech and audio signal separation, voice search, language processing, and user interfaces.



Mohamed E. Hussein *Ph.D., University of Maryland, College Park, 2009*
Adjunct Member Research Staff

Mohamed's Ph.D. research spanned visual object detection and parallel computing on graphics processing units. His research interests include computer vision, machine learning, and parallel computing.



Hiroshi Ichibangase *M.S., The University of Kyusyu, 1984*
Vice President and Director of Liaison

Ichibangase joined Mitsubishi Electric CR&D in 1984, developing optical communication equipment. He spent two years in the US in 2002-4 and then two years in the communications business unit. Returning to CR&D, he rose to Senior Manager of the Optical Communication Technology Department, before coming to MERL in 2010.



Frederick J. Igo, Jr. *B.A., LeMoyne College, 1982*
Senior Principal Member Research Staff

Igo's professional interests are in software development and its process. He joined MERL in 1985 and has worked on various software technologies, including Distributed Computing, Distributed OLTP, Message Queuing, Mobile Agents, OLAP/MDDDB and Data Mining. Prior to joining MERL Fred worked at IPL systems.



Yuri A. Ivanov *Ph.D., Massachusetts Institute of Technology, 2001*
Senior Principal Member Research Staff

Ivanov's main research interests lie in the area of Computer Vision, Machine Learning and Data Mining. In particular, he is interested in dynamic observations - video sequences, sounds, gestures, actions and events. He holds a visiting appointment with MIT department of Brain and Cognitive Sciences.



Elena J. Jakubiak *Ph.D., Tufts University, 2009*
Visiting Member Research Staff

Elena first joined MERL as an intern in 2003 and subsequently as a visiting scientist in 2009. During the intervening period, she pursued her PhD in computer graphics, researching problems pertaining to high-quality text rendering in collaboration with MERL. Currently, Elena continues research on text representations and rendering.



Michael J. Jones *Ph.D., Massachusetts Institute of Technology, 1997*
Senior Principal Member Research Staff

Jones joined MERL in 2001 after 4 years at the Digital/Compaq Cambridge Research Laboratory. His main area of interest is computer vision. He is particularly interested in using machine-learning approaches for solving computer vision problems. He has focused on algorithms for detecting and analyzing people in images and video such as face detection, skin detection and facial analysis using morphable models.



Toshiaki Koike-Akino *Ph.D., Kyoto University, 2005*
Adjunct Member Research Staff

Prior to joining MERL in 2010, Koike was a postdoctoral researcher at Harvard University. His research interests include cooperative communications, coding theory, information theory, body-area networks and device implementation. He received best paper awards at IEEE GLOBECOM'08 and GLOBECOM'09.



Keisuke Kojima *Ph.D., University of Tokyo, 1990*
Senior Principal Member Research Staff & Senior Liaison

Kojima spent 8 years in Mitsubishi Electric's Central Research lab and 9 years at AT&T Bell Labs. He has been involved in the research and development of semiconductor lasers, optical communication modules, and optical communication and sensor systems. He has authored/co-authored over 100 technical publications and conference presentations.



Christopher Laughman *Ph.D., Massachusetts Institute Technology, 2008*
Member Research Staff

Christopher received his Ph.D. in the Building Technology section of the department of Architecture at MIT. His current research includes the investigation of modeling and parameter identification problems for electrical, mechanical, and thermal systems as found in buildings and transportation systems.



Jonathan Leonard *B.S., Northeastern University, 2008*
Systems & Network Administrator

Jon works in the Central Services Department at MERL. He previously worked at MIT Lincoln Laboratory and graduated from Northeastern University. While not at work, he enjoys marital arts and regularly competes in competitions.



Dehong Liu *Ph.D., Tsinghua University, 2002*
Visiting Member Research Staff

Prior to joining MERL in 2010, Liu was a Senior Research Scientist at Duke University. His research interests include compressive sensing, signal processing, and machine learning.



Tim K. Marks *Ph.D., University of California San Diego, 2006*
Member Research Staff

Tim's research interests lie primarily in developing and applying statistical models for machine learning to problems in vision, both in order to solve problems in computer vision and in order to better understand human vision.



Barton E. Nicholls *Northeastern University*
System & Network Administrator

Nicholls is a member of MERL's Computer Network Services Group. He supports primarily UNIX and some Windows client and infrastructure software and hardware, and networking services for MERL. He comes to us from Verizon's Network Operations Management Group, and before that Information Technology at Art Technology Group.



Daniel N. Nikovski *Ph.D., Carnegie Mellon University, 2002*
Data Analytics Group Team Leader

Nikovski's research is focused on algorithms for reasoning, planning, and learning with probabilistic models. His current work is on the application of such algorithms to hard transportation problems such as group elevator control and traffic prediction. He also has varied interests in the field of data mining.



Philip V. Orlik *Ph.D., State University of New York at Stony Brook, 1999*
Mobile Systems Team Leader

Orlik joined MERL's digital communications and networking group in 2000. His research interests include wireless and optical communications, networking, queuing theory, and analytical modeling.



Kieran J. Parsons *Ph.D., University of Bristol, UK, 1996*
Senior Principal Member Research Staff

Prior to joining MERL in 2009, Parsons worked for Nortel, BelAir Networks an AMCC on wireless and optical networking technology. He is currently focused on optical communications architecture and system design.



Ronald N. Perry *B.Sc., Bucknell University, 1981*
Distinguished Member Research Staff

Prior to joining MERL in 1998, Perry was a consulting engineer at DEC developing a three-dimensional rendering ASIC called Neon. Ron has consulted for many companies including Kodak, Adobe, Quark, and Apple over the last 20 years, developing software and hardware products in the areas of computer graphics, imaging, color, and desktop publishing. Ron's research interests are centered on key algorithms in computer graphics.



Fatih M. Porikli *Ph.D., Polytechnic University, 2002*
Senior Principal Member Research Staff

Porikli's research interests are in the areas of video processing, computer vision, aerial image processing, 3-D depth estimation, texture segmentation, robust optimization, network traffic management, multi-camera systems, data mining, and digital signal filtering. Before joining MERL in 2000, he worked for Hughes Research Labs, Malibu, CA (1999) and AT&T Research Labs, Holmdel, NJ (1997).



Srikumar Ramalingam *Ph.D., INRIA Alpes, 2007*
Member Research Staff

During his Ph.D. Srikumar worked on multi-view geometry algorithms for omni-directional and non-central camera models. His doctoral thesis received the best thesis prize and an honorable mention for the annual AFRIF thesis prize from the French Association for Pattern Recognition.



Shantanu Rane *Ph.D., Stanford University, 2007*
Principal Member Research Staff

Shantanu Rane's Ph.D. thesis applied distributed source coding concepts to error-resilient video transmission. Shantanu's research interests are in the areas of image communication and information theory. At MERL, he is working on problems involving distributed compression of images and video.



Zafer Sahinoglu *Ph.D., New Jersey Institute of Technology, 2001*
Senior Principal Member Research Staff

Sahinoglu worked at AT&T Shannon Labs in 1999, and joined MERL in March 2001. His research interests include home networking, QoS in video streaming and multicasting, wireless image sensor networks, traffic self-similarity and biomedical signal processing. He has made significant contributions to the emerging MPEG-21 and ZigBee standards.



Bent K. Schmidt-Nielsen *B.S. Univ. of California at San Diego, 1971*
Senior Principal Member Research Staff

Schmidt-Nielsen spent 7 years at Dragon Systems applying speech recognition to useful products. At MERL he is paying a lot of attention to making speech interfaces robust and usable. He has very broad interests in science and technology. Among many other activities he has taught genetics at the University of Massachusetts at Boston and he has been a leader in the development of an easy to use mass-market database.



Vijay Shilpiekandula *Ph.D., Massachusetts Institute of Technology, 2010*
Member Research Staff

Vijay received the 2008 R.V. Jones Memorial Scholarship from the American Society for Precision Engineering (ASPE) for his doctoral research on the design and control of flexure-based nano-positioning systems. His research interests include system dynamics, constrained linear and non-linear control, system identification, estimation and learning.



Alan Sullivan *Ph.D., University of California at Berkeley, 1993*
Senior Principal Member Research Staff

Prior to joining MERL, Alan Sullivan worked on developing and commercializing the DepthCube volumetric 3D display technology. He has 8 issued patents and 15 patents pending in the fields of display technology, computer graphics, material science and optics.



Hongbo Sun *Ph.D., Chongqing University, 1991*
Principal Member Research Staff

Prior to joining MERL in 2010, Sun was a principal applications Engineer at Oracle, and a technical architect at SPL WorldGroup. He is a registered professional engineer and has more than 20 years' experience in technical consulting, product development and research on electrical transmission and distribution system planning, analysis, operation, and automation.



Huifang Sun *Ph.D., University of Ottawa, 1986*
MERL Fellow / IEEE Fellow

After four years as a Professor at Fairleigh Dickinson University, Huifang Sun moved to the Sarnoff Research Laboratory in 1990 becoming Technology Leader for Digital Video Communication. In 1995, Huifang joined MERL as the leader of our video efforts. In recognition of his productive career in video processing Huifang was made an IEEE Fellow in 2001. He was made a MERL Research Fellow in 2003.



Wei Sun *Ph.D., University of Waterloo, 2006*
Visiting Member Research Staff

Prior to joining MERL in 2008, Wei Sun worked as a research fellow at the University of Waterloo for two years. His main research interests include multimedia security, biometrics, information security and privacy, compressive sensing and information theory. He also has a Ph.D. in cryptography and a Master degree in mathematics.

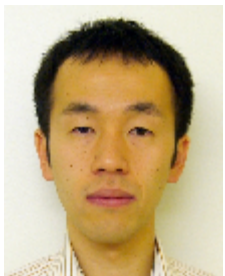

Yuichi Taguchi *Ph.D. The University of Tokyo, 2009*
Adjunct Member Research Staff

Yuichi Taguchi received his B.E., M.E., and Ph.D. degrees in information and communication engineering from the University of Tokyo, Japan, in 2004, 2006, and 2009, respectively. He initially joined MERL as a postdoc in April 2009. His research interests are in computer vision, image-based rendering, and computational photography.



Koon Hoo Teo *Ph.D., University of Alberta 1990*
Ubiquitous Networks Team Leader

Teo was with Nortel for about 15 years where he was actively involved in the research and implementation issues of a number of 3G and 4G wireless systems including Wireless Mesh Networks and WiMAX systems. His current research interests include Cognitive Radio, location tracking using Ultra Wideband technology, and Wireless Mesh and Multi-Hop Systems.



Jay E. Thornton *Ph.D., University of Michigan, 1982*
Imaging Group Manager

Thornton worked at Polaroid Corporation for many years, first in the Vision Research Laboratory and then as manager of the Image Science Laboratory. There, he worked on problems in color reproduction, image quality and image processing. He joined MERL in 2002 as Manager of the Computer Human Observation project, focusing on the computer vision problems that arise when computers analyze, count, detect, and recognize people.



Dong Tian *Ph.D., Beijing University of Technology, 2001*
Principal Member Research Staff

In 2002, Dr. Tian started making contributions to the H.264 /MPEG-4 AVC standard and later to the MVC extension. Since joining MERL in the summer of 2010, he has continued his research on 3D video coding and processing.



Kinh Tieu *Ph.D., Massachusetts Institute of Technology, 2006*
Visiting Member Research Staff

Kinh got his PhD from MIT in 2006 and since then has been a Research Fellow (in Radiology) at Brigham and Women's Hospital. At MERL, Kinh is working on medical image processing. He has also had a lot of experience in the application of statistical models to computer vision problems like multi-camera tracking.



Katsuhiko Tsujino *Ph.D., Osaka University, 1989*
Japanese Liaison / Assistant Manager

Tsujino joined Mitsubishi Electric Corp. in 1989 designing and implementing software systems based on his expertise in Artificial Intelligence, Knowledge Engineering, Knowledge Acquisition and Machine Learning. Following two years in the Strategic Planning Department of the Advanced Technology R&D Center, he joined MERL in August 2008.



C. Oncel Tuzel *Ph.D., Rutgers University, 2008*
Member Research Staff

Oncel's doctoral work focused on statistical learning techniques on smooth manifolds and their applications to scene analysis. He received the best paper runner-up award at CVPR 2007. His research interests are in computer vision, machine learning, pattern recognition, and computer graphics.



Ashok Veeraraghavan *Ph.D., Univ. of Maryland, College Park, 2008*
Member Research Staff

Ashok's research interests are in signal, image and video processing, computer vision, pattern recognition and computational photography. His thesis received the Doctoral Dissertation award from the Department of Electrical and Computer Engineering at the University of Maryland.



Anthony Vetro *Ph.D., Polytechnic University, 2001*
Multimedia Group Manager

Vetro joined MERL in 1996. His research interests are related to the encoding and transport of multimedia content. He has been an active participant in MPEG standards for several years. Dr. Vetro has contributed several technologies to MELCO products, including MPEG-2/4 transcoding for surveillance, post-filtering for artifact reduction and video down-decoding for a low-cost DTV receiver chip.



Gene V. Vinokur *M.S., Boston University, 2003*
Patent Agent

Prior to joining MERL, Vinokur spent four years at Putnam Investments developing software applications for the financial industry. He has been a licensed Patent Agent since 2003. He joined MERL's Patent Department in 2006.

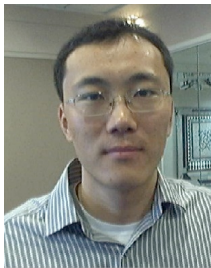

Bingnan Wang *Ph.D., Iowa State University 2009*
Adjunct Member Research Staff

Bingnan Wang's graduate work focused on the study of wave propagation phenomena, such as surface waves and negative refraction, in novel electromagnetic materials, including photonic crystals and metamaterials.



Yebin Wang *Ph.D., University of Alberta, 2008*
Member Research Staff

Prior to joining MERL, Yebin was a research assistant of Applied Nonlinear Control Laboratory of the Department of Electrical & Computer Engineering at the University of Alberta. Yebin's research interests include nonlinear observer/control design and applications, optimization, adaptive system, and mechatronics.



Jingyang Xu *Ph.D., University of Buffalo, 2010*
Adjunct Member Research Staff

Xu worked on optimization algorithms for complex scheduling problems when he was a member of the Operations Research Lab at the University of Buffalo. His main research interest is identifying new application areas of stochastic discrete optimization. His current research includes modeling and optimization for thermal, transportation, and power systems.



Jonathan S. Yedidia *Ph.D., Princeton University, 1990*
Distinguished Member Research Staff

Yedidia's graduate work focused on theoretical condensed-matter physics, particularly the statistical mechanics of systems with quenched disorder. In 1997, he changed his focus to computer software and worked for a company called Viaweb on what has since become Yahoo's shopping service. At MERL since 1998, his particular interest is in the development of new methods of belief propagation in constraint networks.



William S. Yerazunis *Ph.D., Rensselaer Polytechnic Institute, 1987*
Senior Principal Member Research Staff & Hardware Team Leader

Yerazunis has worked in a number of fields including: optics, vision processing, and signal processing, computer graphics, artificial intelligence parallel symbolic computation, radio astronomy and SETI, transplant immunology, virtual and augmented reality (Diamond Park and SPLINE), real-time sensing and ubiquitous computing, and real-time statistical categorization of text (for spam filtering).



Jinyun Zhang *Ph.D., University of Ottawa, 1991*
MERL Fellow , IEEE Fellow
Digital Communication Group Manager

Jinyun manages MERL's digital communications group. Before joining MERL in 2001, She worked for Nortel Networks for 10 years where she held engineering and management positions in the areas of VLSI design and advanced wireless & optical technology development. In recognition for her contributions to broadband wireless transmission and networking technology she became an IEEE Fellow in 2008.



Weihong Zhang *Ph.D., Hong Kong Univ. of Science & Technology, 2001*
Visiting Member Research Staff

Weihong Zhang is working on problems involving scheduling, planning, and sequential decision making under uncertainty. His interests and experience are related to developing probabilistic algorithms and applying them to real-world domains.

Recent Major Publications

The following lists the major publications by members of the MERL staff. (There are fewer publications than in a typical annual report because this report only covers 9 months instead of 12.) A publication is considered major if it appeared in a refereed journal, a refereed conference proceedings or some other significant publication such as a book.

An asterisk (*) appears before a publication that was subject to highly stringent selection criteria where it was published. Some venues (such as major journals and certain key conferences) are very selective in what they publish and some (such as workshops and many conferences) are not. There are good reasons to publish something in a non-selective venue, the most important of which is that a given workshop or conference may be the best place to expose a particular piece of work to the scientific community. However, the appearance of a piece of work in a non-selective venue does not by itself say much about the quality of the work. In contrast, getting a piece of work into a highly selective venue is a mark of distinction that says a lot about the quality of the work in the eyes of the scientific community.

As a basis for assessing the selectivity of various venues, the list below uses acceptance rates. For instance, certain key conferences such as CHI, ICCV, and CVPR accept only 20% or less of the papers submitted to them, rejecting many papers that in fact describe fine work. In contrast, many workshops and regional conferences accept 80% or more of the papers submitted, taking everything but the truly awful. The list puts an asterisk before a conference or workshop paper only if the acceptance rate was less than 30%, or the paper received a best paper award. In addition, asterisks appear before papers in major archival Journals.

2011

Sezer, O.G.; Cohen, R.A.; Vetro, A., "Robust Learning of 2-D Separable Transforms for Next-Generation Video Coding", *Data Compression Conference*, March 2011 ([TR2011-021](#))

- * Oh, K.-J.; Vetro, A.; Ho, Y-S., "Depth Coding Using a Boundary Reconstruction Filter for 3-D Video Systems", *IEEE Transactions on Circuits and Systems for Video Technology*, ISSN: 1051-8215, Vol. 21, Issue 3, pp. 350, March 2011 ([TR2011-003](#))

- * Koike-Akino, T.; Molisch, A.F.; Duan, C.; Tao, Z.; Orlik, P., "Capacity, MSE and Secrecy Analysis of Linear Block Precoding for Distributed Antenna Systems in Multi-User Frequency-Selective Fading Channels", *IEEE Transactions on Communications*, ISSN: 0090-6773, Vol. 59, Issue 3, pp. 888, March 2011 ([TR2011-014](#))

Ruta, A.; Porikli, F.M.; Watanabe, S.; Li, Y., "In-vehicle Camera Traffic Sign Detection and Recognition", *Machine Vision and Applications*, Vol. 22, Issue 2, March 2011 ([TR2011-041](#))

Wang, P.; Sahinoglu, Z.; Pun, M-O; Li, H.; Himed, B., "Knowledge-Aided Adaptive Coherence Estimator in Stochastic Partially Homogeneous Environments", *IEEE Signal Processing Letters*, ISSN: 1070-9908, Vol:18, Issue 3, pp. 193-196, March 2011 ([TR2011-010](#))

Laska, J.N.; Boufounos, P.T.; Davenport, M.A., Baraniuk, R.G., "Democracy in Action: Quantization, Saturation and Compressive Sensing", *Applied and Computational Harmonic Analysis*, February 2011 ([TR2011-049](#))

- * Chen, R-R.; Teo, K.H.; Farhang-Boroujeny, B., "Random Access Protocols for Collaborative Spectrum Sensing in Multi-Band Cognitive Radio Networks", *IEEE Journal of Selected Topics in Signal Processing*, ISSN: 1932-4553, Vol. 5, Issue 1, pp.124-136, February 2011 ([TR-2011-044](#))
- * Yedidia, J.S.; Wang, Y.; Draper, S.C., "Divide and Concur and Difference - Map BP Decoders for LDPC Codes", *IEEE Transactions on Information Theory*, ISSN 0018-9448, Vol. 57, Issue 2, pp. 786-802, February 2011 ([TR2010-001](#))

Sahinoglu, Z., "Improving Range Accuracy of IEEE.802.15.4a Radios in the Presence of Clock Frequency Offsets", *IEEE Communications Letters*, ISSN 1089-7798, Vol. 15, Issue 2, pp. 244-246, February 2011 ([TR2011-019](#))

Annavajjala, R.; Orlik, P.V., "Achieving Near-Exponential Diversity on Uncoded Low-Dimensional MIMO, Multi-User and Multi-Carrier Systems without Transmitter CSI", *IEEE Information Theory and Applications Workshop (ITA)*, ISBN 978-1-4577-0360, pp. 1-11, February 2011 ([TR2011-011](#))

Wang, Y.; Rane, S.; Draper, S.C.; Ishwar, P., "An Information-Theoretic Analysis of Revocability and Reusability in Secure Biometrics", *Information Theory and Applications Workshop (ITA)*, February 2011 ([TR2011-005](#))

Mueller, C.; Weinberg, G., "Multimodal Input in the Car, Today and Tomorrow", *IEEE Multimedia*, ISSN 1070-986X, Vol. 18, No. 1, pp. 98-103, January 2011 ([TR2011-002](#))

Sturm, P.; Ramalingam, S.; Tardif, J-P; Gasparini, S.; Barreto, J., "Camera Models and Fundamental Concepts Used in Geometric Computer Vision", *Foundations and Trends in Computer Graphics and Vision*, Vol. 6, Issue 1-2, January 2011 ([TR2011-003](#))

- * Ramachandran, M.; Veeraraghavan, A.; Chellappa, R., "A Fast Bilinear Structure from Motion Algorithm Using a Video Sequence and Inertial Sensors", *IEEE Transactions on Pattern Analysis and Machine Intelligence*, ISSN: 0162-8828, Vol. 33, Issue 1, pp. 186-193, January 2011 ([TR2011-042](#))
- * Pun, M-O; Koivunen, V.; Poor, H.V., "Performance Analysis of Joint Opportunistic Scheduling and Receiver Design for MIMO-SDMA Downlink Systems", *IEEE Transactions on Communications*, ISSN 0090-6778, Vol. 59, Issue 1, pp. 268-280, January 2011 ([TR2011-006](#))

Maaref, A.; Annavajjala, R.; Zhang, J., "Comparison of Analog and Digital Network Coding Approaches for Bidirectional Relaying with Private Messages to the Relay", *IEEE Consumer Communications & Networking Conference (CCNC)*, ISBN: 978-1-4244-8789-9, pp. 1207-1211, January 2011 ([TR2011-008](#))

- * Ye, F.; Yim, R.; Roy, S.; Zhang, Z., "Efficiency and Reliability of One-Hop Broadcasting in Vehicular Ad Hoc Networks", *IEEE Journal on Selected Areas in Communications*, ISSN: 0733-8716, Vol. 29, Issue 1, pp.: 151-160, January 2011 ([TR2011-013](#))

2010

- * Taguchi, Y.; Agrawal, A.K.; Veeraraghavan, A.; Ramalingam, S.; Raskar, R., "Axial-Cones: Modeling Spherical Catadioptric Cameras for Wide-Angle Light Field Rendering: ", *ACM Transactions on Graphics (TOG)*, ISBN: 978-1-4503-0439-9, Vol. 29, Issue 6, December 2010 ([TR2010-107](#))
- Rane, S.; Sun, W., "Privacy Preserving String Comparisons Based on Levenshtein Distance", *IEEE International Workshop on Information Forensics and Security (WIFS)*, ISBN 978-1-4144-9078-3, pp. 1-6, December 2010 ([TR2010-109](#))
- Pathak, M.; Rane, S.; Raj, B., "Multiparty Differential Privacy via Aggregation of Locally Trained Classifiers", *Neural Information Processing Systems (NIPS)*, December 2010 ([TR2010-042](#))
- Rane, S.; Wang, Y.; Boufounos, P.T.; Vetro, A., "Wyner-Ziv Coding of Multispectral Images for Space and Airborne Platforms", *Picture Coding Symposium (PCS)*, ISBN 978-1-4244-7134-8, pp. 234-237, December 2010 ([TR2011-045](#))
- * Pun, M-O.; Sahinoglu, Z.; Shah, S.; Hara, Y.; Wang, P., "Two-Step Low-Complexity Space-Time Adaptive Processing (STAP)", *IEEE Global Telecommunications Conference (GLOBECOM)*, ISSN 1930-529X, pp. 1-5, December 2010 ([TR2010-119](#))
- * Takenaka, T.; Sahinoglu, Z.; Bhatti, G.M.; Zhang, J.; Mineno, H.; Mizuno, T., "Multi-hop Localization Using Mobility (MLM) in Mixed LOS/NLOS Environments", *IEEE Global Telecommunications Conference (GLOBECOM)*, ISSN: 1930-529X, pp. 1-6, December 2010 ([TR2010-043](#))
- * Koike-Akino, T.; Orlik, P.V., "High-Order Super-Block GLRT for Non-Coherent Grassmann Codes in MIMO-OFDM Systems", *IEEE Global Telecommunications Conference (GLOBECOM)*, ISSN 1930-529X, pp. 1-6, December 2010 ([TR2010-120](#))
- Maaref, A.; Annavajjala, R., "The Gamma Variate with Random Shape Parameter and Some Applications", *IEEE Communications Letters*, ISSN 1089-7798, Vol. 14, Issue 12, pp. 11146-1148, December 2010 ([TR2011-007](#))
- Oh, K-J.; Yea, S.; Vetro, A.; Ho, Y-S., "Virtual View Synthesis Method and Self-Evaluation Metrics for Free Viewpoint Television and 3D Video", *International Journal of Imaging Systems and Technology*, Vol. 20, Issue 4, December 2010 ([TR2010-116](#))
- * Annavajjala, R.; Chockalingam, A.; Mohammed, S.K., "On a Ratio of Functions of Exponential Random Variables and Some Applications", *IEEE Transactions on Communications*, ISSN 0090-6778, Vol. 58, Issue 11, pp. 3091-3097, November 2010 ([TR2010-118](#))

- Zhang, J., "The Latest Development of SmartGrid", *SmartGrids China*, November 2010 ([TR2010-093](#))
- Annavajjala, R.; Zhang, J., "Level Crossing Rates and Average Outage Durations of SINR with Multiple Co-Channel Interferers", *Military Communications Conference (MILCOM)*, issn 2155-7578, pp. 1233-1238, October 2010 ([TR2010-115](#))
- Boufounos, P.T.; Asif, M.S., "Compressive Sensing for Streaming Signals using the Streaming Greedy Pursuit", *Military Communications Conference (MILCOM)*, ISSN 2155-7578, pp. 1205-1210, October 2010 ([TR2010-102](#))
- * Luo, G.; Garaas, T.W.; Pomplun, M.; Peli, E., "Inconsistency between Peri-saccadic Mislocation and Compression: Evidence for Separate "What" and "Where" Visual Systems", *Journal of Vision (J Vis)*, pp.549-586, October 2010 ([TR2010-105](#))
- Yim, R.; Saito, M.; Zhang, J., "Digital Lane Marking for Geo-Information Dissemination", *ITS World Congress (ITS)*, October 2010 ([TR2010-113](#))
- Yim, R.; Ye, F.; Roy, S.; Orlik, P.V., "Effect of Transmission Parameters on Efficiency and Reliability of V2V Networks", *ITS World Congress (ITS)*, October 2010 ([TR2010-111](#))
- Guo, J.; Tsuboi, T.; Zhang, J., "Location Aware Fast Handover Between WiMax and WiFi Networks", *ITS World Congress (ITS)*, October 2010 ([TR2010-112](#))
- Guo, J.; Zhang, J., "Safety Message Transmission in Vehicular Communication Networks", *ITS World Congress (ITS)*, October 2010 ([TR2010-101](#))
- Boz, Y.; Erdim, H.; Lazoglu, I., "Prediction of Cutting Forces for 5-Axis Ball-End Milling of Free-Form Surfaces", *International Conference on High Performance Cutting (CIRP)*, October 2010 ([TR2010-114](#))
- Ramalingam, S.; Bouaziz, S.; Sturm, P.; Brand, M.E., "SKYLINE2GPS: Localization in Urban Canyons Using Omni-skylines", *IEEE/RSJ International Conference on Intelligent Robots and Systems (IROS)*, ISSN 2153-0858, pp. 3816-3823, October 2010 ([TR2010-097](#))
- * Thejaswi, P.S.C.; Zhang, J.; Pun, M-O; Poor, H.V.; Zheng, D., "Distributed Opportunistic Scheduling with Two-Level Probing", *IEEE/ACM Transactions on Networking*, ISSN: 1063-6692, Vol. 18, Issue 5, pp. 1464-1477, October 2010 ([TR2010-096](#))
- Momcilovic, S.; Wang, Y.; Rane, S.; Vetro, A., "Toward Realtime Side Information Decoding on Multi-core Processors", *IEEE International Workshop on Multimedia Signal Processing (MMSP)*, ISBN 978-1-4244-8110-1, pp. 321-326, October 2010 ([TR2010-100](#))

Wang, Y.; Rane, S.; Sun, W.; Ishwar, P., "On Unconditionally Secure Computation with Vanishing Communication Cost", *Allerton Conference on Communication, Control and Computing*, DOI: 10.1109/ALLERTON.2010.5707010, September 2010 ([TR2010-092](#))

Nikovski, D.N.; Zhang, W., "Factored Markov Decision Process Models for Stochastic Unit Commitment", *IEEE Conference on Innovative Technologies for an Efficient and Reliable Electricity Supply (CITRES)*, ISBN 978-1-4244-6076-2, pp. 28-35, September 2010 ([TR2010-083](#))

Cohen, R.A.; Klomp, S.; Vetro, A.; Sun, H., "Direction-Adaptive Transforms for Coding Prediction Residuals", *IEEE International Conference on Image Processing (ICIP)*, ISSN 1522-4880, pp. 185-188, September 2010 ([TR2010-090](#))

Vetro, A., "Frame Compatible Formats for 3D Video Distribution", *IEEE International Conference on Image Processing (ICIP)*, ISSN 1522-4880, pp. 2405-2408, September 2010 ([TR2010-099](#))

Asif, M.S.; Reddy, D.; Boufounos, P.T.; Veeraraghavan, A., "Streaming Compressive Sensing for High-Speed Periodic Videos", *IEEE International Conference on Image Processing (ICIP)*, ISSN 1522-4880, pp. 3373-3376, September 2010 ([TR2010-091](#))

Min, D.; Yea, S.; Vetro, A., "Occlusion Handling Based on Support and Decision", *IEEE International Conference on Image Processing (ICIP)*, ISSN 1522-4880, pp.1777-1780, September 2010 ([TR2010-098](#))

Gouvea, E.; Ezzat, T., "Vocabulary Independent Spoken Query: a Case for Subword Units", *Interspeech*, September 2010 ([TR2010-089](#))

Guvenc, I.; Gezici, S.; Sahinoglu, Z., "Fundamental Limits and Improved Algorithms for Linea Least-Squares Wireless Position Estimation", *Wireless Communications and Mobile Computing*, DOI: 10.1002/wcm.1029, September 2010 ([TR2010-108](#))

Sahinoglu, Z.; Tao, Z.; Teo, K-H., "Off-Grid Portable EV Charging Network Management with Dynamic Energy Pricing", *International IEEE Conference on Intelligent Transportation Systems (ITSC)*, ISSN 2153-0009, pp. 403-408, September 2010 ([TR2010-088](#))

- * Kim, K. J; Pun, M-O; Iltis, R.A., "Joint Carrier Frequency Offset and Channel Estimation for Uplink MIMO-OFDMA Schmidt Rao-Blackwellized Particle Filters", *IEEE Transactions on Communications*, ISSN: 0090-6778, Vol. 58, Issue 9, pp. 2697-2708, September 2010 ([TR2010-095](#))

Weinberg, G.; Harsham, B.; Forlines, C.; Medenica, Z., "Contextual Push-to-talk: Shortening Voice Dialogs to Improve Driving Performance", *International Conference on Human Computer Interaction with Mobile Devices and Services (MOBILEHCI)*, ISBN: 978-1-60558-835-3, pp. 113-122, September 2010 ([TR2010-085](#))

- Weinberg, G.; Harsham, B.A., "Object-Oriented Multimodality for Safer-In-Vehicle Interfaces", *Speech in Mobile and Pervasive Environments (SiMPE)*, September 2010 ([TR2010-094](#))
- Li, Z.; Sahinoglu, Z.; Tao, Z.; Teo, K.H., "Electric Vehicles Network with Nomadic Portable Charging Stations", *IEEE Vehicular Technology Conference (VTC)*, ISSN: 1090-3038, pp. 1-5, September 2010 ([TR2010-104](#))
- * Gupta, M.; Agrawal, A.K.; Veeraraghavan, A.; Narasimhan, S.G., "Flexible Voxels for Motion-Aware Videography", *European Conference on Computer Vision (ECCV)*, ISBN: 3-642-15548-0 978-3-642-15548-2, September 2010 ([TR2010-103](#))
 - * Sankaranarayanan, A.C.; Veeraraghavan, A.; Tuzel, C.O.; Agrawal, A.K., "Image Invariants for Smooth Reflective Surfaces", *European Conference on Computer Vision (ECCV)*, September 2010 ([TR2010-082](#))
 - * Ramalingam, S.; Taguchi, Y.; Marks, T.K.; Tuzel, C.O., "P2Pi: A Minimal Solution for Registration of 3D Points to 3D Planes", *European Conference on Computer Vision (ECCV)*, ISBN: 3-642-15554-5 978-3-642-15554-3, September 2010 ([TR2010-086](#))
 - * Chaudhry, R.; Ivanov, Y.A., "Fast Approximate Nearest Neighbor Methods for Non-Euclidean Manifolds with Applications to Human Activity Analysis in Videos", *European Conference on Computer Vision (ECCV)*, September 2010 ([TR2010-087](#))
 - * Agrawal, A.K.; Taguchi, Y.; Ramalingam, S., "Analytical Forward Projection for Axial Non-Central Dioptric & Catadioptric Cameras", *European Conference on Computer Vision (ECCV)*, September 2010 ([TR2010-081](#))
- Wang, B.; Nishino, T.; Teo, K.H., "Wireless Power Transmission Efficiency Enhancement with Metamaterials", *IEEE International Conference on Wireless Information Technology and Systems (ICWITS)*, ISBN 978-1-4144-7091-4, pp. 1-4, August 2010 ([TR2010-078](#))
- Joshi, A.J.; Porikli, F.M., "Scene-Adaptive Human Detection with Incremental Active Learning", *International Conference on Pattern Recognition (ICPR)*, ISBN: 978-0-7695-4109-9, August 2010 ([TR2010-075](#))
- Li, X.; Porikli, F.M., "Human State Classification and Predication for Critical Care Monitoring by Real-Time Bio-signal Analysis", *International Conference on Pattern Recognition (ICPR)*, ISBN: 978-0-7695-4109-9, August 2010 ([TR2010-073](#))
- Porikli, F.M., "Learning on Manifolds", *Joint IAPR International Conference on Structural, Syntactic and Statistical Pattern Recognition (SSPR & SPR)*, August 2010 ([TR2010-079](#))
- * Shah, V.; Mehta, N.B.; Yim, R., "The Relay Selection and Transmission Trade-off in Cooperative Communication Systems", *IEEE Transactions on Wireless Communications*, ISSN: 1536-1276, Vol. 9, Issue 8, pp.: 2505-2515, August 2010 ([TR2010-106](#))

Yerazunis, W.S.; Kato, M.; Kori, M.; Shibata, H.; Hackenberg, K., "Keeping the Good Stuff In: Confidential Information Firewalling with the CRM114 Spam Filter & Text Classifier", *Black Hat Technical Security Conference*, July 2010 ([TR2010-064](#))

Rane, S.; Sun, W.; Vetro, A., "Privacy-Preserving Approximation of L1 Distance for Multimedia Applications", *IEEE International Conference on Multimedia and Expo (ICME)*, ISSN 1945-7871, pp. 492-497, July 2010 ([TR2010-077](#))

Wang, Y.; Lynch, A.F.; Bortoff, S.A., "On the Output Transformation to an Observer Form", *IASTED International Conference on Control and Applications*, July 2010 ([TR2010-074](#))

Research

The body and soul of any research lab is the portfolio of research it pursues. Therefore it is appropriate that the main body of this annual report consists of descriptions of research projects being done at MERL. For ease of reference, the reports are grouped into six topic areas.

Digital Communications - Advanced wireless and optical communications, highly reliable machine-to-machine networks, advanced coding/decoding, adaptive signal processing, smart grid standards and technologies, and emerging power electronics technologies for next generation systems.

Multimedia – Efficient representation, transmission, security, processing and interaction of multimedia; including video compression, display processing, information coding for security, compressive sensing, and speech processing.

Data Analytics – Predictive analytics (statistical machine learning, data analysis); Decision analytics (Optimization, scheduling and control); and software Infrastructure (distributed software systems, data stream processing).

Imaging - Detection, classification, and recognition based on machine learning and physical modeling; 3D characterization, reconstruction, location, and inference; computational imaging for optimized information capture; tracking and multi-modal sensor integration.

Mechatronics - Advanced control algorithms, system dynamics, modeling & performance analysis, mechatronics design, innovative system concepts, and 2D/3D adaptively-sampled distance fields applications.

Algorithms - Solution methods for optimization problems involving very large numbers of variables in the areas of information theory & coding; stochastic network utility maximization; sensing, perception, inference & learning.

Digital Communications

The world’s communications and information systems are rapidly accelerating their scale, scope and impact. Beyond traditional telecom offerings, new services and applications are emerging in nearly every vertical sector. As an example, revitalizing the electric power grid has become one of the top priorities worldwide. By integrating robust two-way communication, advanced sensors and distributed computing with the power transmission and distribution system, a “smart grid” can improve the efficiency, reliability and safety of power delivery and use. These developments are driving the growth in capacity and connectivity of the underlying infrastructure. These present major challenges and opportunities to digital communications.

The Digital Communications Group at MERL conducts research in the areas of next generation wireless and optical communications, reliable machine-to-machine networking, advanced signal processing and emerging power electronics technologies. We conduct not only applied research, but also fundamental research to develop breakthrough technologies. Our objectives are to improve spectral efficiency, increase system capacity, and achieve highly reliable networking for telecommunication infrastructures as well as other applications. We encourage innovation and creativity, close collaboration with universities and other research organizations, and contribute to international standards and the scientific community.

Responding to the new challenges, we have diversified our research effort on several fronts. We continue R&D on broadband communication technologies, especially precoding, interference management, multi-hop mesh networking and advanced coding/decoding. We are developing new technologies for high mobility systems; advanced signal processing algorithms for power equipment and systems; and are actively participating in smart grid international standardization activities. In addition, we are investigating emerging technologies, such as wireless power transfer.

Recent Research

Capacity, MSE and Secrecy Analysis of Linear Block Precoding for ...	34
Achieving Near-Exponential Diversity on Uncoded Low-Dimensional MIMO, ...	34
High-Order Super-Block GLRT for Non-Coherent Grassmann Codes in MIMO-OFDM ...	35
Effect of Transmission Parameters on Efficiency and Reliability of V2V Networks	35
Safety Message Transmission in Vehicular Communication Networks	36
Efficiency and Reliability of One-Hop Broadcasting in Vehicular Ad Hoc Networks	36
Digital Lane Marking for Geo-Information Dissemination	37
Fundamental Limits and Improved Algorithms for ... Wireless Position Estimation	37
Two-Step Low-Complexity Space-Time Adaptive Processing (STAP)	38
Wireless Power Transmission Efficiency Enhancement with Metamaterials	38
Electric Vehicles Network with Nomadic Portable Charging Stations	39

Capacity, MSE and Secrecy Analysis of Linear Block Precoding for Distributed Antenna Systems in Multi-user Frequency-Selective Fading Channels

Citation: Koike-Akino, T.; Molisch, A.F.; Duan, C.; Tao, Z.; Orlik, P.V., "Capacity, MSE and Secrecy Analysis of Linear Block Precoding for Distributed Antenna Systems in Multi-User Frequency-Selective Fading Channels", *IEEE Transactions on Communications*, ISSN: 0090-6773, Vol. 59, Issue 3, pp. 888, March 2011

Contacts: Toshiaki Koike-Akino, Chunjie Duan, Philip Orlik

Block transmission with cyclic prefix is a promising technique to realize high-speed data rates in frequency-selective fading channels. Many popular linear precoding schemes can be interpreted as such a block transmission. This paper presents a unified performance analysis that shows how the optimal precoding strategy depends on the optimization criterion such as capacity, mean-square error, and secrecy. We analyze three variants of TR methods (based on maximum-ratio combining, equal-gain combining and selective combining) and two-types of pre-equalization methods (zero-forcing and minimum mean-square error).

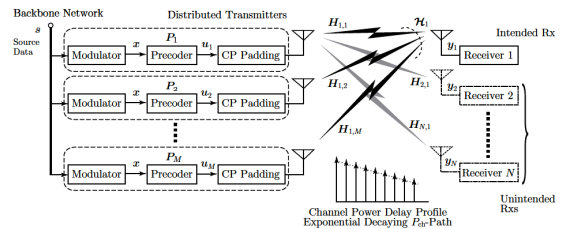

Fig. 1. Distributed antenna systems with linear block precoding for multi-user frequency-selective fading channels.

Achieving Near-Exponential Diversity on Uncoded Low-Dimensional MIMO, Multi-User and Multi-Carrier Systems Without Transmitter CSI

Citation: Annavajjala, R.; Orlik, P.V., "Achieving Near-Exponential Diversity on Uncoded Low-Dimensional MIMO, Multi-User and Multi-Carrier Systems Without Transmitter CSI", *IEEE Information Theory and Applications Workshop (ITA)*, ISBN 978-1-4577-0360, pp. 1-11, February 2011

Contacts: Philip Orlik

It is well-known that for single-input and single-output (SISO) narrow-band transmission on frequency-flat fading channels, uncoded communication with only receiver channel state information (Rx-CSI) leads to extremely poor reliability performance whereas transmitter CSI (Tx-CSI) allows us to approach the reliability of an additive white Gaussian noise (AWGN) channel via power control. In this paper, we propose a novel approach to achieve reliability close to the AWGN channel for uncoded transmissions on SISO frequency-flat Rayleigh fading channels without Tx-CSI. Our approach employs pseudo-random phase precoding (PRPP) of modulation symbols prior to temporal multiplexing, and joint-detection at the receiver that has polynomial complexity in the precoder size.

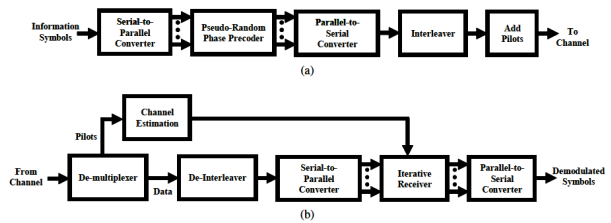

Fig. 1: Proposed pseudo-random phase precoder (PRPP) transmitter, Fig. 1a, and receiver, Fig. 1b.

High-Order Super-Block GLRT for Non-Coherent Grassmann Codes in MIMO-OFDM Systems

Citation: Koike-Akino, T.; Orlik, P.V., "High-Order Super-Block GLRT for Non-Coherent Grassmann Codes in MIMO-OFDM Systems", IEEE Global Telecommunications Conference (GLOBECOM), ISSN 1930-529X, pp. 1-6, December 2010

Contacts: Toshiaki Koike-Akino, Philip Orlik

We investigate non-coherent multi-input multi-output (MIMO) signal processing which requires no channel state information (CSI) at either the transmitter or the receiver. With non-coherent codes on Grassmann manifold, a receiver employing generalized likelihood ratio test (GLRT) algorithm offers the maximum-likelihood performance even without CSI. However, the conventional GLRT suffers from severe performance degradation when the channel changes fast within coding block duration. We propose an improved GLRT algorithm referred to as high-order super-block techniques. The super-block scheme makes effective use of correlated channels for adjacent blocks in slow fading, whereas the high-order scheme can overcome the channel fluctuation during a block in fast fading. We demonstrate that the proposed scheme significantly improves performance for MIMO-OFDM with non-coherent Grassmann space-frequency block codes (SFBC).

$$Y = HX + W, \quad (2)$$

Effect of Transmission Parameters on Efficiency and Reliability of V2V Networks

Citation: Yim, R.; Ye, F.; Roy, S.; Orlik, P.V., "Effect of Transmission Parameters on Efficiency and Reliability of V2V Networks", *ITS World Congress (ITS)*, October 2010

Contacts: Philip Orlik

Vehicle-to-vehicle communications is essential to create cooperative awareness amongst vehicles, improve roadway safety and roadway capacity, and reduce greenhouse gas emissions. As vehicle density increases, the amount of cooperative awareness messages also increases, which in turn increases the amount of background interference in the wireless channel. Transmission under high degree of background interference reduces the reliability of the packet. Adjusting transmission parameters such as transmission power or back off mechanism may reduce interference, but they also decrease efficiency of packet transmission. This paper quantifies the tradeoff between transmission efficiency and reliability, and shows how various transmission parameters affect overall system performance under different vehicle densities.

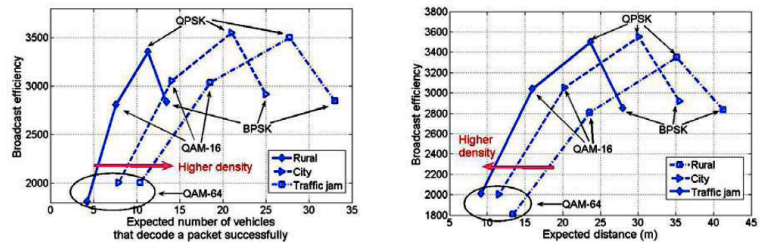

Figure 7 Tradeoff of broadcast efficiency and reliability due to modulation scheme. $c=0.05, p_0=27$ dBm, $L=512$ bits.

Safety Message Transmission in Vehicular Communication Networks

Citation: Guo, J.; Zhang, J., "Safety Message Transmission in Vehicular Communication Networks", *ITS World Congress (ITS)*, October 2010

Contacts: Jianlin Guo, Jinyun Zhang

Emerging vehicular safety applications require low latency communications and reliable packet dissemination for life saving safety messages. Significant developments have taken place over the past few years. IEEE WAVE and ISO CALM have been developed as international standards for ITS applications. Both WAVE and CALM support multichannel operations and use CSMA/CA as channel access mechanism. WAVE may impose a latency of 54 milliseconds for enabling multi-channel operations. CSMA/CA method can experience unpredictable delay and packet drop when channel is congested. In this paper, we propose an innovative technique to increase channel coverage and reduce latency for safety messages in multi-channel vehicular environments. We also propose an efficient congestion control protocol for vehicular communication networks that use CSMA/CA channel access mechanism. The proposed congestion control protocol guarantees that safety messages gain channel access while contending with other messages. Technologies presented in this paper improve reliability of the safety message dissemination and reduce latency for safety message transmission.

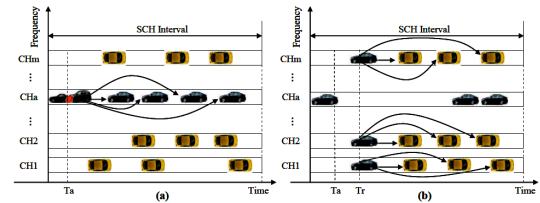

Figure 3. Safety Message Transmission in Multi-Channel Vehicular Communication Networks

Efficiency and Reliability of One-Hop Broadcasting in Vehicular Ad Hoc Networks

Citation: Ye, F.; Yim, R.; Roy, S.; Zhang, J., "Efficiency and Reliability of One-Hop Broadcasting in Vehicular Ad Hoc Networks", *IEEE Journal on Selected Areas in Communications*, ISSN: 0733-8716, Vol. 29, Issue 1, pp.: 151-160, January 2011

Contacts: Jinyun Zhang

In Dedicated Short Range Communications (DSRC) based vehicular networking, each vehicle periodically broadcasts control updates (that contain location and speed information etc.) to its neighbors, as a key component of traffic management and safety applications. The effectiveness of such a broadcast feature can be measured by two metrics: (1) the efficiency or the average rate (number of nodes per sec) to which a source can deliver its broadcast packets and (2) the reliability, or the average number of nodes that receive a specific transmission successfully. We demonstrate theoretical limits to and achievable trade-offs between efficiency and reliability for a linear network under Rayleigh fading links. We then provide power control and congestion control strategies that maximize broadcast efficiency. A strategy that achieves near-optimal broadcast efficiency when the network nodes have high mobility is also described. Ns-2 simulations are used to validate our analytical results.

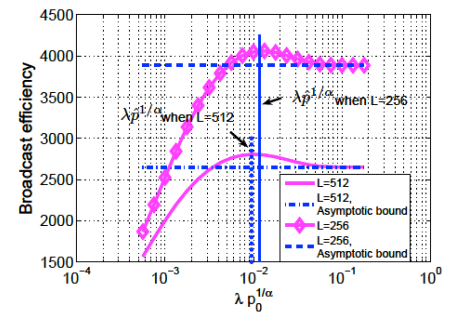

Figure 3. Broadcast efficiency as a function of $\lambda p_0^{1/\alpha}$. Maximum efficiency is achieved at $\lambda \hat{p}$, where \hat{p} is the optimal transmission power. $c = 0.05$, $p_{cs} = 3 n_0$.

Digital Lane Marking for Geo-Information Dissemination

Citation: Yim, R.; Saito, M.; Zhang, J., "Digital Lane Marking for Geo-Information Dissemination", *ITS World Congress (ITS)*, October 2010

Contacts: Jinyun Zhang

Roadway lane marking detection is essential for lane departure warning and enabling autonomous vehicles. Instead of using lane markings only as

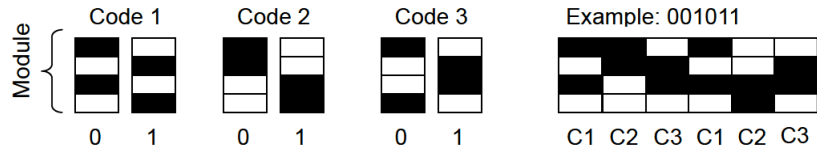

Figure 3 Differential Orthogonal Encoding

visual aids to indicate the boundary of two adjacent lanes, it is possible to also include digital information in the lane to provide geographically specific information. This enables in-tunnel navigation data, location-specific service advertisement, construction zone and lane merger warning. Technologically, such digital information should be decodable by inexpensive equipment, even while vehicle is travelling at highway speed. We propose a Differential Orthogonal Encoding scheme that allows information to be decoded even when the captured image of lane marking suffers from a high level of motion blur, and we show the superiority of the encoding scheme through physical experiment and theoretical analysis. A vehicle equipped with 1MP/cm² camera traveling at 30m/s (108km/h) can decode lane marking with data density of 77kb/m².

Fundamental Limits and Improved Algorithms for Linear Least-Squares Wireless Position Estimation

Citation: Guvenc, I.; Gezici, S.; Sahinoglu, Z., "Fundamental Limits and Improved Algorithms for Linea Least-Squares Wireless Position Estimation", *Wireless Communications and Mobile Computing*, DOI: 10.1002/wcm.1029, September 2010

Contacts: Zafer Sahinoglu

In this paper, theoretical lower bounds on performance of linear least-squares (LLS) position estimators are obtained, and

$$f_i(x, y) = \sqrt{(x - x_i)^2 + (y - y_i)^2}, \quad (2)$$

performance differences between LLS and nonlinear least-squares (NLS) position estimators are quantified. In addition, two techniques are proposed in order to improve the performance of the LLS approach. First, a reference selection algorithm is proposed to optimally select the measurement that is used for linearizing the other measurements in an LLS estimator. Then, a maximum likelihood approach is proposed, which takes correlations between different measurements into account in order to reduce average position estimation errors. Simulations are performed to evaluate the theoretical limits and to compare performance of various LLS estimators.

Two-Step Low-Complexity Space-Time Adaptive Processing (STAP)

Citation: Pun, M-O.; Sahinoglu, Z.; Shah, S.; Hara, Y.; Wang, P., "Two-Step Low-Complexity Space-Time Adaptive Processing (STAP)", *IEEE Global Telecommunications Conference (GLOBECOM)*, ISSN 1930-529X, pp. 1-5, December 2010

Contacts: Zafer Sahinoglu

This work proposes a low-complexity space-time adaptive processing (STAP) algorithm for sensing applications built on a moving platform in the presence of strong clutters. The proposed algorithm achieves low-complexity computation via two steps. First, it utilizes improved fast approximated power iteration methods to compress the data into a much smaller subspace. To further reduce the computational complexity, progressive singular value decomposition (SVD) approach is employed to update the inverse of the covariance matrix of the compressed data. As a result, the proposed low-complexity STAP algorithm can achieve order-of-magnitude computational complexity reduction as compared to conventional STAP algorithms. Simulation results are shown to confirm the validity of the proposed algorithm.

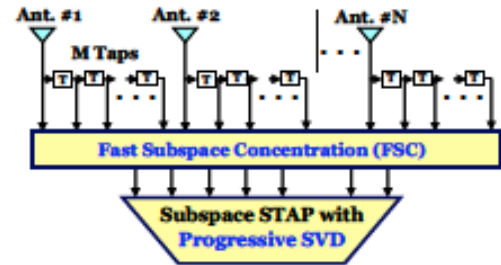

Fig. 3. Illustration of the proposed low-complexity two-step STAP.

Wireless Power Transmission Efficiency Enhancement with Metamaterials

Citation: Wang, B.; Nishino, T.; Teo, K.H., "Wireless Power Transmission Efficiency Enhancement with Metamaterials", *IEEE International Conference on Wireless Information Technology and Systems (ICWITS)*, ISBN 978-4-4244-7091-4, pp. 1-4, August 2010

Contacts: Bingnan Wang, Koon Hoo Teo

In this paper, a wireless power transfer system with magnetically coupled resonators is studied. The idea to use metamaterials to enhance the coupling coefficient and the transfer efficiency is proposed and analyzed. With numerical calculations of a system with and without metamaterials, we show that the transfer efficiency can be improved with metamaterials.

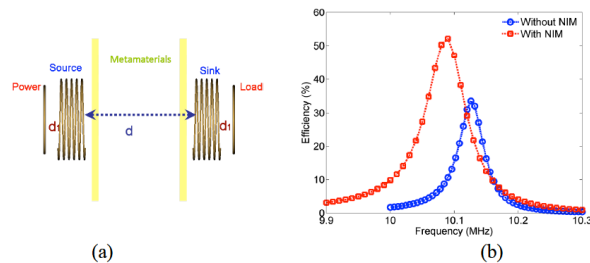

Figure 2 (a) An illustration of the wireless power transfer system model. The transmitter is composed of a power loop and a source coil resonator; the receiver is composed of a sink coil resonator and a load loop. For comparison, a new system is formed by adding NIM slabs to the system. (b) The calculated efficiency of system with and without the NIM slabs as a function of frequency.

Electric Vehicles Network with Nomadic Portable Charging Stations

Citation: Li, Z.; Sahinoglu, Z.; Tao, Z.; Teo, K.H., "Electric Vehicles Network with Nomadic Portable Charging Stations", *IEEE Vehicular Technology Conference (VTC)*, ISSN: 1090-3038, pp. 1-5, September 2010

Contacts: Zafer Sahinoglu, Koon-Hoo Teo

A novel concept of portable charging station networks to serve Electric Vehicles is described. An optimum charging station deployment method is explained, and its performance has been simulated for single highway, two intersecting highways, and Manhattan-like grid traffic models. Outage probability and service waiting delay performances are evaluated. Impact of the number PCSs and the ratio of EVs to PCSs in the service area on outage probability and waiting delay are studied. The gained insights will be used in extending this pioneer step to a stochastic framework with more realistic traffic models.

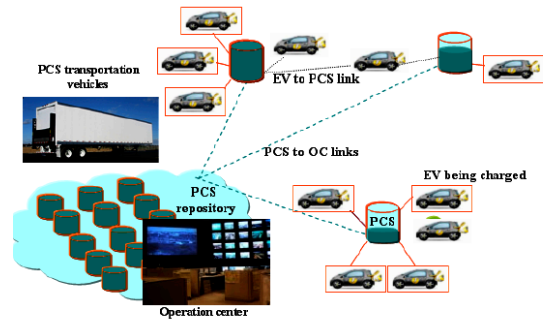

Fig. 1. Illustration of the portable EV charging station network concept. The thick dashed lines indicate communication links between the PCSs and the operation center. The thin dashed lines indicate communication links between PCSs and EVs.

Multimedia

Multimedia research at MERL is centered on the efficient representation, processing and security of multimedia as well as enhanced interactions with multimedia. Core technical strengths include digital video, information coding and speech/audio processing.

The digital video area includes both compression and display processing work. A key goal is to improve the compression efficiency of rich video formats including high resolution video formats, as well as multiview and 3D video. We also conduct research on the various display processing functions including video noise reduction and format conversions. Our research results are applied to international standards and across a wide range of audio-visual products. We also consider proprietary coding schemes that are applied to closed systems such as surveillance, airborne and space systems.

Our research in the area of information coding considers technology for both security and sensing applications. One major research initiative is on a class of technology to perform signal processing on encrypted data. This work supports a broad set of application from secure verification of encrypted biometric data to secure cloud computing. We are also exploring fundamental technology and applications of compressive sensing, including sampling and reconstruction techniques, for a wide range of industrial and consumer uses.

The work on speech and audio processing emphasizes spoken-language interfaces for automotive and handheld devices. We have developed core technology for voice-based retrieval of information. Other areas of work include speech enhancement and technology that aims to improve multimodal interfaces. Our work in this area has been primarily applied to car navigation products.

Recent Research

Robust Learning of 2-D Separable Transforms for Next-Generation Video Coding.....	42
Depth Coding Using a Boundary Reconstruction Filter for 3-D Video Systems.....	42
Democracy in Action: Quantization, Saturation and Compressive Sensing.....	43
Privacy Preserving String Comparisons Based on Levenshtein Distance.....	43
Multiparty Differential Privacy via Aggregation of Locally Trained Classifiers.....	44
Wyner-Ziv Coding of Multispectral Images for Space and Airborne Platforms.....	44
Compressive Sensing for Streaming Signals using the Streaming Greedy Pursuit.....	45
On Unconditionally Secure Computation with Vanishing Communication Cost.....	45
Direction-Adaptive Transforms for Coding Prediction Residuals.....	46
Streaming Compressive Sensing for High-Speed Periodic Videos.....	46
Occlusion Handling Based on Support and Decision.....	47
Vocabulary Independent Spoken Query: A Case for Subword Units.....	47
Contextual Push-to-talk: Shortening Voice Dialogs to Improve Driving Performance.....	48
Privacy-Preserving Approximation of L1 Distance for Multimedia Applications.....	48

Robust Learning of 2-D Separable Transforms for Next-Generation Video Coding

Citation: Sezer, O.G.; Cohen, R.A.; Vetro, A., "Robust Learning of 2-D Separable Transforms for Next-Generation Video Coding", *Data Compression Conference*, March 2011

Contacts: Robert Cohen, Anthony Vetro

With the simplicity of its application together with compression efficiency, the Discrete Cosine Transform (DCT) plays a vital role in the development of video compression standards. For next-generation video coding, a new set of 2-D separable transforms has emerged as a candidate to replace the DCT. These separable transforms are learned from residuals of each intra prediction mode; hence termed as Mode dependent- directional transforms (MDDT). MDDT uses the Karhunen-Loeve Transform (KLT) to create sets of separable transforms from training data. Since the residuals after intra prediction have some structural similarities, transforms utilizing these correlations improve coding efficiency. However, the KLT is the optimal approach only if the data has a Gaussian distribution without outliers. Due to the nature of the least-square norm, outliers can arbitrarily affect the directions of the KLT components. In this paper, we will address robust learning of separable transforms by enforcing sparsity on the coefficients of the representations. With this new approach, it is possible to improve upon the video coding performance of H.264/AVC by up to 10.2% BD-rate for intra coding. At no additional cost, the proposed techniques can also provide up to 3.9% improvement in BD-rate for intra coding compared to existing MDDT schemes.

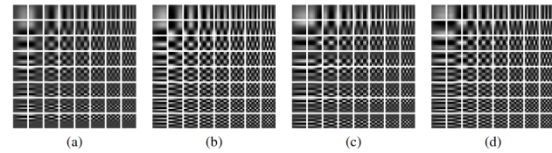

Fig. 3. Comparison of separable transforms of MDST and MDDT. MDST of vertical prediction (mode 0) (a), MDDT of vertical prediction (mode 0) (b), MDST of horizontal prediction (mode 1) (c), MDDT of horizontal prediction (mode 1) (d).

Depth Coding Using a Boundary Reconstruction Filter for 3-D Video Systems

Citation: Oh, K.-J.; Vetro, A.; Ho, Y.-S., "Depth Coding Using a Boundary Reconstruction Filter for 3-D Video Systems", *IEEE Transactions on Circuits and Systems for Video Technology*, ISSN: 1051-8215, Vol. 21, Issue 3, pp. 350, March 2011

Contacts: Anthony Vetro

A depth image is three-dimensional (3D) information used for virtual view synthesis in 3D video system. In depth coding, the object boundaries are hard to compress and severely affect the rendering quality since they are sensitive to coding errors. In this paper, we propose a depth boundary reconstruction filter and utilize it as an in-loop filter to code the depth video. The proposed depth boundary reconstruction filter is designed considering occurrence frequency, similarity, and closeness of pixels. Experimental results demonstrate that the proposed depth boundary reconstruction filter is useful for efficient depth coding as well as high-quality 3D rendering.

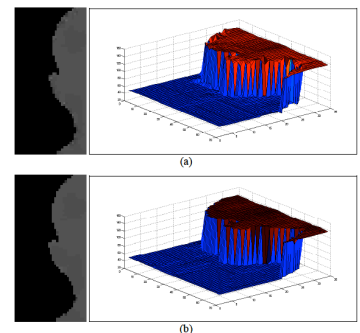

Fig. 7. Result images for the depth boundary reconstruction filter: (a) before depth boundary reconstruction, (b) after depth boundary reconstruction.

Democracy in Action: Quantization, Saturation and Compressive Sensing

Citation: Laska, J.N.; Boufounos, P.T.; Davenport, M.A., Baraniuk, R.G., "Democracy in Action: Quantization, Saturation and Compressive Sensing", *Applied and Computational Harmonic Analysis*, February 2011

Contacts: Petros Boufounos

Recent theoretical developments in the area of compressive sensing (CS) have the potential to significantly extend the capabilities of digital data acquisition systems such as analog-to-digital converters and digital imagers in certain applications. To date, most of the CS literature has been devoted to studying the recovery of

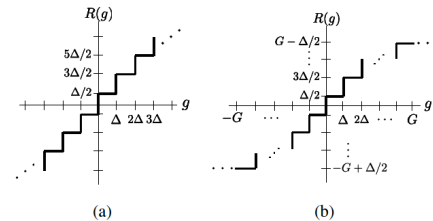

Figure 1: (a) Midrise scalar quantizer. (b) Finite-range midrise scalar quantizer with saturation level G .

sparse signals from a small number of linear measurements. In this paper, we study more practical CS systems where the measurements are quantized to a finite number of bits; in such systems some of the measurements typically saturate, causing significant nonlinearity and potentially unbounded errors. We develop two general approaches to sparse signal recovery in the face of saturation error. The first approach merely rejects saturated measurements; the second approach factors them into a conventional CS recovery algorithm via convex consistency constraints. A series of computational experiments indicate that the signal acquisition error is minimized when a significant fraction of the CS measurements are allowed to saturate (10-30% in our experiments). This challenges the conventional wisdom of both conventional sampling and CS.

Privacy Preserving String Comparisons Based on Levenshtein Distance

Citation: Rane, S.; Sun, W., "Privacy Preserving String Comparisons Based on Levenshtein Distance", *IEEE International Workshop on Information Forensics and Security (WIFS)*, ISBN 978-1-4244-9078-3, pp. 1-6, December 2010

Contacts: Shantanu Rane, Wei Sun

Alice and Bob possess strings x and y of length m and n respectively and want to compute the Levenshtein distance $L(x, y)$ between the strings under privacy and communication constraints. The Levenshtein, or edit, distance has a dynamic programming formulation that solves a series of minimum finding problems. Based on this formulation, there are known symmetric privacy-preserving protocols for the computation of $L(x, y)$, in which the two parties incur equal protocol overhead. In this work, we propose an asymmetric two-party protocol in which a lightweight client Bob with a string y interacts with a single powerful server Alice containing string x in its database. While Alice requires similar effort as in previous approaches, the advantage is that Bob incurs far fewer cipher text operations and transmissions, making the protocol well-suited for client-server querying applications.

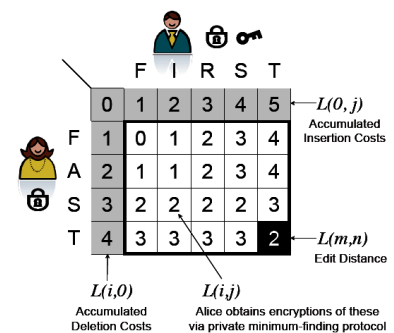

Fig. 1. An example of edit distance computation, in which Alice owns the string FAST and Bob owns the string FIRST. In our asymmetric setup, only Bob, the end-user possesses the decryption key for additively homomorphic encryption. Alice, the server, computes the encryptions of $L(i, j)$ via an interactive protocol that will be described in the subsequent sections.

Multiparty Differential Privacy via Aggregation of Locally Trained Classifiers

Citation: Pathak, M.; Rane, S.; Raj, B., "Multiparty Differential Privacy via Aggregation of Locally Trained Classifiers", *Neural Information Processing Systems (NIPS)*, December 2010
 Contacts: Shantanu Rane

As increasing amounts of sensitive personal information finds its way into data repositories, it is important to develop analysis mechanisms that can derive aggregate information from these repositories without revealing information about individual data instances. Though the differential privacy model provides a framework to analyze such mechanisms for databases belonging to a single party, this framework has not yet been considered in a multi-party setting. In this paper, we propose a privacy-preserving protocol for composing a differentially private aggregate classifier using classifiers trained locally by separate mutually untrusting parties. The protocol allows these parties to interact with an untrusted curator to construct additive shares of a perturbed aggregate classifier. We also present a detailed theoretical analysis containing a proof of differential privacy of the perturbed aggregate classifier and a bound on the excess risk introduced by the perturbation. We verify the bound with an experimental evaluation on a real dataset.

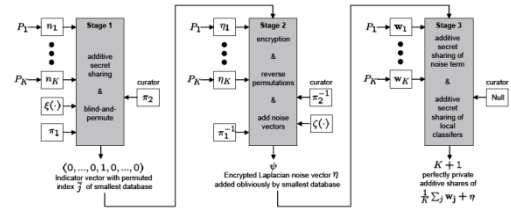
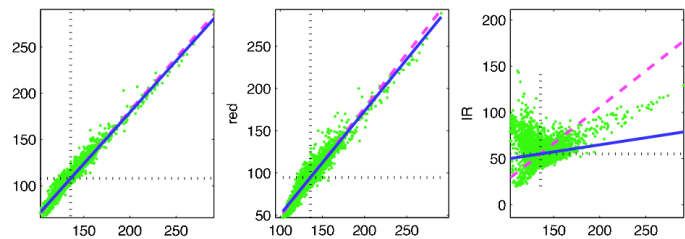

Figure 1: Multiparty protocol to securely compute additive shares of \hat{w} .

Wyner-Ziv Coding of Multispectral Images for Space and Airborne Platforms

Citation: Rane, S.; Wang, Y.; Boufounos, P.T.; Vetro, A., "Wyner-Ziv Coding of Multispectral Images for Space and Airborne Platforms", *Picture Coding Symposium (PCS)*, ISBN 978-1-4244-7134-8, pp. 234-237, December 2010
 Contacts: Shantanu Rane, Yebin Wang, Petros Boufounos, Anthony Vetro

This paper investigates the application of lossy distributed source coding to high resolution multispectral images. The choice of distributed source coding is motivated by the need for very low encoding complexity on space and airborne platforms. The data consists of red, blue, green and infra-red channels and is compressed in an asymmetric Wyner-Ziv setting. One image channel is compressed using traditional JPEG and transmitted to the ground station where it is available as side information for Wyner-Ziv coding of the other channels. At the ground station, the image data is recovered from the syndromes by exploiting the correlation in the frequency spectrum of the band being decoded and the JPEG-decoded side information band. In experiments with real uncompressed images obtained by a satellite, the rate-distortion performance is found to be vastly superior to JPEG compression of individual image channels and rivals that of JPEG2000 at much lower encoding complexity.



Compressive Sensing for Streaming Signals using the Streaming Greedy Pursuit

Citation: Rane, S.D.; Sun, W.; Vetro, A., "Secure Distortion Computation between Untrusting Parties using Homomorphic Encryption", *IEEE International Conference on Image Processing (ICIP)*, DOI: 10.1109/ICIP.2009.5414544, pp. 1485-1588, November 2009

Contacts: Shantanu Rane, Wei Sun, Anthony Vetro

Compressive Sensing (CS) has recently emerged as significant signal processing framework to acquire and reconstruct sparse signals at rates significantly below the Nyquist rate. However, most of the CS development to-date has focused on finite-length signals and representations. In this paper we present a new CS framework and a greedy reconstruction algorithm, the Streaming Greedy Pursuit (SGP), explicitly designed for streaming applications and signals of unknown length. Our sampling framework is designed to be causal and implementable using existing hardware architectures. Furthermore, our reconstruction algorithm provides explicit computational guarantees, which makes it appropriate for real-time system implementations. Our experimental results on very long signals demonstrate the good performance of the SGP and validate our approach.

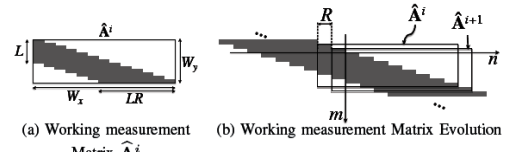

Fig. 4. The working measurement matrix and its correspondence with the measurement system response.

On Unconditionally Secure Computation with Vanishing Communication Cost

Citation: Wang, Y.; Rane, S.; Sun, W.; Ishwar, P., "On Unconditionally Secure Computation with Vanishing Communication Cost", *Allerton Conference on Communication, Control and Computing*, DOI: 10.1109/ALLERTON.2010.5707010, September 2010

Contacts: Yebin Wang, Shantanu Rane, Wei Sun

We propose a novel distortion-theoretic approach to a secure three-party computation problem. Alice and Bob have deterministic sequences, and Charlie wishes to compute a normalized sum-type function of those sequences. We construct three-party protocols that allow Charlie to compute the function with arbitrarily high accuracy, while maintaining unconditional privacy for Alice and Bob and achieving vanishing communication cost. This work leverages a striking dimensionality reduction that allows a high accuracy estimate to be produced from only random subsampling of the sequences. The worst-case distortion of the estimate, across all arbitrary deterministic sequences of any length, is independent of the dimensionality (length) of the sequences and proportional to inverse square root of the number of samples that the estimate is based upon.

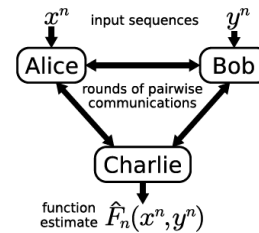

Fig. 1. Alice and Bob are given deterministic sequences x^n and y^n . The three parties then execute a protocol consisting of multiple rounds of local computations and pairwise communications. At the end of the protocol, Charlie produces an estimate of a function of the sequences, $\hat{F}_n(x^n, y^n)$.

Direction-Adaptive Transforms for Coding Prediction Residuals

Citation: Cohen, R.A.; Klomp, S.; Vetro, A.; Sun, H., "Direction-Adaptive Transforms for Coding Prediction Residuals", *IEEE International Conference on Image Processing (ICIP)*, ISSN 1522-4880, pp. 185-188, September 2010

Contacts: Robert Cohen, Anthony Vetro, Huifang Sun

In this paper, we present 2-D direction-adaptive transforms for coding prediction residuals of video. These Direction-Adaptive Residual Transforms (DART) are shown to be more effective than the traditional 2-D DCT when coding residual blocks that contain directional features. After presenting the directional transform structures and improvements to their efficiency, we outline how they are used to code both Inter and Intra prediction residuals. For Intra coding, we also demonstrate the relation between the prediction mode and the optimal DART orientation. Experimental results exhibit up to 7% and 9.3% improvements in compression efficiency in JM 16.0 and JM-KTA 2.6r1 respectively, as compared to using only the conventional H.264/AVC transform.

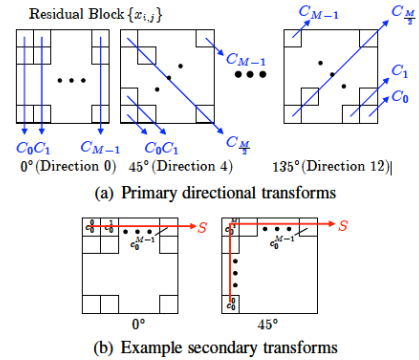

Fig. 1. Direction-Adaptive Residual Transform

Streaming Compressive Sensing for High-Speed Periodic Videos

Citation: Asif, M.S.; Reddy, D.; Boufounos, P.T.; Veeraraghavan, A., "Streaming Compressive Sensing for High-Speed Periodic Videos", *IEEE International Conference on Image Processing (ICIP)*, ISSN 1522-4880, pp. 3373-3376, September 2010

Contacts: Petros Boufounos

The ability of Compressive Sensing (CS) to recover sparse signals from limited measurements has been recently exploited in computational imaging to acquire high-speed periodic and near-periodic videos using only a low-speed camera with coded exposure and intensive off-line processing. Each low-speed frame integrates a coded sequence of high-speed frames during its exposure time. The high-speed video can be reconstructed from the low-speed coded frames using a sparse recovery algorithm. This paper presents a new streaming CS algorithm specifically tailored to this application. Our streaming approach allows causal on-line acquisition and reconstruction of the video, with a small, controllable, and guaranteed buffer delay and low computational cost. The algorithm adapts to changes in the signal structure and, thus, outperforms the off-line algorithm in realistic signals.

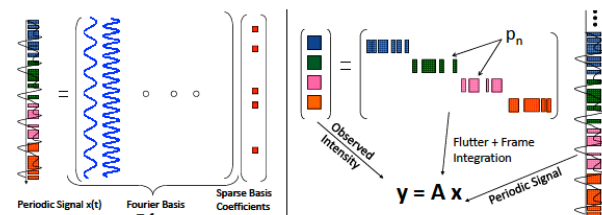

Fig. 1. (Left) Snapshot of signal sparsity model. (Right) Snapshot of coded strobing system.

Occlusion Handling Based on Support and Decision

Citation: Min, D.; Yea, S.; Vetro, A., "Occlusion Handling Based on Support and Decision", *IEEE International Conference on Image Processing (ICIP)*, ISSN 1522-4880, pp.1777-1780, September 2010

Contacts: Anthony Vetro

This paper proposes a novel method for handling occluded pixels in stereo images based on a probabilistic voting framework that utilizes a novel support-and-decision process. Occlusion handling aims to assign a reasonable disparity value to occluded pixels in the disparity maps. In an initial step, disparities and their corresponding supports at the occluded pixels are calculated using a probabilistic voting method using the disparities at visible pixels. In this way, the visible pixel information is propagated when the disparities and support at the occluded pixels are computed. The final disparities for occluded pixels are then computed through an iterative support-and-decision process to propagate the information inside the occluded pixel region. An acceleration technique is also proposed to improve the performance of the iterative support-and-decision process. Experimental results show that the proposed occlusion handling method works well for several challenging stereo images.

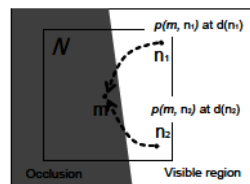

Fig. 1. Computation of support function in probabilistic framework.

Vocabulary Independent Spoken Query: A Case for Subword Units

Citation: Gouvea, E.; Ezzat, T., "Vocabulary Independent Spoken Query: a Case for Subword Units", *Interspeech*, September 2010

Contacts:

In this work, we describe a subword unit approach for information retrieval of items by voice. An algorithm based on the minimum description length (MDL) principle converts an index written in terms of words into an index written in terms of phonetic subword units. A speech recognition engine that uses a language model and pronunciation dictionary built from such an inventory of subword units is completely independent from the information retrieval task. The recognition engine can remain fixed, making this approach ideal for resource constrained systems. In addition, we demonstrate that recall results at higher out of vocabulary (OOV) rates are much superior for the subword unit system. On a music lyrics task at 80% OOV, the subword-based recall is 75.2%, compared to 47.4% for a word system.

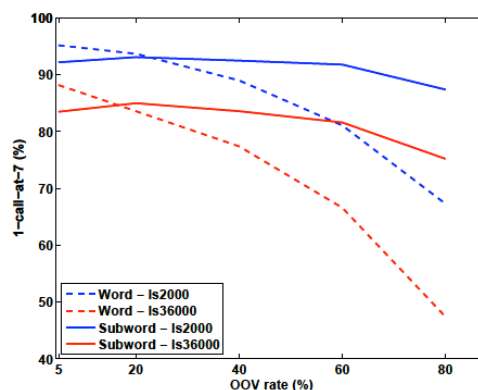

Figure 5: Recall for indices of different sizes as OOV rate changes. The subword unit inventory has 1200 units.

Contextual Push-to-talk: Shortening Voice Dialogs to Improve Driving Performance

Citation: Weinberg, G.; Harsham, B.; Forlines, C.; Medenica, Z., "Contextual Push-to-talk: Shortening Voice Dialogs to Improve Driving Performance", *International Conference on Human Computer Interaction with Mobile Devices and Services (MOBILEHCI)*, ISBN: 978-1-60558-835-3, pp. 113-122, September 2010

Contacts: Bret Harsham

We present a driving simulator-based evaluation of a new technique for simplifying in-vehicle device interactions and thereby improving driver safety. We show that the use of multiple, contextually linked push-to-talk buttons (Multi-PTT) shortens voice dialog duration versus the use of a conventional, single push-to-talk button (Single-PTT). This benefit comes without detriment to driving performance or visual attention to the forward roadway. Test subjects also preferred the Multi-PTT approach over the conventional approach, and reported that it imposed a lower cognitive workload.

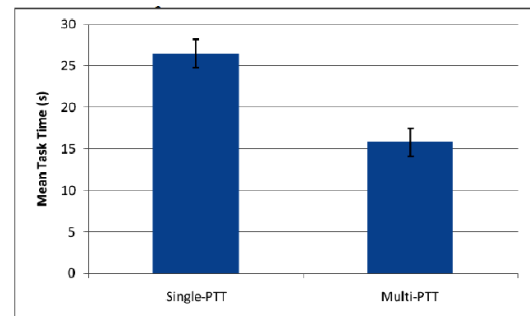

Figure 4. Mean task times for each *interaction-technique*. Error bars represent 95% confidence intervals in all figures.

Privacy-Preserving Approximation of L1 Distance for Multimedia Applications

Citation: Rane, S.; Sun, W.; Vetro, A., "Privacy-Preserving Approximation of L1 Distance for Multimedia Applications", *IEEE International Conference on Multimedia and Expo (ICME)*, ISSN 1945-7871, pp. 492-497, July 2010

Contacts: Shantanu Rane, Wei Sun, Anthony Vetro

Alice and Bob possess sequences \mathbf{x} and \mathbf{y} respectively and would like to compute the ℓ_1 distance, namely $\|\mathbf{x} - \mathbf{y}\|_1$ under privacy and communication constraints. The privacy constraint requires that Alice and Bob do not reveal their data to each other. The communication constraint requires that they accomplish the secure distance calculation with a small number of protocol transmissions and key exchanges. This paper describes and analyzes a privacy-preserving approximation protocol for the ℓ_1 distance that keeps the communication overhead manageable by performing a Johnson-Lindenstrauss embedding into the ℓ_2 space. Then, it performs secure two-party computation of ℓ_2 distances using Paillier *homomorphic* encryption. The protocol is implemented for private querying of face images, while maintaining a low communication overhead between the querying party and a remote database of face feature vectors.

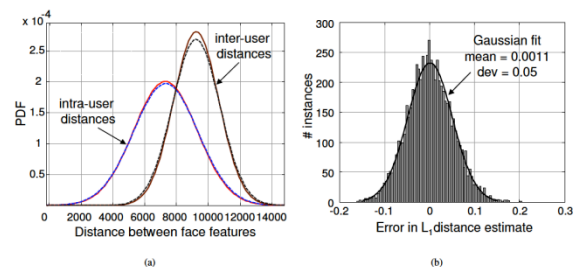

Fig. 2. (a) The probability distributions of the inter-user and intra-user distances calculated using the proposed approximation scheme are very close to the true probability distributions. (b) A histogram of the error between the actual ℓ_1 distance and its secure approximation computed for 6000 randomly chosen pairs. The mean error is 0.0011 and its standard deviation is 0.05.

Data Analytics

Data Analytics technologies aim to improve the performance of devices, systems, and business processes by means of collecting data, constructing predictive models from that data, and making improved decisions based on the constructed models. The Data Analytics group at MERL has been working on both predictive and decision analytics, as well as supporting fields such as signal processing, numerical methods, and information systems infrastructure. The focus of the group is on innovative high-performance algorithms that can be applied to various product lines of Mitsubishi Electric, including air conditioners, electrical power systems, transportation systems, and enterprise information technology. The application of these algorithms minimizes costs, maximizes profits, increases reliability, improves energy efficiency, and reduces environmental impact of products.

Research on predictive analytics, supported by advances in the field of statistical machine learning, aims to create accurate data-driven models of electromechanical and thermodynamical systems, as well as models for data managed by enterprise information systems. The developed algorithms for non-linear regression, gray-box systems identification, time series prediction, exemplar learning, abrupt change detection, video highlight extraction, memory-based classification, automatic database schema matching, sequential recommendation, and business process mining are among the best in their class.

Research on decision analytics and optimization combines the predictive models learned from data with large-scale optimization methods for planning and scheduling in large problem spaces. Under investigation are formalisms for sequential decisionmaking such as factored Markov decision process models, stochastic Petri nets, and mixed integer programming, with applications to optimal scheduling and control.

Numerical methods for fast solution of network problems find application in the analysis of electrical power systems and Smart Grids that include renewable power sources with intermittent output, as well as highly variable loads such as electrical vehicles. In addition, research on supporting technologies such as signal processing has resulted in algorithms for dimensionality reduction and feature extraction based on non-negative matrix factorization and independent component analysis. These methods, combined with predictive and decision algorithms, will lead to a new breed of technology and systems for improved decision making based on data analysis.

Recent Research

Factored Markov Decision Process Models for Stochastic Unit Commitment	50
A Park Transform-Based Method for Condition Monitoring of Three-Phase	50
Spectrogram Dimensionality Reduction with Independence Constraints	51
A Two-Step Method for Estimating the Parameters of Induction Machine Models	51
Probabilistic Inter-disturbance Interval Estimation for Bearing Fault Diagnosis.....	52
Memory-Based Modeling of Seasonality for Prediction of Climatic Time Series.....	52
Fast Adaptive Algorithms for Abrupt Change Detection	53
Optical Performance Monitoring via Histogram: A Data-Driven Approach.....	53

Factored Markov Decision Process Models for Stochastic Unit Commitment

Citation: Nikovski, D.; Zhang, W., "Factored Markov Decision Process Models for Stochastic Unit Commitment", *IEEE Conference on Innovative Technologies for an Efficient and Reliable Electricity Supply (CITRES)*, ISBN 978-1-4244-6076-2, pp. 28-35, September 2010

Contacts: Daniel Nikovski

In this paper, we consider stochastic unit commitment problems where power demand and the output of some generators are random variables. We represent stochastic unit commitment problems in the form of factored Markov decision process models, and propose an approximate algorithm to solve such models. By incorporating a risk component in the cost function, the algorithm can achieve a balance between the operational costs and blackout risks. The proposed algorithm outperformed existing non-stochastic approaches on several problem instances, resulting in both lower risks and operational costs.

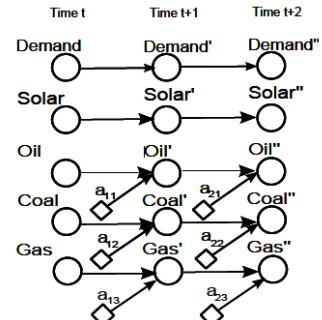

Figure II.1. DBN for a power generation problem with three controllable and one uncontrollable power generators.

A Park Transform-Based Method for Condition Monitoring of Three-Phase Electromechanical Systems

Citation: Laughman, C.R.; Lesh, S.B.; Norford, L.K.; Shaw, S.R.; Armstrong, P.R., "A Park Transform-Based Method for Condition Monitoring of Three-Phase Electromechanical Systems", *Power Electronics Machines and Drives (PEMD)*, April 2010

Contacts: Christopher Laughman

This paper presents a Park transform-based method for processing stator current data from a motor and transforming it into a form that is useful for fault detection and diagnostics. The proposed method generates power signatures that are invariant to the initial electrical angle of the voltage when the motor is connected to the utility, and can also adapt to variation in the electrical angle of the supply voltage over time. A modified nonlinear least squares algorithm identifies and tracks the parameters of the supply voltage over time, ensuring that the supply voltage and the argument of the Park transformation remain synchronized. Experimental results are presented that illustrate the method's effectiveness for identifying changes in the mechanical load on a 3/4 HP refrigeration compressor.

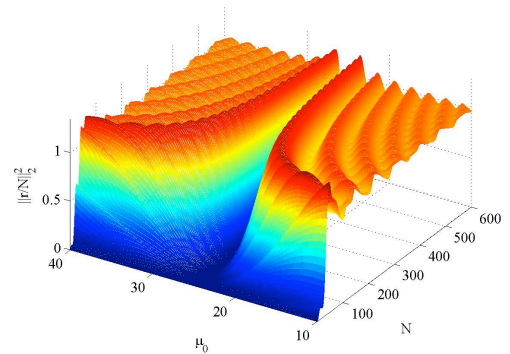

Spectrogram Dimensionality Reduction with Independence Constraints

Citation: Wilson, K.W.; Raj, B., "Spectrogram Dimensionality Reduction with Independence Constraints", *IEEE International Conference on Acoustics, Speech and Signal Processing (ICASSP)*, MLSP-L4.3, March 2010

Contacts: Kevin Wilson

We propose an algorithm to find a low-dimensional decomposition of a spectrogram by formulating this as a regularized non-negative matrix factorization (NMF) problem with a regularization term chosen to encourage independence. This algorithm provides a better decomposition than standard NMF when the underlying sources are independent. It makes better use of additional observation streams than previous nonnegative ICA algorithms.

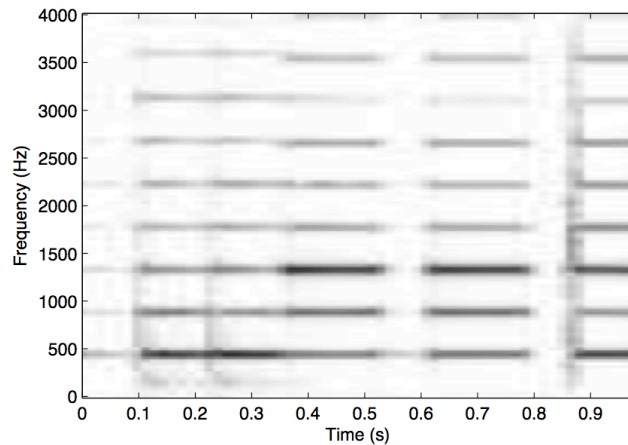

A Two-Step Method for Estimating the Parameters of Induction Machine Models

Citation: Laughman, C.R.; Leeb, S.B.; Norford, L.K.; Shaw, S.R.; Armstrong, P.R., "A Two-Step Method for Estimating the Parameters of Induction Machine Models", *IEEE Energy Conversion Congress and Exposition (ECCE)*, DOI: 10.1109/ECCE.2009.5316204, pp. 262-269, September 2009

Contacts: Christopher Laughman

This paper describes and demonstrates a mathematical algorithm that can monitor the physical parameters of the motor solely by observing the stator electrical currents. This method uses measurements of transient stator currents to identify the parameters of an electromechanical model of the induction motor. These parameters are obtained from a relatively poor initial guess, which is constrained only to be within an order of magnitude of the physical parameters, by using a two-step strategy based upon nonlinear least-squares regression techniques. This makes the approach in this paper useful for diagnostic monitoring and energy scorekeeping. Experimental results are presented which demonstrate the effectiveness of this method on identifying the parameters of a 1 HP induction motor connected to a squirrel cage fan in an air-handling unit.

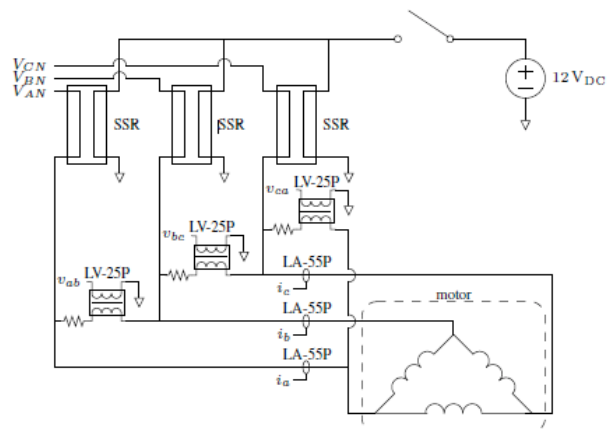

Probabilistic Inter-disturbance Interval Estimation for Bearing Fault Diagnosis

Citation: Wilson, K.W.; “Probabilistic Inter-disturbance Interval Estimation for Bearing Fault Diagnosis”, IEEE International Symposium on Diagnostics for Electric Machines, Power Electronics and Drives (SDEMPED), DOI: 10.1109/DEMPED.2009.5292803, pp. 1-6, August 2009

Contacts: Kevin Wilson

We describe a new method for detecting characteristic bearing fault signatures from accelerometer vibration data based on a probabilistic model of the fault signal generation process. It is common to assume that single-point bearing defects cause periodic disturbances in bearing vibration signals, but this assumption may not be valid in practice. Our new method is less sensitive to departures from periodicity, such as fault disturbance amplitude and timing variations, than standard spectral or autocorrelation-based approaches. We demonstrate the utility of our method by distinguishing among inner race, outer race, and rolling element faults in a bearing fault test rig. Our method is significantly better than standard techniques at detecting rolling element (ball) faults.

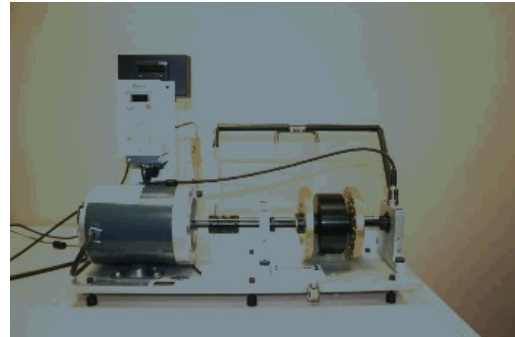

Memory-Based Modeling of Seasonality for Prediction of Climatic Time Series

Citation: Nikovski, D.N.; Ramachandran, G., “Memory-Based Modeling of Seasonality for Prediction of Climatic Time Series”, *Lecture Notes in Computer Science*, ISSN 0302-9743, Vol. 5632/2009, pp. 734-748, July 2009

Contacts: Daniel Nikovski

The paper describes a method for predicting climate time series that consist of significant annual and diurnal seasonal components and a short-term stochastic component. A memory-based method for modeling of the non-linear seasonal components is proposed that allows the application of simpler linear models for predicting short-term deviations from seasonal averages. The proposed method results in significant reduction of prediction error when predicting error time series of ambient air temperature from multiple locations.

Moreover, combining the statistical predictor with meteorological forecasts using linear regression or Kalman filtering further reduces error to typically between 1°C over a prediction horizon of one hour and 2.5 °C over 24 hours.

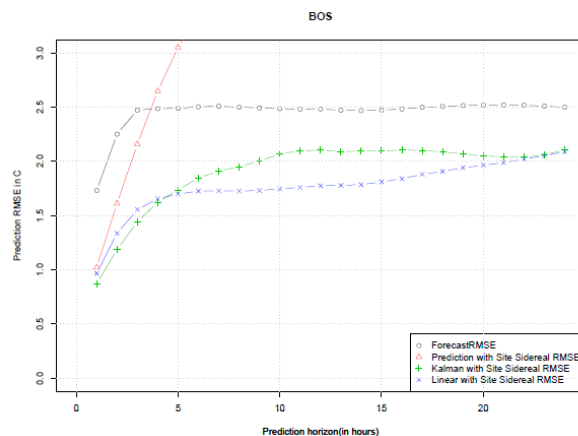

Fast Adaptive Algorithms for Abrupt Change Detection

Citation: Nikovski, D.N.; Jain, A., "Fast Adaptive Algorithms for Abrupt Change Detection", *Machine Learning*, ISSN 0885-6125; DOI 10.1007/s10994-009-5122-x, July 2009

Contacts: Daniel Nikovski

We propose two fast algorithms for abrupt change detection in streaming data that can operate on arbitrary unknown data distributions before and after the change. The first algorithm, MB-GT, computes efficiently the average Euclidean distance between all pairs of data points before and after the hypothesized change. The second algorithm, MB-CUSUM, computes the log-likelihood ratio statistic for the data distributions before and after the change, similarly to the classical CUSUM algorithm, but unlike that algorithm, MB-CUSUM does not need to know the exact distributions, and uses kernel density estimates instead. Although a straightforward computation of the two change statistics would have computational complexity of $O(N^4)$ with respect to the size N of the streaming data buffer, the proposed algorithms are able to use the computational structure of these statistics to achieve a computational complexity of only $O(N^2)$ and memory requirement of $O(N)$. Furthermore, the algorithms perform surprisingly well on dependent observations generated by underlying dynamical systems, unlike traditional change detection algorithms.

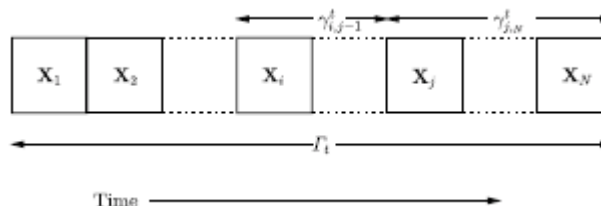

Optical Performance Monitoring via Histogram: A Data-Driven Approach

Citation: Wen, Y.; Wilson, K.W., "Optical Performance Monitoring via Histogram: A Data-Driven Approach", *Opto Electronics and Communications Conference (OECC)*, DOI: 10.1109/oecc.2009.5222713, pp.1-2, July 2009

Contacts: Kevin Wilson

We apply three alternative statistical learning methods to estimate optical transmission impairments (e.g., noises, chromatic dispersion) from synchronous histograms. Linear regression yields good accuracy. A more sophisticated locally weighted regression technique performs better.

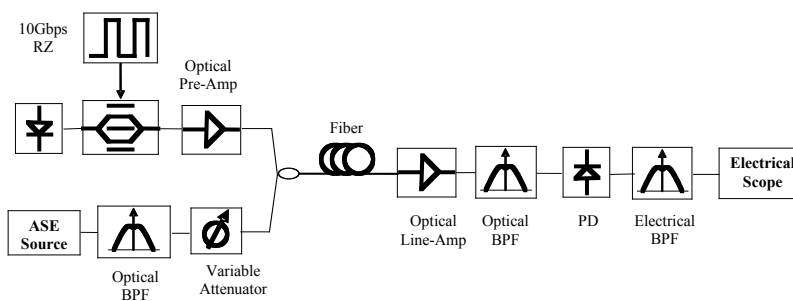

Imaging

The research in the Imaging group at MERL covers all aspects of extracting information from images. For instance, from a picture of a scene we can compute features that allow the detection and location of specific objects. Or we learn a dictionary for the appearance of local patches in an image and use it to classify regions and objects or to improve the image quality. We can track a moving object in video to quantify its trajectory. In some cases we can modify the actual image creation process to make subsequent information extraction more effective. For instance, multiple flash exposures can be used to identify an object's edges.

Several of our current projects involve 3D analysis based on 2D images. For example, we have developed algorithms for estimation of object pose so that a robot arm can grasp an object from a cluttered workspace. In another project, we infer automobile position in a city through matching of camera images to a 3D city model. For medical radiation treatment, we align patient position by matching current x-rays to simulated x-rays obtained by project. In all these cases, the algorithms we have developed must be very fast and accurate. We have also developed algorithms that operate directly on 3D data for reconstruction, detection, and recognition.

Other projects depend on developing novel models and features to support accurate detection, classification, and recognition based on machine learning. Our work on face detection and recognition is well-known, and we have produced world class results in other forms of detection and classification for human and other objects.

For several years, MERL has been a leader in computational photography and imaging. Given that many images are now computer processed prior to viewing, this research seeks to modify the capture stage to optimize the information transfer into the computer and ultimately into the final usage—perhaps human viewing, or perhaps more computer analysis to extract quantitative measures from the image. In this research MERL has been able to dramatically improve corrections for motion and focus blur, achieve spatial and temporal super-resolution in video, and conceive novel camera optics for wide field of view stereo reconstruction.

Recent Research

Morphable Reflectance Fields for Enhancing Face Recognition	56
Fast Directional Chamfer Matching.....	56
Breaking the Interactive Bottleneck in Multi-Class Classification with Active	57
RelCom: Relational Combinatorics Features for Rapid Object Detection	57
Rao-Blackwellized Particle Filtering for Probing-Based 6-DOF Localization in	58
Pose Estimation in Heavy Clutter Using a Multi-Flash Camera	58
Needle Picking: A Sampling Based Track-Before-Detection Method For Small Targets ...	59
Coded Strobing Photography: Compressive Sensing of High-Speed Periodic Events.....	59
Scene-Adaptive Human Detection with Incremental Active Learning	60
SKYLINE2GPS: Localization in Urban Canyons Using Omni-skylines.....	60
Analytical Forward Projection for Axial Non-Central Dioptric & Catadioptric Cameras ...	61
Learning on Manifolds.....	61
Axial-Cones: Modeling Spherical Catadioptric Cameras for Wide-Angle Light Field ...	62
P2Pi: A Minimal Solution for registration of 3D Points to 3D Planes	62

Morphable Reflectance Fields for Enhancing Face Recognition

Citation: Kumar, R.; Jones, M.J.; Marks, T.K., "Morphable Reflectance Fields for Enhancing Face Recognition", *IEEE Conference on Computer Vision and Pattern Recognition (CVPR)*, DOI: 10.1109/CVPR.2010.5539972, pp. 2606-2613, June 2010

Contacts: Michael Jones, Tim Marks

In this paper, we present a novel framework to address the confounding effects of illumination variation in face recognition. By augmenting the gallery set with realistically relit images, we enhance recognition performance in a classifier-independent way. We

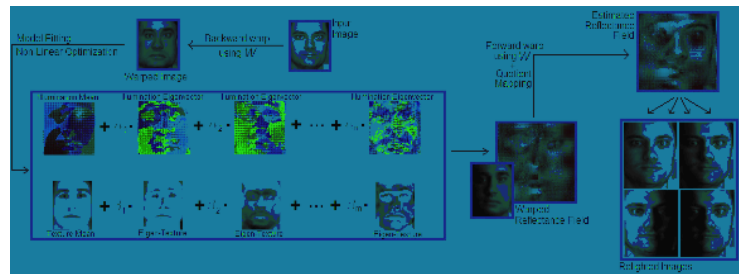

describe a novel method for single-image relighting called Morphable Reflectance Fields (MoRF) that does not require manual intervention and provides relighting superior to that of existing automatic methods. We test our framework through face recognition experiments using various state-of-the-art classifiers and popular benchmark datasets: CMU PIE, Multi-PIE, and MERL Dome. We demonstrate that our MoRF relighting and gallery augmentation framework achieves improvements in terms of both rank-1 recognition rates and ROC curves. We also compare our model with other automatic relighting methods to confirm its advantage.

Fast Directional Chamfer Matching

Citation: Liu, M-Y.; Tuzel, C.O.; Veeraraghavan, A.N.; Chellappa, R., "Fast Directional Chamfer Matching", *IEEE Conference on Computer Vision and Pattern Recognition (CVPR)*, June 2010

Contacts: Oncel Tuzel, Ashok Veeraraghavan

We study the object localization problem in images given a single hand-drawn example or a gallery of shapes as the object model. Although



many shape matching algorithms have been proposed for the problem over the decades, chamfer matching remains to be the preferred method when speed and robustness are considered. In this paper, we significantly improve the accuracy of chamfer matching while reducing the computational time from linear to sublinear (shown empirically). Specifically, we incorporate edge orientation information in the matching algorithm such that the resulting cost function is piecewise smooth and the cost variation is tightly bounded. Moreover, we present a sublinear time algorithm for exact computation of the directional chamfer matching score using techniques from 3D distance transforms and directional integral images. Experiments show that the proposed approach improves the speed of the original chamfer matching up to an order of 45x.

Breaking the Interactive Bottleneck in Multi-Class Classification with Active Selection and Binary Feedback

Citation: Joshi, A.J.; Porikli, F.M.; Papanikolopoulos, N., "Breaking the Interactive Bottleneck in Multi-class Classification with Active Selection and Binary Feedback", *IEEE Conference on Computer Vision and Pattern Recognition (CVPR)*, Object Recognition, June 2010

Contacts: Fatih Porikli

Multi-class classification schemes typically require human input in the form of precise category names or numbers for each example to be annotated. Providing this can be impractical for the user. We propose a multi-class active learning model that requires only binary (yes/no type) feedback from the user. We first show the interactive benefits of such a scheme with experiments. We then propose a Value of Information (VOI)-based active selection algorithm in the binary feedback model. The algorithm iteratively selects image pairs for annotation to maximize accuracy, while also minimizing user annotation effort. To our knowledge, this is the first multi-class active learning approach that requires only yes/no inputs. Experiments show that the proposed method can substantially minimize user supervision compared to the traditional training model on problems with as many as 100 classes.

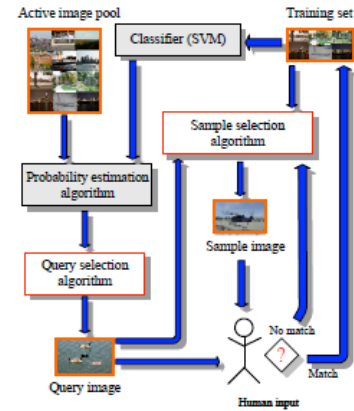

RelCom: Relational Combinatorics Features for Rapid Object Detection

Citation: Venkatraman, V.; Porikli, F.M., "RelCom: Relational Combinatorics Features for Rapid Object Detection", *IEEE Workshop on Object Tracking and Classification Beyond and in the Visible Spectrum*, Robust Object Detection, June 2010

Contacts: Fatih Porikli

We present a simple yet elegant feature, RelCom, and a boosted selection method to achieve a very low complexity object detector. We generate combinations of low-level feature coefficients and apply relational operations such as margin based similarity rule over each possible pair of these combinations to construct a proposition space. From this space we define combinatorial functions of Boolean operators to form complex hypotheses that model any logical proposition. In case these coefficients are associated with the pixel coordinates, they encapsulate higher order spatial structure within the object window. Our results on benchmark datasets prove that the boosted RelCom features can match the performance of HOG features of SVM-RBF while providing 5X speed up and significantly outperform SVM-linear while reducing the false alarm rate 5X~20X. In case of intensity features the improvement in false alarm rate over SVM-RBF is 14X with a 128X speed up.

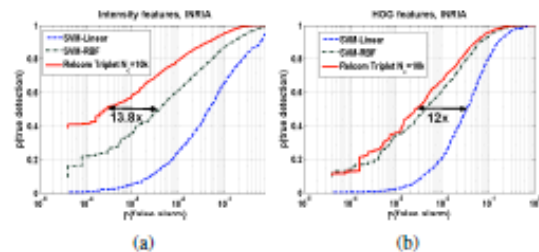

Rao-Blackwellized Particle Filtering for Probing-Based 6-DOF Localization in Robotic Assembly

Citation: Taguchi, Y.; Marks, T.K.; Okuda, H., "Rao-Blackwellized Particle Filtering for Probing-based 6-DOF Localization in Robotic Assembly", *IEEE International Conference on Robotics and Automation (ICRA)*, ISSN: 105-4729, pp. 2610-2617, Best Automation Paper Award Finalist, May 2010

Contacts: Yuchi Taguchi, Tim Marks

This paper presents a probing-based method for probabilistic localization in automated robotic assembly. We consider peg-in-hole problems in which a needle-like peg has a single point of contact with the object that contains the hole, and in which the initial uncertainty in the relative pose (3D position and 3D angle) between the peg and the object is much greater than the required accuracy (assembly clearance). We solve this 6 degree-of-freedom (6-DOF) localization problem using a Rao-Blackwellized particle filter, in which the probability distribution over the peg's pose is factored into two components: The distribution over position (3-DOF) is represented by particles, while the distribution over angle (3-DOF) is approximated as a Gaussian distribution for each particle, updated using an extended Kalman filter. This factorization reduces the number of particles required for localization by orders of magnitude, enabling real-time online 6-DOF pose estimation. Each measurement is simply the contact position obtained by randomly repositioning the peg and moving towards the object until there is contact. To compute the likelihood of each measurement, we use a mesh model of the object that is based on the CAD model but also explicitly models the uncertainty in the map.

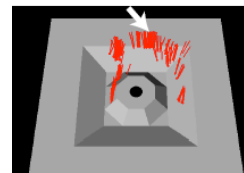

Pose Estimation in Heavy Clutter Using a Multi-Flash Camera

Citation: Liu, M-Y.; Tuzel, C.O.; Veeraraghavan, A.N.; Chellappa, R.; Agrawal, A.K.; Okuda, H., "Pose Estimation in Heavy Clutter Using a Multi-Flash Camera", *IEEE International Conference on Robotics and Automation (ICRA)*, May 2010

Contacts: Oncel Tuzel, Ashok Veeraraghavan

We propose a novel solution to object detection, localization and pose estimation with applications in robot vision. The proposed method is especially applicable when the objects of interest may not be richly textured and are immersed in heavy clutter. We show that a multi-flash camera (MFC) provides accurate separation of depth edges and texture edges in such scenes. Then, we reformulate the problem, as one finding matches between the depth edges obtained in one or more MFC images to the rendered depth edges that are computed offline using 3D CAD models of the objects. We introduce a novel cost function that respects both the position and the local orientation of each edge pixel. This cost function is significantly superior to traditional Chamfer cost and leads to accurate matching even in heavily cluttered scenes where traditional methods are unreliable. We present a sub-linear time algorithm to compute the cost function using techniques from 3D distance transforms and integral images.



Needle Picking: A Sampling Based Track-Before-Detection Method for Small Targets

Citation: Porikli, F.M., "Needle Picking: A Sampling Based Track-before-Detection Method for Small Targets", *SPIE Conference on Signal and Data Processing of Small Targets*, Vol. 7698, 769803 (2010); DOI: 10.1117/12.850452, April 2010
Contacts: Fatih Porikli

We present a computationally efficient track-before-detect algorithm that achieves more than 50% true detection at 0.000001 false alarm rate for unknown numbers of pixel-sized targets when the signal-to-noise ratio is less than 7dB. Without making any assumptions on the distribution functions, we select a small number of cells, so called as needles, and generate motion hypotheses using the target state transition model. We accumulate cell likelihoods along each hypothesis in the temporal window and append the accumulated values to the corresponding queues of the cell position in the most recent image.

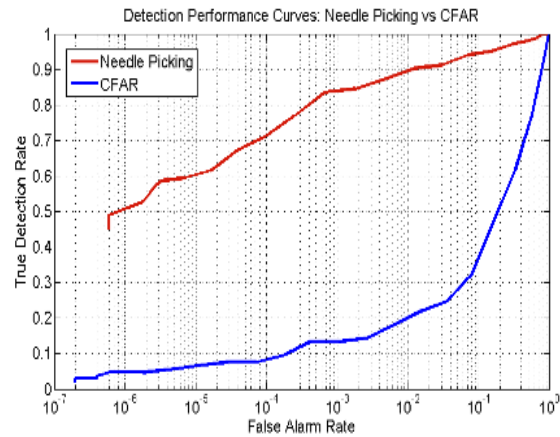

Coded Stroboscopic Photography: Compressive Sensing of High-Speed Periodic Events

Citation: Veeraraghavan, A.N.; Reddy, D.; Raskar, R., "Coded Stroboscopic Photography: Compressive Sensing of High-Speed Periodic Events", *IEEE Transactions on Pattern Analysis and Machine Intelligence*, ISSN: 0163-8828, pp. I-1, April 2010
Contacts: Ashok Veeraraghavan

We show that, via temporal modulation, one can observe a high-speed periodic event well beyond the abilities of a low-frame camera. By strobing the exposure with unique sequences within the integration time of each frame, we take coded projections of dynamic events. From a sequence of such frames, we reconstruct a high-speed video of the high frequency periodic process. Strobing is used in entertainment, medical imaging and industrial inspection to generate lower beat frequencies. But this is limited to scenes with a detectable single dominant frequency and requires high-intensity lighting. In this paper, we address the problem of sub-Nyquist sampling of periodic signals and show designs to capture and reconstruct such signals. The key result is that for such signals the Nyquist rate constraint can be imposed on strobe-rate rather than the sensor-rate. The technique is based on intentional aliasing of the frequency components of the periodic signal while the reconstruction algorithm exploits recent advances in sparse representations and compressive sensing.

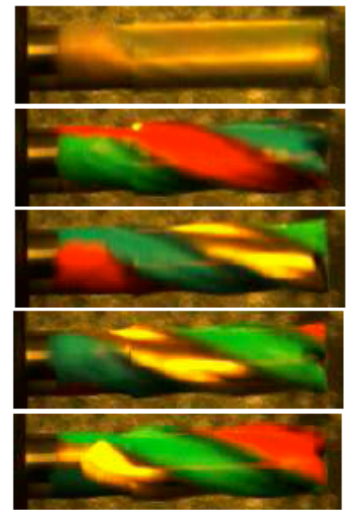

(b) 6000 RPM

Scene-Adaptive Human Detection with Incremental Active Learning

Citation: Joshi, A.J.; Porikli, F., "Scene-Adaptive Human Detection with Incremental Active Learning", *International Conference on Pattern Recognition (ICPR)*, ISBN: 978-0-7695-4109-9, August 2010

Contacts: Fatih Porikli

In many computer vision tasks, scene changes hinder the generalization ability of trained classifiers. For instance, a human detector trained with one set of images is unlikely to perform well in different scene conditions. In this paper, we propose an incremental learning method for human detection that can take generic training data and build a new classifier adapted to the new deployment scene. Two operation modes are proposed: i) a completely autonomous mode wherein first few empty frames of video are used for adaptation, and ii) an active learning approach with user in the loop, for more challenging scenarios including situations where empty initialization frames may not exist. Results show the strength of the proposed methods for quick adaptation.

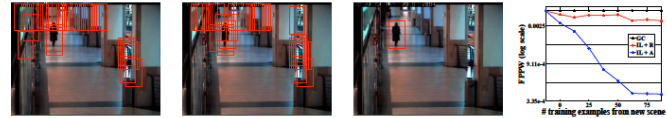

Figure 3. Sample results with 75 training examples from CAVIAR. (a) Generic classifier, (b) Incremental learning with random selection, (c) Incremental learning with active selection. (d) FPPW values of different methods with varying number of training examples on VID.

SKYLINE2GPS: Localization in Urban Canyons Using Omni-skylines

Citation: Ramalingam, S.; Bouaziz, S.; Sturm, P.; Brand, M., "SKYLINE2GPS: Localization in Urban Canyons Using Omni-skylines", *IEEE/RSJ International Conference on Intelligent Robots and Systems (IROS)*, ISSN 2153-0858, pp. 3816-3823, October 2010

Contacts: Srikumar Ramalingam, Matthew Brand

This paper investigates the problem of geolocation in GPS challenged urban canyons using only skylines. Our proposed solution takes a sequence of upward facing omnidirectional images and coarse 3D models of cities to compute the geo-trajectory. The camera is oriented upwards to capture images of the immediate skylines, which is generally unique and serves as a fingerprint for a specific location in a city. Our goal is to estimate global position by matching skylines extracted from omni-directional images to skyline segments from coarse 3D city models. Under day-time and clear sky conditions, we propose a sky-segmentation algorithm using graph cuts for estimating the geo-location. In cases where the skyline gets affected by partial fog, nighttime and occlusions from trees, we propose a shortest path algorithm that computes the location without prior sky detection. We show compelling experimental results for hundreds of images taken in New York, Boston and Tokyo under various weather and lighting conditions (daytime, foggy dawn and night-time).

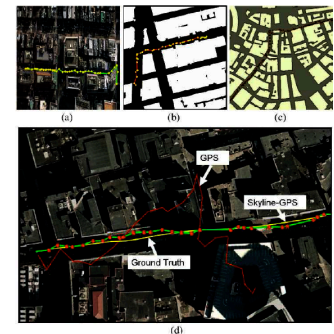

Fig. 10. On the top (a,b and c) we show the geo-trajectories obtained for 100's of images using our algorithm. In (d) we show a comparison with the GPS.

Analytical Forward Projection for Axial Non-Central Dioptric & Catadioptric Cameras

Citation: Agrawal, A.; Taguchi, Y.; Ramalingam, S., "Analytical Forward Projection for Axial Non-Central Dioptric & Catadioptric Cameras", *European Conference on Computer Vision (ECCV)*, September 2010

Contacts: Amit Agrawal, Yuchi Taguchi, Srikumar Ramalingam

We present a technique for modeling non-central catadioptric cameras consisting of a perspective camera and a rotationally symmetric conic reflector. While previous approaches use a central approximation and/or iterative methods for forward projection, we present an analytical solution. This allows computation of the optical path from a given 3D point to the given viewpoint by solving a 6th degree forward projection equation for general conic mirrors. For a spherical mirror, the forward projection reduces to a 4th degree equation, resulting in a closed form solution. We also derive the forward projection equation for imaging through a refractive sphere (non-central dioptric camera) and show that it is a 10th degree equation. While central catadioptric cameras lead to conic epipolar curves, we show the existence of a quartic epipolar curve for catadioptric systems using a spherical mirror. The analytical forward projection leads to accurate and fast 3D reconstruction via bundle adjustment. Simulations and real results on single image sparse 3D reconstruction are presented. We demonstrate ~ 100 times speed up using the analytical solution over iterative forward projection for 3D reconstruction using spherical mirrors.

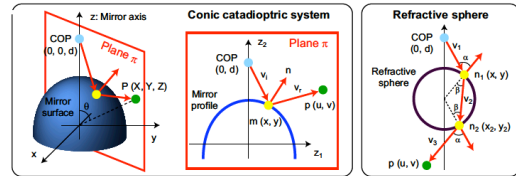

Fig. 1. (Left) Reflection for conic catadioptric systems can be analyzed in the plane π containing the mirror axis and the 3D scene point. (Right) Imaging through a refractive sphere can also be analyzed similarly.

Learning on Manifolds

Citation: Porikli, F., "Learning on Manifolds", *Joint IAPR International Conference on Structural, Syntactic and Statistical Pattern Recognition (SSPR & SPR)*, August 2010

Contacts: Fatih Porikli

Mathematical formulation of certain natural phenomena exhibits group structure on topological spaces that resemble the Euclidean space only on a small enough scale, which prevents incorporation of conventional inference methods that require global vector norms. More specifically in computer vision, such underlying notions emerge in differentiable parameter spaces. Here, two Riemannian manifolds including the set of affine transformations and covariance matrices are elaborated and their favorable applications in distance computation, motion estimation, object detection and recognition problems are demonstrated after reviewing some of the fundamental preliminaries.



Fig. 14. Detection examples using cascade of LogitBoost classifiers on manifold. White dots show all the detection results. Black dots are the modes generated and the ellipses are average detection window sizes. There are extremely few false detections and misses.

Axial-Cones: Modeling Spherical Catadioptric Cameras for Wide-Angle Light Field Rendering

Citation: Taguchi, Y.; Agrawal, A.; Veeraraghavan, A.; Ramalingam, S.; Raskar, R., "Axial-Cones: Modeling Spherical Catadioptric Cameras for Wide-Angle Light Field Rendering: ", *ACM Transactions on Graphics (TOG)*, ISBN: 978-1-4503-0439-9, Vol. 29, Issue 6, December 2010

Contacts: Yuchi Taguchi, Amit Agrawal, Srikumar Ramalingam

Catadioptric imaging systems are commonly used for wide-angle imaging, but lead to multi-perspective images which do not allow algorithms designed for perspective cameras to be used. Efficient use of such systems requires accurate geometric ray modeling as well as fast algorithms. We present accurate geometric modeling of the multi-perspective photo captured with a spherical catadioptric imaging system using axial-cone cameras: multiple perspective cameras lying on an axis each with a different viewpoint and a different cone of rays. This modeling avoids geometric approximations and allows several algorithms developed for perspective cameras to be applied to multi-perspective catadioptric cameras. We present several applications such as spherical distortion correction, digital refocusing for artistic depth of field effects in wide-angle scenes, and wide-angle dense depth estimation. Our GPU implementation using axial-cone modeling achieves up to three orders of magnitude speed up over ray tracing for these applications.

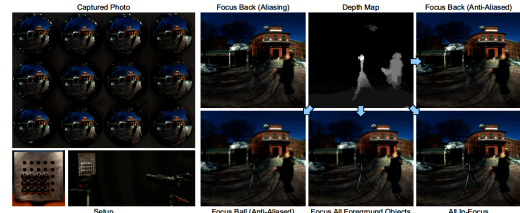

Figure 1: Our axial-cone modeling enables wide-FOV digital refocusing and dense depth estimation using an array of spherical mirrors. We generate $150^\circ \times 150^\circ$ FOV refocused images and a dense depth map on a challenging outdoor scene. The estimated depth map is used for aliasing removal, surface-dependent refocusing, and all-in-focus rendering. The results are depicted using Mercator projection.

P2Pi: A Minimal Solution for registration of 3D Points to 3D Planes

Citation: Ramalingam, S.; Taguchi, Y.; Marks, T.K.; Tuzel, O., "P2Pi: A Minimal Solution for Registration of 3D Points to 3D Planes", *European Conference on Computer Vision (ECCV)*, ISBN: 3-642-15554-5 978-3-642-15554-3, September 2010

Contacts: Srikumar Ramalingam, Yuichi Taguchi, Tim Marks, Oncel Tuzel

This paper presents a class of minimal solutions for the 3D-to-3D registration problem in which the sensor data are 3D points and the corresponding object data are 3D planes. In order to compare the 6 degrees-of-freedom transformation between the sensor and the object, we need at least six points on three or more planes. We systematically investigate and develop pose estimation algorithms for several configurations, including all minimal configurations, which arise from the distribution of points on planes. The degenerate configurations are also identified. We point out that many existing and unsolved 2D-to-3D and 3D-to-3D pose estimation algorithms involving points, lines, and planes can be transformed into the problem of registering points to planes. In addition to simulations, we also demonstrate the algorithm's effectiveness in two real-world applications: registration of a robotic arm with an object using a contact sensor, and registration of 3D point clouds that were obtained using multi-view reconstruction of planar city models.

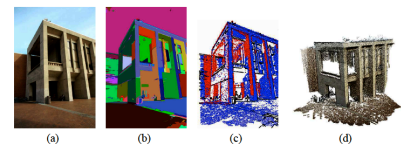

Fig. 7. Registering two point clouds, each generated by applying multi-view reconstruction techniques to 15 images. (a) One of the images used in 3D reconstruction. (b) Superpixel segmentation of the image shown in (a). (c) The 3D points from the first (blue) and second (red) clouds are projected onto the superpixel image. The points from the first point cloud are used to compute the superpixel plane parameters, while the second point cloud is preserved as points. The correspondence between the points from the second cloud and the planes obtained from the first cloud are determined by the underlying superpixel. (d) 3D model after merging the two partial reconstructions from the two clusters. [Best viewed in color]

Mechatronics

The Mechatronics group conducts fundamental and applied research and develops advanced technology in the areas of mechatronic systems and control, merging advanced control theory, dynamical systems theory, physics, computer science, mechanical engineering, optics, embedded systems, and power electronics, all with the intent to expand the performance envelope of Mitsubishi Electric products. The Mechatronics Group has expertise in multivariable, nonlinear, optimal and model-predictive control theory, nonlinear estimation, nonlinear dynamical systems, mechanical design, laser processing and sensing, 3D CAD and rapid prototyping and is growing its research and development portfolio in these areas with an emphasis on control systems and dynamical systems. The business drivers for this R&D program are twofold. First, the design and control of electromechanical systems is central to many areas of Mitsubishi Electric business. Second, with the rapidly increasing power of embedded computation and sensing technologies, there is the opportunity for synergy among research in mechatronics and control and MERL's existing research strengths in computer and information technology.

Recent Research

Modeling Cutting Forces for 5-Axis Machining of Sculptured Surfaces	64
Multiple Time Scaling of a Multi-Output Observer Form	64
Keeping the Good Stuff In: Confidential Information Firewalling with the CRM114	65
Design of Hybrid Resetting PID and Lag Controllers with Application to Motion Control	65

Modeling Current Forces for 5-Axis Machining of Sculptured Surfaces

Citation: Boz, Y.; Erdim, H.; Lazoglu, I., "Modeling Cutting Forces for 5-Axis Machining of Sculptured Surfaces", *International Conference Process Machine Interactions*, Scientific Session C-Metal Cutting Process, June 2010

Contacts: Huseyin Erdim

5-axis milling processes are used widely in various industries such as aerospace, die-mold and biomedical industries where surface quality and integrity is important and the production tolerances are very tight. Therefore, improving surface quality and integrity without sacrificing productivity is crucial in these industries. Improvements in CAD/CAM, cutting tool and the machine tool technologies allow the production of high precision parts in less cycle times.

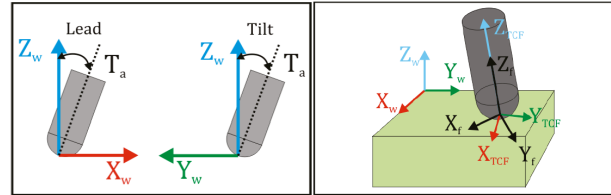

However, desired quality and productivity can be obtained if process parameters such as feedrate, spindle speed, axial and radial depth of cut are selected appropriately. In general, these parameters are selected conservatively based on engineering expertise or trial and error methods in order to prevent work piece, cutter of the machine to be damaged. Therefore, virtual machining simulation for milling processes is an increasing demand before the production of the part. This paper presents a mechanistic cutting force model for 5-axis ball-end milling process simulation. Cutter/work piece engagement is determined via newly developed solid modeler based engagement model. Two different 5-axis machining tests are conducted on A17039 work piece material for the validation of the proposed model. Validation tests demonstrate that presented model is computationally efficient and force predictions are in good agreement with the experimental data.

Multiple Time Scaling of a Multi-Output Observer Form

Citation: Wang, Y.; Lynch A.F., "Multiple Time Scaling of a Multi-Output Observer Form", *IEEE Transactions on Automatic Control*, DOI: 10.1109/TAC.2010.2041616, Vol. 55, Issue 4, pp. 966-971, April 2010

Contacts: Yebin Wang

Time scalings in the multi-output observer form for uncontrolled nonlinear continuous-time systems are considered in this paper. It is the multi-output version of an existing single-input result. Time scaling broadens the class of systems which admits an exact error linearization observer design by including time scaling transformations. The existence conditions of the time scaling transformation and the change of state coordinates to time-scaled observer form are provided.

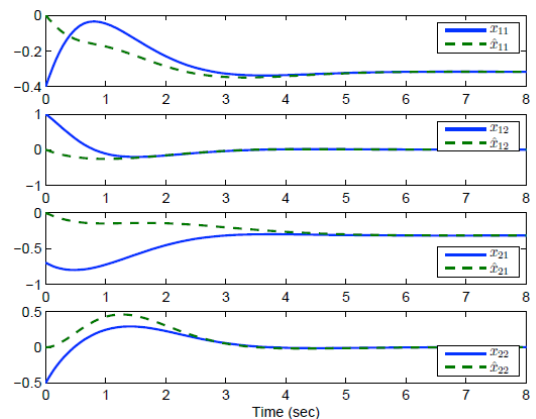

Keeping the Good Stuff In: Confidential Information Firewalling with the CRM114 Spam Filter & Text Classifier

Citation: Yerazunis, W.S.; Kato, M.; Kori, M.; Shibata, H.; Hackenberg, K., “Keeping the Good Stuff In: Confidential Information Firewalling with the CRM114 Spam Filter & Text Classifier”, *Black hat Technical Security Conference*, July 2010
Contacts: William Yerazunis

In this whitepaper we consider the problem of outbound-filtering of emails to prevent accidental leakage of confidential information. We examine how to do this with GPLed open-source spam filter CRM114 and test the accuracy of this filter against a 10,000+ document corpus of hand-classified emails (both confidential and non-confidential) in Japanese. We look into what moving parts are involved in these filters, and how they can be set up. The results show that a hybrid of multiple CRM114 filters outperforms a human-crafted regular-expression filter by nearly 100x in recall, by detecting > 99.9% of confidential documents, and with a simultaneous false alarm rate of less than 6%. As the programmers creating the machine-learning programs don't know how to read or write Japanese, this problem is an almost ideal case of the Searle "Chinese Room" problem.

Design of Hybrid Resetting PID and Lag Controllers with Application to Motion Control

Citation: El-Rifai, K.; El-Rifai, O., “Design of Hybrid Resetting PID and Lag Controllers with Application to Motion Control”, IEEE/ASME International Conference Advanced Intelligent Mechatronics (AIM), DOI: 10.1109/AIM.2009.5229931, July 2009
Contacts: Scott Bortoff

In this paper, new designs for hybrid PID and lag controllers with state resetting are presented. Lyapunov stable designs are shown for first and second order plants, which in case of integral reset for first order plants reduces to that of a Clegg integrator but differs from the First Order Reset Elements (FORE)'s commonly used in the literature for non-integral lag controllers. Furthermore, the proposed PID and lag designs utilize different resetting conditions especially for second order plants, which is an important class of systems for motion control. Different solutions to retain a linear integrator's steady-state disturbance rejection capability are presented. Simulations and experiments for motion control of a typical servo motor driven positioning stage show the performance benefits of these hybrid controllers and verify the analysis.

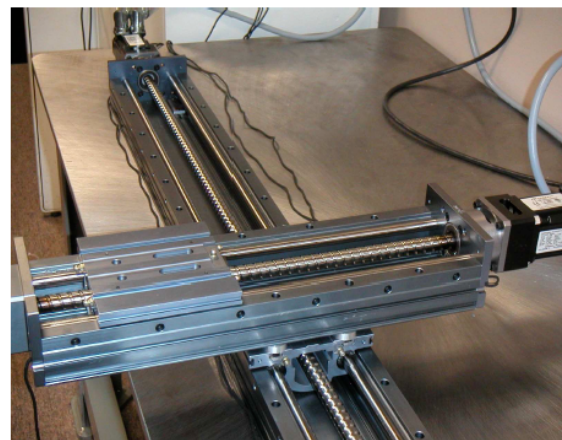

Algorithms

Researchers in the Algorithms group at MERL develop solution methods for optimization problems involving very large numbers of variables. Typically these arise in inference problems involving images, video, or audio; network transport problems; coding and compression problems; or design problems. Usually these problems are characterized by very complicated probability distributions in extremely high dimensional spaces. Because classical approaches to these problems are infeasible, our results can open new business opportunities where there are no competitive technologies. Another main research theme involves adaptively-sampled distance fields, providing superior font and graphical rendering for digital displays.

Most of the group's work revolves around graph-based optimizations and inference, where the graph is a representation of the problem constraints and a probability distribution over possible solutions. Through formal analysis we identify tractable estimation or approximation schemes. This meshes with MERL's expertise in fields and technologies such as belief propagation, machine learning, computer vision, dynamic programming, convex optimization, coding and communications theory, and signal processing.

Recent Research

Divide & Concur and Difference-Map BP Decoders for LDPC Codes	68
Cooperative Routing for Wireless Networks Using Mutual-Information Accumulation	68
Image and Video Retargeting by Darting	69
Adaptively Sampled Distance Fields: A General Representation of Shape	69
Kizamu: A System for Sculpting Digital Characters	70
Designing with Distance Fields	70
Multi-Stage Decoding of LDPC Codes	71
Understanding Belief Propagation and its Generalization.....	71
Stochastic Shortest Paths Via Quasi-convex Maximization.....	72

Divide & Concur and Difference-Map BP Decoders for LDPC Codes

Citation: Yedidia, J.S.; Wang, Y.; Draper, S.C., "Divide & Concur and Difference - Map BP Decoders for LDPC Codes", *Physics of Algorithms*, arXiv:1001.1730, August 2009

Contacts: Jonathan Yedidia, Yige Wang

The "Divide and Concur" (DC) algorithm, recently introduced by Gravel and Elser, can be considered a competitor to the belief propagation (BP) algorithm, in that both algorithms can be applied to a wide variety of constraint satisfaction, optimization, and probabilistic inference problems. We show that DC can be interpreted as a message-passing algorithm on a constraint graph, which helps make the comparison with BP clearer. The "difference-map" dynamics of the DC algorithm enables it to avoid "traps" which may be related to the "trapping sets" or "pseudo-codewords" that plague BP decoders of low-density parity check (LDPC) codes in the error-floor regime. We investigate two decoders for low density parity-check (LDPC) codes based on these ideas. The first decoder is based directly on DC, while the second decoder borrows the important "difference-map" concept from the DC algorithm and translates it into a BP-like decoder. We show that this "difference-map belief propagation" (DMBP) decoder has dramatically improved error-floor performance compared to standard BP decoders, while maintaining a similar computational complexity.

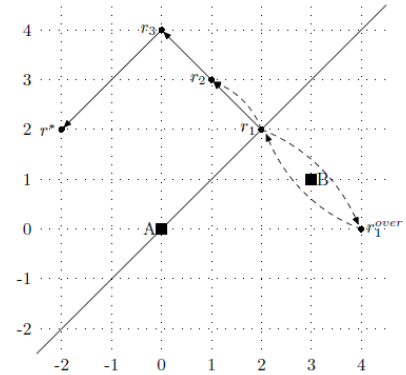

t	r_t	$P_D(r_t)$	r_t^{over}	r_t^{conc}
1	(2, 2)	(3, 1)	(4, 0)	(2, 2)
2	(1, 3)	(3, 1)	(5, -1)	(2, 2)
3	(0, 4)	(0, 0)	(0, -4)	(-2, -2)
4	(-2, 2)	(0, 0)	(2, -2)	(0, 0)
5	(-2, 2)			

Cooperative Routing for Wireless Networks Using Mutual-Information Accumulation

Citation: Draper, S.C.; Liu, L.; Molisch, A.F.; Yedidia, J.S., "Cooperative Routing for Wireless Networks using Mutual-Information Accumulation", *The Smithsonian/NASA Astrophysics Data System*, eprint arXiv:0908.3886, August 2009

Contacts: Jonathan Yedidia

Cooperation between the nodes of wireless multihop networks can increase communication reliability, reduce energy consumption, and decrease latency. The possible improvements are even greater when nodes perform mutual information accumulation using rateless codes. In this paper, we investigate routing problems in such networks. Given a network, a source, and a destination, our objective is to minimize end-to-end transmission delay under energy and bandwidth constraints. We provide an algorithm that determines which nodes should participate in forwarding the message and what resources (time, energy, and bandwidth) should be allocated to each.

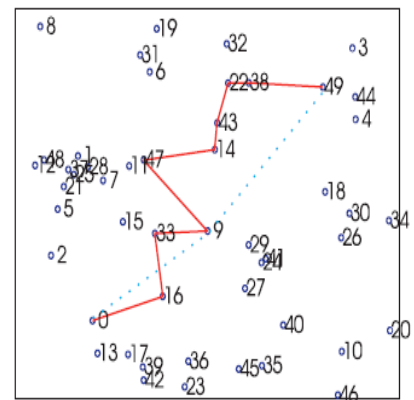

Image and Video Retargeting by Darting

Citation: Brand, M., "Image and Video Retargetting by Darting", *Image Analysis and Recognition*, ISBN: 978 3 642 02610 2, Vol. 5627/2009, pp. 33-42, July 2009

Contact: Matt Brand

We consider the problem of altering an image by imperceptibly adding or removing pixels, for example, to fit a differently shaped frame with minimal loss of interesting content. We show how to construct a family of convex



programs that suitably rearrange pixels while minimizing image artifacts and distortions. We call this “darting” on analogy to a tailor’s darts—small edits are discreetly distributed throughout the fabric of the image. We develop a reduction to integer dynamic programming on edit trellises, yielding fast algorithms. One- and two-pass variants of the method have $O(1)$ per-pixel complexity. Of the many edits that darting supports, five are demonstrated here: image retargeting to smaller aspect ratios; adding or moving or removing scene objects while preserving image dimensions; image expansion with gaps filled by a rudimentary form of texture synthesis; temporal video summarization by “packing” motion in time; and an extension to spatial video retargeting that avoids motion artifacts by preserving optical flow.

Adaptively Sampled Distance Fields: A General Representation of Shape for Computer Graphics

Citation: Frisken, S.F.; Perry, R.N.; Rockwood, A.P.; Jones, T.R., "Adaptively Sampled Distance Fields: A General Representation of Shape for Computer Graphics", *ACM SIGGRAPH*, ISBN: 1-58113-208-5, pps 249-254, July 2000

Contacts: Ronald Perry

Adaptively Sampled Distance Fields (ADFs) are a unifying representation of shape that integrate numerous concepts in computer graphics including the representation of geometry and volume data and a broad range of processing operations such as rendering, sculpting, level-of-detail management, surface offsetting, collision detection, and color gamut correction. Its

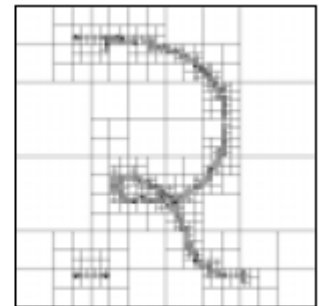
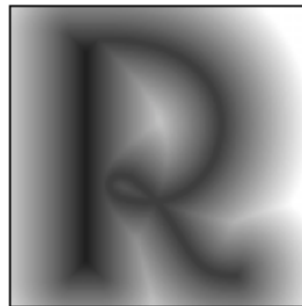

structure is uncomplicated and direct, but is especially effective for quality reconstruction of complex shapes, e.g., artistic and organic forms, precision parts, volumes, high order functions, and fractals. We characterize one implementation of ADFs, illustrating its utility on two diverse applications: 1) artistic carving of fine detail, and 2) representing and rendering volume data and volumetric effects. Other applications are briefly presented.

Kizamu: A System for Sculpting Digital Characters

Citation: Perry, R.N.; Frisken, S.F., "Kizamu: A System for Sculpting Digital Characters", *ACM SIGGRAPH*, ISBN: 1-58113-374-X, pp. 47-56, August 2001

Contacts: Ronald Perry

This paper presents Kizamu, a computer-based sculpting system for creating digital characters for the entertainment industry. Kizamu incorporates a blend of new algorithms, significant technical advances, and novel user interaction paradigms into a system that is both powerful and unique. At the heart of the Kizamu system are Adaptively Sampled Distance Fields (ADFs), a volumetric shape representation with the characteristics required for digital clay. In this paper, we describe the system and present the major research advances in ADFs that were required to make Kizamu a reality.

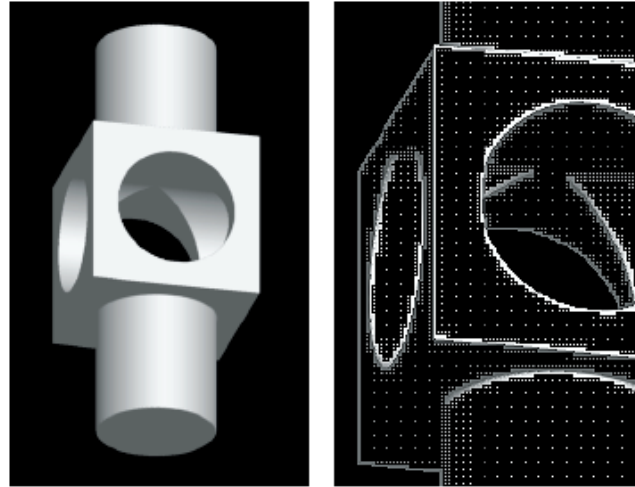

Designing with Distance Fields

Citation: Frisken, S.F.; Perry, R.N., "Designing with Distance Fields", *ACM SIGGRAPH*, ISBN: 1-59593-364-6, pp. 60-66, July 2006

Contacts: Ronald Perry

Distance fields provide an implicit representation of shape that has advantages in many application areas; in this overview, we focus on their use in digital design. Distance fields have been used in Computer Aided Design since the 1970's (e.g. for computing offset surfaces and for generating rounds and filets). More recently, distance fields have been used for freeform design where their dual nature of providing both a volumetric representation and a high-quality surface representation provides a medium that has some of the properties of real clay. Modern computer systems coupled with efficient representations and methods for processing distance fields have made it possible to use distance fields in interactive design systems. This overview reviews previous work in distance fields, discusses the properties and advantages of distance fields that make them suitable for digital design, and describes Adaptively Sampled Distance Fields (ADFs), a distance field representation capable of representing detailed, high quality, and expressive shapes. ADFs are both efficient to process and have a relatively small memory footprint.

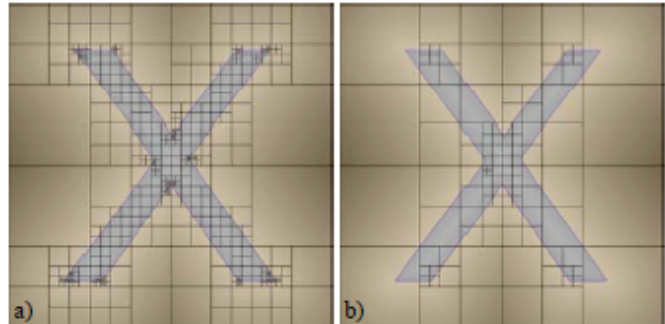

Multi-Stage Decoding of LDPC Codes

Citation: Wang, Y.; Yedidia, J.S.; Draper, S.C., "Multi-Stage Decoding of LCPC Codes", *IEEE International Symposium on Information Theory*, June 2009

Contacts: Yige Wang, Jonathan Yedidia

We present a three-stage decoding strategy that combines quantized and un-quantized belief propagation (BP) decoders with a mixed-integer linear programming (MILP) decoder. Each decoding stage is activated only when the proceeding stage fails to converge to a valid codeword. The faster BP decoding stages are able to correct most errors, yielding a short average decoding time. Only in the rare cases when the iterative stages fail is the slower but more powerful MILP decoder used. The MILP decoder iteratively adds binary constraints until either the maximum likelihood codeword is found or some maximum number of binary constraints has been added. Simulation results demonstrate a large improvement in the word error rate (WER) of the proposed multi-stage decoder in comparison to belief propagation. The improvement is particularly noticeable in the low crossover probability (error floor) regime. We demonstrate that for certain codes our approach can efficiently approach the optimal ML decoding performance for low crossover probabilities.

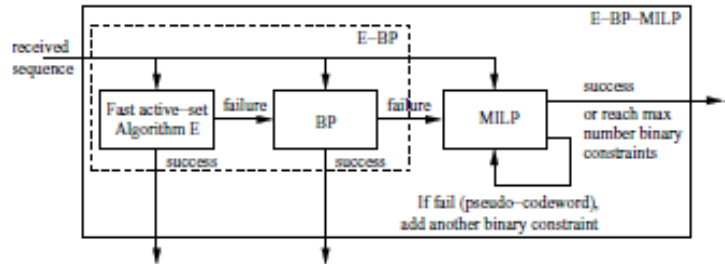

Understanding Belief Propagation and its Generalization

Citation: Yedidia, J.S.; Freeman, W.T.; Weiss, Y., "Understanding Belief Propagation and Its Generalizations", *Exploring Artificial Intelligence in the New Millennium*, ISBN 1558608117, Chap. 8, pp. 239-236, January 2003

Contacts: Jonathan Yedidia

"Inference" problems arise in statistical physics, computer vision, error-correcting coding theory, and AI. We explain the principles behind the belief propagation (BP) algorithm, which is an efficient way to solve inference problems based on passing local messages. We develop a unified approach with examples, notation, and graphical models borrowed from the relevant disciplines. We explain the close connection between the BP algorithm and the Bethe approximation of statistical physics. In particular, we show that BP can only converge to a fixed point that is also a stationary point of the Bethe approximation to the free energy. This result helps explain the successes of the BP algorithm and enables connections to be made with variational approaches to approximate inference.

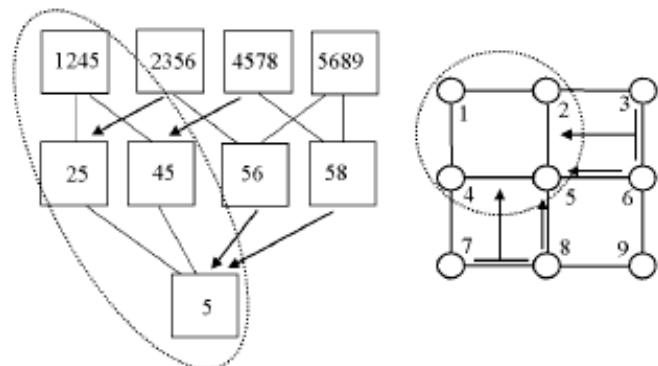

Stochastic Shortest Paths Via Quasi-convex Maximization

Citation: Nikolova, E.; Kelner, J.; Brand, M.; Mitzenmacher, M., "Stochastic Shortest Paths Via Quasi-convex Maximization", *ESA 2006*, ISBN:3-540-38875-3, Pp 552 - 563 , September 2006

Contacts: Matthew Brand

We consider the problem of finding shortest paths in a graph with independent randomly distributed edge lengths. Our goal is to maximize the probability that the path length does not exceed a given threshold value (deadline). We give a surprising exact $n^{\theta(\log n)}$ algorithm for the case of normally distributed edge lengths, which is based on quasi-convex maximization. We then prove average and smoothed polynomial bounds for this algorithm, which also translate to average and smoothed bounds for the parametric shortest path problem, and extend to a more general non-convex optimization setting. We also consider a number of other edge length distributions, giving a range of exact and approximation schemes.

