

Mitsubishi Electric Research Laboratories (MERL)

Annual Report

April 2016 through March 2017

TR2017-00

(Published June 2017)

Welcome to Mitsubishi Electric Research Laboratories (MERL), the North American corporate R&D arm of Mitsubishi Electric Corporation. In this report, you will find descriptions of MERL and our projects.

This work may not be copied or reproduced in whole or in part for any commercial purpose. Permission to copy in whole or in part without payment of fee is granted for nonprofit educational and research purposes provided that all such whole or partial copies include the following: a notice that such copying is by permission of Mitsubishi Electric Research Laboratories; an acknowledgment of the authors and individual contributions to the work; and all applicable portions of the copyright notice. Copying, reproduction, or republishing for another purpose shall require a license with payment of fee to Mitsubishi Electric Research Laboratories. All rights reserved.

Copyright © Mitsubishi Electric Research Laboratories, 2017
201 Broadway, Cambridge, Massachusetts 02139
617.621.7500

Production:

Marissa Deegan, Richard C. Waters

Table of Contents

Mitsubishi Electric Research Laboratories	1
Awards and Commendations	7
Technical Staff	9
Publications	25
Research	43
Electronics & Communications	45
Multimedia	53
Data Analytics	61
Computer Vision	69
Mechatronics	77
Algorithms	85

Mitsubishi Electric Research Laboratories

Mitsubishi Electric Research Laboratories (MERL) is the North American subsidiary of the corporate research and development organization of Mitsubishi Electric Corporation. MERL conducts application-motivated basic research and advanced development in optimization, control and signal processing.

MERL's mission—our assignment from Mitsubishi Electric:

- Generating new technology and intellectual property in areas of importance to Mitsubishi Electric.
- Significantly impacting Mitsubishi Electric's business: using our technical expertise in partnership with organizations in Mitsubishi Electric to produce new and improved products in Mitsubishi Electric's main areas of business.

MERL's vision—our goal for ourselves:

- Being one of the world's premiere research laboratories, doing long-term fundamental research that advances the frontiers of technology and makes lasting impacts on the world.
- Being the prime source of technology for Mitsubishi Electric in our areas of expertise.

MERL's values—how we operate:

- Hiring very high quality researchers and supporting them strongly with a flexible work environment featuring teamwork both inside MERL and with our colleagues at Mitsubishi Electric.
- Participating in the world research community, publishing our work while maintaining the confidentiality of business information, and collaborating with interns and universities.

MERL focuses on five principal technology sectors:

Electronics & Communications - featuring wireless & optical signal processing technology.

Multimedia – featuring speech interfaces, video (de)coding & compressive sensing.

Data Analytics – featuring simulation, planning and optimization.

Computer Vision – featuring 3D imaging processing algorithms.

Mechatronics – featuring advanced control of electro-mechanical systems.

An Algorithms group supports all five sectors, developing fundamental algorithms.

A Business Innovation group focuses on changes in Mitsubishi Electric's approach to business.

This annual report is a snapshot of MERL's web site. For additional and updated information please visit "www.merl.com".

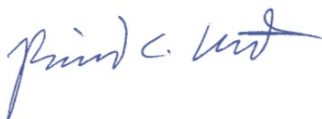

Richard C. Waters
President, MERL

MERL Organization

MERL is organized as seven groups centered on technology areas, which collaborate closely to achieve groundbreaking results. We use a relatively flat organization to enhance the opportunities for collaboration within MERL. The six members of the top management team work closely together, guiding all aspects of MERL’s operation.



Richard C. (Dick) Waters *Ph.D., MIT, 1978*
President, CEO & MERL Fellow, ACM Distinguished Scientist

Dick Waters received his Ph.D. in artificial intelligence (AI). For 13 years he worked at the MIT AI Lab as a Research Scientist and co-principal investigator of the Programmer’s Apprentice project. Dick was a founding member of MERL’s Research Lab in 1991. At MERL, his research centered on multi-user interactive environments for work, learning, and play. In 1999, he became CEO of MERL as a whole.



Takuji Magara *Ph.D., Tokyo Institute of Technology, 1992*
Executive Vice President & CFO

Takuji Magara joined Mitsubishi Electric’s Nagoya Works in 1982 where he developed Electric Discharge Machine (EDM) systems, eventually becoming the Senior Manager of EDM Systems Department. In 2008, he then moved to the Advanced Technology Research Center (ATC) as Senior Manager of the Laser and Electric Machining Department. He rose to General Manager of the Electro-Mechanical Technology Laboratory at ATC, before coming to MERL in 2015.



Joseph Katz *Ph.D., California Institute of Technology, 1981*
Vice President & Director, IEEE Fellow, OSA Fellow

After leading research in optical communications and optoelectronic devices & materials at Caltech's Jet Propulsion Laboratory for a number of years, Joseph went to Symbol Technologies, where as Senior VP of R&D he participated in, initiated, and led projects in a wide range of technologies, including barcode/RFID data capture, optics, imaging, signal processing, computing, networking, security, biometrics, and communications. He joined MERL's management in 2004.



Jinyun Zhang *Ph.D., University of Ottawa, 1991*
Vice President, Director & MERL Fellow, IEEE Fellow

Before joining MERL in 2001, Jinyun worked for Nortel Networks for 10 years where she held engineering and management positions in the areas of VLSI design and advanced wireless & optical technology development. She joined MERL's management in 2001. In recognition of her contributions to broadband wireless transmission and networking technology she became an IEEE Fellow in 2008.



Anthony Vetro *Ph.D., Polytechnic University, 2001*
Deputy Director IP & Multimedia Group Manager, IEEE Fellow

Anthony joined MERL in 1996 and has been conducting research in the area of multimedia signal processing. He has contributed to the transfer and development of several technologies to digital television, surveillance, automotive, and satellite imaging systems. He has been an active participant in video coding standards and currently serves as Head of the US Delegation to MPEG. He joined MERL top management in 2014.



Elizabeth Phillips *B.A., University of Massachusetts Amherst, 1988*
Manager, Human Resources & Administration

Elizabeth has over 25 years of human resources experience. For 12 years before joining MERL in 2014 she was the principal of a boutique human resources consulting firm in New England, which supported small to mid-size companies with all aspects of their employee related needs. Engagements included: on-site HR leadership, development of talent management programs, management of total rewards programs, facilitation of employee development programs, and HR compliance and administration.

Mitsubishi Electric

One of the world’s largest companies, Mitsubishi Electric Corporation has \$38 billion in annual sales, \$2.4 billion in operating profits (in the year ending in March 2017) and more than 130,000 employees around the world (see www.mitsubishielectric.com).

Mitsubishi Electric is composed of a wide range of operations. The primary business units are listed below.

Mitsubishi Electric Corp.
Information Systems & Network Services IT Systems, Information Security/Encryption Systems, Business Solutions
Public Utility Systems Government Systems, Transportation Systems, Very Large Display Devices
Energy & Industrial Systems Electrical Generators, Power Transmission and Distribution Equipment
Building Systems Elevators, Escalators, Building Monitoring/Security/Management Systems
Electronic Systems Satellites, Radar Systems, Antennas, Electronic Toll Collection Systems
Communication Systems Wired & Wireless Communication, Broadcasting Equipment and Systems
Living Environment & Digital Media Equipment Televisions, Blu-ray Recorders, Air Conditioners, Solar Power Systems
Factory Automation Systems Programmable Logic Controllers, Inverters, Servo-motors, Processing Machines
Automotive Equipment Automotive Electrical Equipment, Car Electronics/Multimedia, Car Mechatronics
Semiconductor & Device Optical Devices, High-Frequency & High-Power Semiconductors

Together, these ten business units produce most of Mitsubishi Electric’s revenue. Due to the wide applicability of MERL’s research, MERL works with them all.

It is worthy of note that there are over 30 major independent companies in the world that use the word “Mitsubishi” in their names. These companies include Mitsubishi UFJ Financial Group, Mitsubishi Corporation, Mitsubishi Heavy Industries, Mitsubishi Chemical Holdings and Mitsubishi Motors, all of which are also among the world’s largest companies. They have shared roots in 19th century Japan; however, they have been separate for many years and Mitsubishi Electric has been separate from all of them since it was founded in 1921.

Mitsubishi Electric’s US Operations

A significant part of Mitsubishi Electric’s sales are in North America and many of Mitsubishi Electric’s business units have North American subsidiaries. The largest US operations are listed below (see www.mitsubishielectric-usa.com).

<p>Mitsubishi Electric Automotive America, Inc. (Detroit MI & Mason OH) Alternators, Ignition Coils, Automotive Electronics</p>
<p>Mitsubishi Electric Power Products, Inc. (Pittsburgh PA & Memphis TN) Power Transmission Products, Rail Transportation Systems</p>
<p>Mitsubishi Electric USA, Inc. (Los Angeles CA & other cities) Air Conditioners, Elevators, Photovoltaic Panels, High Power Semiconductors</p>
<p>Mitsubishi Electric Automation, Inc. (Chicago IL) Factory Automation Equipment</p>

Mitsubishi Electric Corporate R&D

Mitsubishi Electric has a global R&D network comprising five laboratories. The chart below summarizes the primary activities of these labs. MERL collaborates with all of these labs.

Corporate R&D Headquarters (Tokyo)	
	<p>Advanced Technology R&D Center (Amagasaki & Nagaokakyo, in greater Osaka) Power Electronics, Electro-mechanical, Ecology, Energy, Materials, Devices, Systems and Imaging Technologies</p>
	<p>Information Technology R&D Center (Ofuna, in greater Tokyo) Information, Communications, Multimedia, Electro-Optic and Microwave Technologies</p>
	<p>Industrial Design Center (Ofuna, in greater Tokyo) Product, Interface and Concept Design</p>
	<p>Mitsubishi Electric Research Laboratories, Inc. (Cambridge MA) Communications, Multimedia, Data Analytics, Imaging and Mechatronics Technologies</p>
	<p>Mitsubishi Electric R&D Centre Europe, B.V. (Rennes, France & Edinburgh, Scotland) Communications, Energy & Environmental Technologies</p>
	<p>Mitsubishi Electric (China) Co, Ltd. (Shanghai, China) Materials Science</p>

Awards and Commendations

The high caliber of MERL's research and researchers is evident in a variety of ways. Two are highlighted below. The first is the members of our staff who are Fellows of technical societies. The second is best paper and other awards received from outside organizations. Listed below are awards for the period of this Annual Report.

Current Technical Society Fellows

Dr. Joseph Katz - Fellow, Institute of Electrical and Electronic Engineers
Dr. Joseph Katz - Fellow, Optical Society of America
Dr. Andrew Knyazev - Fellow, Society for Industrial and Applied Mathematics
Dr. Keisuke Kojima - Fellow, Optical Society of America
Dr. Huifang Sun - Fellow, Institute of Electrical and Electronic Engineers
Dr. Anthony Vetro - Fellow, Institute of Electrical and Electronic Engineers
Dr. Jin Zhang - Fellow, Institute of Electrical and Electronic Engineers

Awards and Major Events

MERL's speech researchers scored well in a number of competitions, including being world's best in the MIREX 2016 Singing Voice Separation Task, August 2016.

It is worthy of note that MERL had a large number of papers in some of the most selective and prestigious conferences related to MERL's areas of research: 17 in the American Control Conference (ACC), 10 in the International Conference on Acoustics, Speech, and Signal Processing (ICASSP) and 5 in the Optical Fiber Communication (OFC) Conference. These results make MERL one of the most highly represented research labs in the world at these conferences, with output greater than labs that are much larger.

Technical Staff

By providing a highly productive, collaborative environment, MERL believes that it is more than the sum of its parts; however, there is no question that its only important parts are its people. The following pages present the capabilities and interests of MERL's technical staff members as of the end of the period of this report. Additional information about their work can be found in the publications list and the project descriptions later in this report.



Luigi (Lou) Baccari *B.S., University of Massachusetts of Lowell*
Manager Computational & Network Services & Purchasing

Lou has 23 years of experience in the System and Network Administrations field. For the 6 years prior to joining MERL he worked at HP/Compaq's Cambridge Research Labs providing System and Network. Previous to that he worked for Force Computers, Lycos and Digital Equipment Corp. as Data Center Manager and in various System/Network Support roles.



Mouhacine Benosman *Ph.D., Ecole Centrale de Nantes, 2002*
Senior Principal Research Scientist

Before coming to MERL in 2010, Mouhacine worked at universities in Rome, Italy, Reims, France and Glasgow, Scotland before spending 5 years as a Research Scientist with the Temasek Laboratories at the National University of Singapore. His research interests include modeling and control of flexible systems, non-linear robust and fault tolerant control, vibration suppression in industrial machines and multi-agent control with applications to smart-grid.



Karl Berntorp *Ph.D., Lund University, 2014*
Research Scientist

Karl's doctoral research addressed development of particle-filtering methods, and sensor fusion and optimal control applied to vehicles and robots. His research interests are in nonlinear estimation and control, path planning, motion control, and their applications to automotive, robotics, and aerospace systems.



Scott A. Bortoff *Ph.D., University of Illinois Urbana-Champaign, 1992*
Strategic Project Leader, Distinguished Research Scientist

Scott's research interests are in applications of nonlinear and optimal control theory to motion control, path planning and process control problems. Before joining MERL in 2009, Scott led the Controls Group at the United Technology Research Center and previously was an Associate Professor at the University of Toronto.



Petros T. Boufounos *Sc.D., Massachusetts Institute of Technology, 2006*
Senior Principal Research Scientist, Team Leader

After completing his doctoral studies, Petros joined Rice University as a Postdoctoral associate until Jan. 2009, when he joined MERL. Since joining MERL, Petros has contributed in areas such as high-speed video acquisition, ultrasonic imaging, and privacy-preserving secure embeddings. His interests include signal acquisition and processing, signal representations and compressive sensing. He is also a visiting scholar at Rice University and an Associate Editor of IEEE Signal Processing Letters.



Matthew E. Brand *Ph.D., Northwestern University, 1994*
MERL Fellow

Matt develops and analyzes optimization algorithms for problems in logistics, control, perception, data-mining, and learning. Notable results include methods for parallel solution of quadratic programs, recomposing photos by re-arranging pixels, nonlinear dimensionality reduction, online singular value decomposition, 3D shape-from-video, and learning concise models of data.



Daniel J. Burns *Ph.D., Massachusetts Institute of Technology, 2010*
Principal Research Scientist

At MIT, Dan developed mechanical designs and controllers for atomic force microscopes that image nano-scale features 1,000 times faster than commercially available instruments. Previously, Dan worked at the Commercial Aviation Systems division of Honeywell, and NASA's Goddard Space Flight Center. Currently, Dan works on control systems design and multi-physical modeling.



Esra Cansizoglu *Ph.D., Northeastern University, 2015*
Research Scientist

Prior to joining MERL, Esra worked on biomedical image processing and machine learning at the Cognitive Systems Laboratory, Northeastern University. Her dissertation was about retinal vasculature extraction, disease classification and analysis of inter-expert variability. Her current research interests include 3D reconstruction and multi-view geometry.



Robert A. Cohen *Ph.D., Rensselaer Polytechnic Institute, 2007*
Principal Research Scientist

Prior to getting his Ph.D., Bob worked for 11 years at Philips Research Labs in NY on HDTV, scalable video streaming, video surveillance, and VLSI rapid prototyping. His current research interests are video coding & communications, and video, image & signal processing. He is an active participant in video coding standards.



Claus Danielson *Ph.D., University of California, Berkeley, 2008*
Research Scientist

Claus' research interests are in model predictive control, constrained control, and networked control systems. His doctoral research was focused on exploiting symmetry in large-scale control and optimization problems.



Marissa Deegan *B.A., Saint Michael's College, 2009*
Lab Administrator

Marissa joined MERL in 2015. She has experience in various fields as coordinators of customer service and administration departments. Previously, she worked as a Coordinator of Customer Service and Administration in a soccer company for children. Her interests are in HR and she is currently pursuing her MBA.



Stefano Di Cairano *Ph.D., University of Siena, 2008*
Senior Principal Research Scientist,
Optimization-Based Control Team Leader

Stefano's interests are model predictive control, constrained control, networked control systems, optimization algorithms, stochastic systems, and their applications to automotive, aerospace, logistics, and factory automation. Stefano is a member of the IEEE CSS Conference Editorial Board, and the Chair of the IEEE CSS Technical Committee on Automotive Controls.



Musau Dibinga *M.B.A., Boston University*
HR Generalist/ Administrator

Prior to joining MERL in 2012, Musau worked as an Accounts Payable Manager at the largest non-profit urban-housing developer in the country and held various managerial positions in operations at an investment management firm in Boston. She currently volunteers as the Managing Director and a Dance Instructor at the Origination Cultural Arts Center, a non-profit performing arts and education program for youth from 3 to 18.



Amir-Massoud Farahmand *Ph.D., University of Alberta, 2011*
Principal Research Scientist

Amir-Massoud's research interests are in reinforcement learning, sequential decision-making under uncertainty, and nonparametric methods in machine learning and statistics. His focus at MERL is on developing theoretically-sound algorithms for challenging industrial problems. Before joining MERL in 2014, he held postdoctoral fellowships at Carnegie Mellon and McGill.



Chen Feng *Ph.D., University of Michigan, 2015*
Research Scientist

Chen worked on computer vision and robotics for construction automation during his Ph.D. research, including camera pose estimation and 3D scene understanding. At MERL, he has worked on SLAM using points and planes, and invented a fast plane extraction algorithm. His research interests include computer vision, photogrammetry, robotics, machine learning, and augmented reality.



Guy Gold
Systems & Network Administrator

Guy Has 12 years of experience with Computing and Networking systems, with special interest in Unix/Linux systems. Previous to working at MERL, Guy worked as a Web Farm admin at Sutra Inc (Airline ticketing systems), as an IT consultant, as Network operations tech at Presbyterian Healthcare services (NM), and for Bezeq's (Israel) core Business IP/VPN support center.



Abraham M. Goldsmith *M.S., Worcester Polytechnic Institute, 2008*
Research Scientist

At WPI, Abraham researched 3D ultrasound imaging, particularly the reconstruction of 3D volumes from sequences of 2D images. At MERL he has worked in areas ranging from wireless sensor networks to optical metrology and control of electro-mechanical systems. In addition to his research responsibilities, Abraham provides electrical and mechanical engineering support to the entire laboratory.



Piyush Grover *Ph.D., Virginia Polytechnic Institute & State Univ., 2010*
Principal Research Scientist

Piyush works at the intersection of dynamical systems, mechanics and control. He is interested in applying geometric and statistical methods for exploiting structure in nonlinear dynamical systems. Areas of applications include low-fuel space mission design, chaotic mixing, model reduction of distributed systems and nonlinear estimation.



Jianlin Guo *Ph.D., University of Windsor, 1995*
Senior Principal Research Scientist

Jianlin worked at Waterloo Maple as a software developer before joining MERL in 1998. His primary research interests include reliable wireless networks, SmartGrid systems, vehicular communications, broadband wireless communications, and embedded systems.



Bret A. Harsham *B.S., Massachusetts Institute of Technology*
Principal Research Scientist

Before joining MERL in 2001, Bret worked at Dragon Systems on handheld and automotive speech products. At MERL, he works on research projects in the area of speech and multimodal applications, with a focus on effectiveness and usability. Past research projects have included work on multi-user touch interfaces and the safety & usability of in-car speech applications.



John R. Hershey *Ph.D., University of California San Diego, 2004*
Senior Principal Research Scientist & Senior Speech and Audio Team Leader

Before coming to MERL in 2010, Hershey was a researcher at IBM's Watson Research Center in New York, in the Speech Algorithms and Engines group, where he was team leader of the Noise Robustness project. He is now working on machine learning for signal enhancement and separation, speech recognition, language processing, and adaptive user interfaces.



Chiori Hori *Ph.D., Tokyo Institute of Technology, 2002*
Visiting Research Scientist

Prior to joining MERL in 2015, Chiori spent 8 years at Japan's National Institute of Information and Communication Technology (NICT). Prior to that, she researched at Carnegie Mellon and the NTT Communication Science Laboratories. She was the research manager of Spoken Language Communication Laboratory of NICT from 2012. Chiori's work has focused on speech summarization/translation, spoken dialog technologies, and standardization of communication protocols for speech interfaces at ITU-T and ASTAP.



Takaaki Hori *Ph.D., Yamagata University, 1999*
Principal Research Scientist

Before joining MERL in 2015, Takaaki spent 15 years doing research on speech and language technology at Nippon Telegraph, and Telephone (NTT) in Japan. His work includes studies on speech recognition algorithms using weighted finite-state transducers (WFSTs), efficient search algorithms for spoken document retrieval, spoken language understanding, and automatic meeting analysis.



Frederick J. Igo, Jr. *B.A., Le Moyne College, 1982*
Senior Principal Member Research Staff

Fred's professional interests are in software development and its process. He joined MERL in 1985 and has worked on various software technologies, including Distributed Computing, Distributed OLTP, Message Queuing, Mobile Agents, Data Mining, ZigBee, reliable wireless protocols and web development. Prior to joining MERL Fred worked at IPL Systems.



Devesh Jha *Ph.D., Pennsylvania State University, 2016*
Visiting Research Scientist

Devesh's PhD Thesis was on decision & control of autonomous systems. He also got a Master's degree in Mathematics from Penn State. His research interests are in the areas of Machine Learning, Time Series Analytics and Robotics. He was a recipient of the best student paper award at the 1st ACM SIGKDD workshop on Machine Learning for Prognostics and Health Management at KDD 2016, San Francisco.



Michael J. Jones *Ph.D., Massachusetts Institute of Technology, 1997*
Senior Principal Research Scientist

Mike's main interest is in computer vision, machine learning and data mining. He has focused on algorithms for detecting and analyzing people in images and video including face detection/recognition and pedestrian detection. He is co-inventor of the popular Viola-Jones face detection method. Mike received the Marr Prize at ICCV and the Longuet-Higgins Prize at CVPR.



Uros Kalabic *Ph.D., University of Michigan, 2015*
Research Scientist

Uros works on advancements in the theory of predictive control and constrained control, as well as its applications to the control of automotive and aerospace systems. His dissertation dealt with theoretical developments and practical applications of reference governors. Prior to joining MERL, Uros interned at MERL and at Ford Motor Company.



Ulugbek Kamilov *Ph.D., Ecole Polytechnique Federale de Lausanne, 2015*
Research Scientist

Ulugbek's PhD research developed statistical estimation techniques for solving inverse problems in biomicroscopy. His interests include signal acquisition and processing, signal representations and resolution of inverse problems. Prior to joining to MERL, Ulugbek was an exchange student at Carnegie Mellon University in 2007, a visiting student at MIT in 2010, and a visiting student researcher at Stanford University.



Kyeong Jin Kim *Ph.D., University of California Santa Barbara, 2000*
Senior Principal Research Scientist

Kyeong Jin's research interests include transceiver design, performance analysis of spectrum sharing systems, design of cooperative communication systems. Since joining MERL, he has contributed in areas such as reliable communications and E-WLAN system. Currently he is an Associate Editor of IEEE Communications Letters.



Andrew Knyazev *Ph.D., Inst of Numerical Math, Soviet Acad of Sci, 1985*
Distinguished Research Scientist, Professor Emeritus University of Colorado
Denver, Society for Industrial and Applied Mathematics (SIAM) Fellow

During his 30 years in the academy, Andrew contributed to numerical analysis of partial differential equations and computational linear algebra, with emphasis on eigenvalue problems. His focus at MERL is on novel algorithms for image & video processing, data sciences, optimal control, material sciences, and numerical simulation of complex phenomena.



Toshiaki Koike-Akino *Ph.D., Kyoto University, 2005*
Senior Principal Research Scientist

Prior to joining MERL in 2010, Toshiaki was a postdoctoral researcher at Harvard University. His research interests include signal processing, cooperative communications, coding theory, and information theory. He received best paper awards at IEEE GLOBECOM in 2008 and 2009.



Keisuke Kojima *Ph.D., University of Tokyo, 1990*
Senior Principal Research Scientist

During his 8 years at the Central Research Laboratory, Mitsubishi Electric Corp. (Amagasaki, Japan), and 13 years AT&T/Lucent Bell Laboratories and other major US companies, Keisuke worked on R&D of semiconductor lasers and optical systems as a technical staff and later as a manager. At MERL he is currently working on simulations of optical devices and systems. He has more than 100 publications in journals and conference proceedings.



Emil Laftchiev *Ph.D., Pennsylvania State University, 2015*
Research Scientist

Emil's research interests are in the identification of efficient storage methods using dimension reducing data features. The purpose of this research is to enable rapid continuous localization within the data. Prior to joining MERL Emil served as a Distinguished Teaching Fellow for the College of Engineering at the Pennsylvania State University.



Christopher Laughman *Ph.D., Massachusetts Institute Technology, 2008*
Senior Principal Research Scientist

Christopher's interests lie in the intersection of the modeling of physical systems and the experimental construction and testing of these systems, including simulation, numerical methods, and fault detection. He has worked on a variety of multi-physical systems, such as thermo-fluid systems and electromechanical energy conversion systems.



Jonathan Le Roux *Ph.D., University of Tokyo, 2009*
Principal Research Scientist

Jonathan completed his B.Sc. and M.Sc. in Mathematics at the Ecole Normale Supérieure in Paris, France. Before joining MERL in 2011, he spent several years in Beijing and Tokyo. In Tokyo he worked as a postdoctoral researcher at NTT's Communication Science Laboratories. His research interests are in signal processing and machine learning applied to speech and audio.



Teng-Yok Lee *Ph.D., Ohio State University, 2011*
Research Scientist

Teng-Yok's research interests cover 2 aspects: Visual (computer graphics, visualization, and image processing) and Computing (GPGPU, high performance and cloud computing). Before joining MERL in 2015, he worked at Amazon Web Service (AWS) to optimize HPC applications on AWS cloud computing environments. His PhD studies were about the visualization of scientific simulation result, especially time-varying and Computational Fluid Dynamics (CFD) data.



Chungwei Lin *Ph.D., Columbia University, 2008*
Visiting Research Scientist

Before joining MERL as a visiting member research staff, Chungwei was a postdoctoral researcher in the Physics Department of the University of Texas at Austin. He has worked on transition metal oxides including manganites and titanates. His particular interest is the use of doping/interface to control optical, thermal, and transport properties. In addition to oxides, he has worked on the theory of self-assembly, configuration interaction quantum impurity solvers, and the theory of photoemission spectroscopy.



Dehong Liu *Ph.D., Tsinghua University, 2002*
Senior Principal Research Scientist

Prior to joining MERL in 2010, Dehong worked at Duke University as a post-doctoral Research Associate (2003-2008), Research Scientist (2008-2010) and Sr. Research Scientist (2010). His main research interests include compressive sensing, signal processing and machine learning.



Rui Ma *Ph.D., University of Kassel, 2009*
Principal Research Scientist

Prior to joining MERL, Rui was a Senior Power Amplifier Research Engineer at Nokia Siemens Networks. His research interests include RF Power Device Modeling, Power Amplifier / Radio Front-End Architectures, non-linear microwave circuit design and high frequency measurement techniques.



Hassan Mansour, *Ph.D. University of British Columbia, 2009*
Principal Research Scientist

Hassan's research interests are in the areas of video compression, video transmission and compressed sensing. His PhD research developed resource allocation schemes for the transmission of scalable video content over bandwidth constrained wireless networks. His postdoctoral work developed adaptive sparse recovery algorithms for correlated signals from compressive measurements.



Tim K. Marks *Ph.D., University of California San Diego, 2006*
Principal Research Scientist

Prior to joining MERL's Imaging Group in 2008, Tim did postdoctoral research in robotic Simultaneous Localization and Mapping in collaboration with NASA's Jet Propulsion Laboratory. His research at MERL spans a variety of areas in computer vision and machine learning, including face recognition under variations in pose and lighting, and robotic vision and touch-based registration for industrial automation.



James McAleenan *J.D., Hamline University Law School, 1999*
Patent Counsel

Jim is a registered patent attorney and former U.S. Patent Examiner with more than 16 years of experience in patent and Intellectual Property law. Jim has held in-house legal roles at significant U.S. and multinational companies, having served as Senior Patent Counsel and Senior Intellectual Property Attorney.



Kathleen McCarthy *B.A., Boston College, 1992*
Controller

Kathleen has worked for over 30 years in the Accounting field with experience in general accounting, payroll and property management. Prior to joining MERL in 1993, she worked in manufacturing, financial and service industries.



David S. Millar *Ph.D., University College London (UCL), 2011*
Principal Research Scientist

Before joining MERL, David was a postdoctoral researcher at UCL, working on DSPs for coherent optical fiber transmission. Since then, he has been working on next generation systems and subsystems for the physical layer. He is particularly interested in advanced modulation formats, algorithms for equalization & carrier recovery, and reduced complexity transponders.



Francis Morales *B.S., Universidad APEC, 2007*
Systems & Network Administrator

Francis has been in the IT field since 2001 with experience in different IT industries with special interest in OSs, Networking and Security. Prior to joining MERL he worked 4 years in the healthcare IT field. Previous to that, he was the principal of a small Computer Service business in his home country.



Saleh Nabi *Ph.D., University of Alberta, 2014*
Visiting Member Research Staff

Saleh's research interests are analytical, numerical and similitude experimental modeling of fluid flow and heat transfer in complex systems. His ambition is to derive reduced order models for turbulent buoyancy-driven flows in confined regions to reduce the simulation run time by several orders of magnitude. Saleh's doctoral research mainly focused on environmental and architectural fluid mechanics applied to airflow modeling within the built environment with applications of novel and advanced HVAC systems.



Daniel N. Nikovski *Ph.D., Carnegie Mellon University, 2002*
Data Analytics Group Manager

Dan's research is focused on algorithms for reasoning, planning, and learning with probabilistic models. His current work is on the application of such algorithms to hard transportation problems such as group elevator control and traffic prediction. He also has varied interests in the field of data mining.



Philip V. Orlik *Ph.D., State University of New York at Stony Brook, 1999*
Electronics & Communications Group Manager

Prior to joining MERL in 2000, Phil worked as a simulation engineer for the MITRE Corporation. His current research interests include wireless communications and networking, signal processing for communication systems, queuing theory, and analytical modeling.



Milutin Pajovic *Ph.D., Massachusetts Institute of Technology, 2014*
Research Scientist

Milutin's doctoral thesis studied adaptive signal processing with deficient sample support using random matrix theory methods and considered adaptive sensor array processing, channel estimation and channel equalization as specific applications. His interests also include communications, statistical signal processing and machine learning.



Kieran Parsons *Ph.D., University of Bristol, UK, 1996*
Senior Principal Research Scientist, Optical Team Leader

Kieran spent 12 years in Canada working at Nortel, BelAir Networks and AMCC on the system design of several wireless and optical technologies, including early work on electronic dispersion compensation for optical links. His research interests include optical communications network architecture and digital signal processing algorithms for coherent optical communications.



Ronald N. Perry *B.Sc., Bucknell University, 1981*
Distinguished Research Scientist

Ron's fundamental research in computer graphics has resulted in numerous publications, a comprehensive patent portfolio, and the development of several meticulously crafted software and hardware products. Ron is best known for the Saffron Type System. The other highlight of his research is the development of 3D ADFs for CAD related products, including an NC simulation system demonstrating unprecedented precision and compactness.



Kristin Peterson *B.S., Towson University, 2007*
Patent Administrator

Kristin joined MERL in 2012 as a Patent assistant. Prior to working at MERL she attended Boston University's Paralegal program to support a career change. She previously held a position in hospital finance and was a Realtor in the Maryland metropolitan area. She has a Bachelor of Science degree in Psychology.



Hongtao Qiao *Ph.D., University of Maryland, 2014*
Research Scientist

Prior to his PhD, Hongtao worked at Carrier Corporation developing advanced steady-state computer simulations for HVAC systems. During his PhD, he developed a comprehensive transient modeling framework for thermo-fluid systems to explore complex dynamic characteristics of vapor compression cycles.



Rien Quirynen *Ph.D., KU Leuven and University of Freiburg, 2017*
Visiting Research Scientist

Rien's research interests are in model predictive control and moving horizon estimation, numerical algorithms for (nonlinear) dynamic optimization and real-time control applications. His doctoral research was focused on numerical simulation methods with efficient sensitivity propagation for real-time optimal control algorithms.



Arvind U. Raghunathan *Ph.D., Carnegie Mellon University, 2004*
Senior Principal Research Scientist

Arvind's research focuses on algorithms for optimization of large-scale nonlinear and mixed integer nonlinear programs with applications in power grid, transportation systems and model-based control of processes. He previously worked at the United Technologies Research Center for 7 years developing optimization algorithms for aerospace, elevator, energy systems and security businesses.



Zafer Sahinoglu *Ph.D., New Jersey Institute of Technology, 2001*
MBA, Massachusetts Institute of Technology, 2013
Senior Business Strategist, Senior Principal Research Scientist

Zafer worked at AT&T's Shannon Research Labs as a visiting researcher in 2001, and then joined Mitsubishi Electric Research Labs. He has served in officer positions in numerous international standards in the areas of smart-grid, electric vehicles, indoor localization, wireless communications and sensor networks; and written two books published by Cambridge Univ. Press.



Alan Sullivan *Ph.D., University of California at Berkeley, 1993*
Computer Vision Group Manager

First at U.C. Berkeley, then at Lawrence Livermore National Laboratory, Alan studied interactions between ultra-high intensity femtosecond lasers and plasmas. Prior to joining MERL in 2007, he worked at a series of start-ups where he developed a novel volumetric 3D display technology. At MERL His research interests include computational geometry and computer graphics.



Hongbo Sun *Ph.D., Chongqing University, 1991*
Senior Principal Research Scientist

Prior to Joining MERL in 2010, Hongbo was a principal applications Engineer at Oracle, and a technical architect at SPL WorldGroup. He is a registered Professional Engineer with more than 20 years' experience in technical consulting, product development and research on electrical transmission and distribution system planning, analysis, and automation.



Huifang Sun *Ph.D., University of Ottawa, 1986*
MERL Fellow / IEEE Fellow

After four years as a Professor at Fairleigh Dickinson University, Huifang moved to the Sarnoff Research Laboratory in 1990 becoming Technology Leader for Digital Video Communication. In 1995, Huifang joined MERL as the leader of MERL's video efforts. In recognition of his productive career in video processing, Huifang was made an IEEE Fellow in 2001.

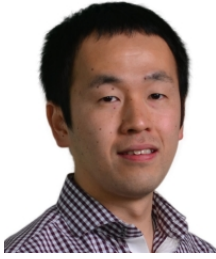

Yuichi Taguchi *Ph.D. The University of Tokyo, 2009*
Senior Principal Research Scientist

Yuichi worked on light field compression and conversion techniques for 3D TV during his Ph.D. After joining MERL in 2009, he has worked on algorithms and sensors for industrial robotics and catadioptric imaging. His current research interests include computational photography and 3D reconstruction.



Koon Hoo Teo *Ph.D., University of Alberta 1990*
Senior Principal Research Scientist, Power & Devices Team Leader

Koon Hoo was with Nortel for 15 years where he was actively involved in the research and implementation of 3G and 4G wireless systems. His work at MERL includes Cognitive Radio, Game Theory and Wireless Mesh for WiMAX and LTE systems. His current areas of research include Metamaterials, Power Amplifiers and Power Devices.



Jay E. Thornton *Ph.D., University of Michigan, 1982*
Mechatronics Group Manager

Prior to joining MERL in 2002, Jay worked at Polaroid Corporation for many years on human vision and image science problems concerning color reproduction, image quality, half toning, and image processing. At MERL he has become absorbed in research on vision for robotics, medical imaging, computational photography, computer human observation, dictionary learning, and processing of the 3D world.



Dong Tian *Ph.D., Beijing University of Technology, 2001*
Senior Principal Research Scientist

Dong has been working in the field of image/video compression and processing for over 10 years. He was deeply involved in the standardization of H.264/MPEG-4 AVC, and then worked for its extension Multiview Video Coding. After joining MERL in 2010, he has continued research in 3D video coding/processing and has been an active participant in the 3DV group.



Hironori Tsukamoto *Ph.D., Tokyo Institute of Technology, 1999*
Patent Agent

Tsukamoto worked as a research scientist in the area of silicon and compound semiconductor materials/devices at Sony Research Center and Yale University for more than 15 years. Prior to joining MERL, he worked at a Japanese Patent Firm to support US patent practice of Japanese client companies for more than 5 years. His area of practice includes electrical engineering, semiconductor technology, software, and medical device.



Jeroen van Baar *Ph.D., ETH Zurich, 2013*
Senior Principal Research Scientist

Jeroen came to MERL in 1997 as intern, and was subsequently hired as research associate. He temporarily left MERL to pursue a Ph.D. and returned early 2013. At MERL he has made contributions in the areas of computer graphics, computer vision and computational photography. His interests include 3D reconstruction, medical imaging, GP-GPU for computational photography and computer vision.



Gene V. Vinokur *J.D., Suffolk University Law School, 2011*
Senior Patent Counsel

Gene graduated cum laude with distinction in Intellectual Property law. In addition, he holds advanced degrees in Mechanical Engineering and Computer Science. He is a member of Massachusetts Bar and has been a licensed patent practitioner since 2003.



Bingnan Wang *Ph.D., Iowa State University 2009*
Principal Research Scientist

Bingnan's doctoral work focused on the study of wave propagation in novel electromagnetic materials, including photonic crystals and meta-materials. His research interests include electromagnetics and photonics, and their applications to communications, imaging, and energy systems.



Pu Wang *Ph.D., Stevens Institute of Technology, 2011*
Research Scientist

Before coming to MERL, Pu was a Research Scientist in the Mathematics and Modeling Department of Schlumberger-Doll Research, contributing to development of logging-while-drilling Acoustic/NMR products. His current research interests include statistical signal processing, Bayesian inference, sparse signal recovery, and their applications to sensing, wireless communications, and networks.

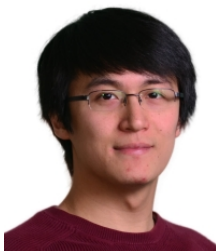

Ye Wang *Ph.D., Boston University, 2011*
Research Scientist

Ye was a member of the Information Systems and Sciences Laboratory at Boston University, where he studied information-theoretically secure multiparty computation. His current research interests include information security, biometric authentication, and data privacy.



Yebin Wang *Ph.D., University of Alberta, 2008*
Senior Principal Research Scientist

Prior to joining MERL, Yebin worked on process control, software development and management, and nonlinear estimation theory for over ten years. Yebin's research interests include nonlinear estimation/control theory and applications, optimal control, adaptive/learning systems, modeling and control of complex systems.



Shinji Watanabe *Ph.D., Waseda University, 2006*
Senior Principal Research Scientist

Prior to joining MERL in 2012, Shinji was a research scientist at NTT Communication Science Laboratories in Japan for 10 years, working on Bayesian learning for speech recognition, speaker adaptation, and language modeling. His research interests include speech recognition, spoken language processing, and machine learning.



Avishai Weiss *Ph.D., University of Michigan, 2013*
Research Scientist

Avishai's doctoral research was on spacecraft orbital and attitude control. Prior to the University of Michigan, he studied at Stanford University, where he received a B.S. in Electrical Engineering and an M.S. in Aeronautics and Astronautics. Avishai's interests are in constrained control, model predictive control, and time-varying systems.



Kent Wittenburg *Ph.D., University of Texas at Austin, 1986*
Director, Licensing

Kent manages MERL's intellectual property activities. He was formerly a lab Director at MERL for 9 years. Prior to joining MERL, he held positions at the Microelectronics and Computer Technology Corporation (MCC), Bellcore and Verizon/GTE Laboratories. His research interests have included natural language processing, multimodal interfaces, visual languages, and information visualization. He is a Senior Member of the ACM.



Victoria Wong
Principal Staff Accountant

Victoria has over 10 years' experience primarily focusing on accounts payable and payroll. She joined MERL in June, 2008. Prior to joining MERL, she was an intern with Federal Reserve Bank of Boston and EF Education. Her Bachelors of Science degree is in Accounting Information Systems.



William S. Yerazunis *Ph.D., Rensselaer Polytechnic Institute, 1987*
Senior Principal Research Scientist

Bill has worked in numerous fields, including parallel computation, SETI, jet engine production, real-time signal processing, expert systems, pattern recognition, text classification, wireless power, and meta-materials. He is the author of the CRM114 spam filter, and was voted one of the 50 most important people in computer network security by Network World magazine.



Ziming Zhang *Ph.D., Oxford Brookes University, 2013*
Research Scientist

Before joining MERL he was a research assistant professor at Boston University, MA. His research interest lies in computer vision and machine learning, including object recognition and detection, zero-shot learning, optimization, etc. His works have appeared in TPAMI, CVPR, ICCV, ECCV, ACM MM and NIPS.

Publications

The following lists the major publications by members of the MERL staff during the period of this report. A publication is considered major if it appeared in a refereed journal, a refereed conference proceeding or some other significant publication such as a book.

Wang, P.; Orlik, P.V.; Sadamoto, K.; Tsujita, W.; Sawa, Y., “**Cramer-Rao Bounds for A Coupled Mixture of Polynomial Phase and Sinusoidal FM Signals**”, *IEEE Signal Processing Letters*, DOI: 10.1109/LSP.2017.2689761, vol. 24, no. 6, pp. 746-750, March 2017 ([TR2017-039](#))

Knyazev, A., Malyshev, A., “**Least squares dynamics in Newton-Krylov Model Predictive Control**”, March 2017, ([TR2017-037](#))

Koike-Akino, T.; Wang, Y.; Draper, S.C.; Sugihara, K.; Matsumoto, W.; Millar, D.S.; Parsons, K.; Kojima, K., “**Bit-Interleaved Polar-Coded Modulation for Low-Latency Short-Block Transmission**”, *Optical Fiber Communication Conference and Exposition and the National Fiber Optic Engineers Conference (OFC/NFOEC)*, DOI: 10.1364/OFC.2017.W1J.6, March 2017 ([TR2017-024](#))

Koike-Akino, T.; Yoshida, T.; Parsons, K.; Millar, D.S.; Kojima, K.; Pajovic, M., “**Fully-Parallel Soft-Decision Cycle Slip Recovery**”, *Optical Fiber Communication Conference and Exposition and the National Fiber Optic Engineers Conference (OFC/NFOEC)*, DOI: 10.1364/OFC.2017.W2A.56, March 2017 ([TR2017-023](#))

Koike-Akino, T.; Parsons, K.; Millar, D.S.; Kojima, K., “**Lattice Precoding for IM/DD POF Interconnects**”, *Optical Fiber Communication Conference and Exposition and the National Fiber Optic Engineers Conference (OFC/NFOEC)*, DOI: 10.1364/OFC.2017.W1J.4, March 2017 ([TR2017-022](#))

Kojima, K.; Yoshida, T.; Parsons, K.; Koike-Akino, T.; Millar, D.S.; Matsuda, K., “**Nonlinearity-tolerant time domain hybrid modulation for 4-8 bits/symbol based on 2A8PSK**”, *Optical Fiber Communication Conference and Exposition (OFC)*, DOI: 10.1364/OFC.2017.W4A.5, March 2017 ([TR2017-025](#))

Millar, D.S.; Pajovic, M.; Koike-Akino, T.; Kojima, K.; Parsons, K., “**A Simplified Dual-Carrier DP-64QAM 1 Tb/s Transceiver**”, *Optical Fiber Communication Conference and Exposition (OFC)*, DOI: 10.1364/OFC.2017.M3D.2, March 2017 ([TR2017-026](#))

Boufounos, P.T.; Rane, S.D.; Mansour, H., “**Representation and Coding of Signal Geometry**”, *Information and Inference: a Journal of the IMA*, March 2017 ([TR2017-036](#))

Watanabe, S.; Hori, T.; Hayashi, T.; Kim, S., “**End-to-end ASR without using morphological analyzer, pronunciation dictionary and language model**”, *Acoustical Society of Japan Spring Meeting (ASJ)*, March 2017 ([TR2017-021](#))

Li, Q.; Liu, S.; Mansour, H.; Wakin, M.; Yang, D.; Zhu, Z., “**Jazz: A Companion to Music for Frequency Estimation with Missing Data**”, *IEEE International Conference on Acoustics, Speech, and Signal Processing (ICASSP)*, March 2017 ([TR2017-013](#))

Wang, Y.; Raval, N.J.; Ishwar, P.; Hattori, M.; Hirano, T.; Matsuda, N.; Shimizu, R., “**On Methods for Privacy-Preserving Energy Disaggregation**”, *IEEE International Conference on Acoustics, Speech, and Signal Processing (ICASSP)*, March 2017 ([TR2017-015](#))

Kao, J.-Y.; Tian, D.; Mansour, H.; Ortega, A.; Vetro, A., “**Disc-Glasso: Discriminative Graph Learning with Sparsity Regularization**”, *IEEE International Conference on Acoustics, Speech, and Signal Processing (ICASSP)*, March 2017 ([TR2017-018](#))

Meng, Z.; Watanabe, S.; Hershey, J.R.; Erdogan, H., “**Deep Long Short-Term Memory Adaptive Beamforming Networks for Multichannel Robust Speech Recognition**”, *IEEE International Conference on Acoustics, Speech, and Signal Processing (ICASSP)*, March 2017 ([TR2017-012](#))

Watanabe, S.; Hori, T.; Le Roux, J.; Hershey, J.R., “**Student- Teacher Network Learning with Enhanced Features**”, *IEEE International Conference on Acoustics, Speech, and Signal Processing (ICASSP)*, March 2017 ([TR2017-011](#))

Chen, S.; Tian, D.; Feng, C.; Vetro, A.; Kovacevic, J., “**Contour-Enhanced Resampling of 3D Point Clouds Via Graphs**”, *IEEE International Conference on Acoustics, Speech, and Signal Processing (ICASSP)*, March 2017 ([TR2017-017](#))

Liu, H.-Y.; Kamilov, U.; Liu, D.; Mansour, H.; Boufounos, P.T., “**Compressive Imaging with Iterative Forward Models**”, *IEEE International Conference on Acoustics, Speech, and Signal Processing (ICASSP)*, March 2017 ([TR2017-009](#))

Kim, S.; Hori, T.; Watanabe, S., “**Joint CTC- Attention Based End-to-End Speech Recognition Using Multi-task Learning**”, *IEEE International Conference on Acoustics, Speech, and Signal Processing (ICASSP)*, March 2017 ([TR2017-016](#))

Luo, Y.; Chen, Z.; Hershey, J.R.; Le Roux, J.; Mesgarani, N., “**Deep Clustering and Conventional Networks for Music Separation: Strong Together**”, *IEEE International Conference on Acoustics, Speech, and Signal Processing (ICASSP)*, March 2017 ([TR2017-010](#))

Hayashi, T.; Watanabe, S.; Toda, T.; Hori, T.; Le Roux, J.; Takeda, K., “**BLSTM-HMM Hybrid System Combined with Sound Activity Detection Network for Polyphonic Sound Event Detection**”, *IEEE International Conference on Acoustics, Speech, and Signal Processing (ICASSP)*, March 2017 ([TR2017-014](#))

Koike-Akino, T.; Kojima, K.; Millar, D.S.; Parsons, K.; Yoshida, T.; Sugihara, T., “**Pareto Optimization of Adaptive Modulation and Coding Set in Nonlinear Fiber-Optic Systems**”, *IEEE Journal of Lightwave Technology*, DOI: 10.1109/JLT.2016.2604561, vol. 35, no. 4, pp. 1041 - 1049, February 2017 ([TR2017-027](#))

Yu, L.; Goldsmith, A.M.; Di Cairano, S., “**Efficient Convex Optimization on GPUs for Embedded Model Predictive Control**”, *Workshop on General Purpose Processing with Graphics Processing Units*, DOI: 10.1145/3038228.3038234, pp. 12-21, February 2017 ([TR2017-033](#))

Tripathi, A.; Grover, P.; Kalmar-Nagy, T., “**On optimal performance of nonlinear energy sinks in multiple-degree-of-freedom systems**”, *Journal of Sound and Vibration*, DOI: 10.1016/j.jsv.2016.10.025, vol. 388, pp. 272-297, February 2017 ([TR2017-003](#))

Kojima, K.; Yoshida, T.; Koike-Akino, T.; Millar, D.S.; Parsons, K.; Arlunno, V., “**Nonlinearity-tolerant four-dimensional 2A8PSK family for 5-7 bits/symbol spectral efficiency**”, *IEEE Journal of Lightwave Technology*, DOI: 10.1109/JLT.2017.2662942, vol. 35, no. 8, pp. 1383-1391, February 2017 ([TR2017-038](#))

Kamilov, U., “**A Parallel Proximal Algorithm for Anisotropic Total Variation Minimization**”, *IEEE Transactions on Image Processing*, DOI: 10.1109/TIP.2016.2629449, vol. 26, no. 2, pp. 539-548, February 2017 ([TR2017-002](#))

Khan, T.; Orlik, P.V.; Kim, K.J.; Heath, R.W.; Sawa, K., “**A Stochastic Geometry Analysis of Large-Scale Cooperative Wireless Networks Powered by Energy Harvesting**”, *IEEE Transactions on Communications*, DOI: 10.1109/TCOMM.2016.2623314, January 2017 ([TR2017-030](#))

Millar, D.S.; Koike-Akino, T.; Kojima, K.; Parsons, K., “**Multidimensional modulation for next-generation transmission systems**”, *SPIE. Photonics West*, DOI: 10.1117/12.2254844, vol. 10130, January 2017 ([TR2017-029](#))

Kamilov, U.; Boufounos, P.T., “**Motion-Adaptive Depth Superresolution**”, *IEEE Transactions on Image Processing*, DOI: 10.1109/TIP.2017.2658944, vol. 26, no. 4, pp. 1723- 1731, January 2017 ([TR2017-040](#))

Lin, C.; Wang, B.; Teo, K.H., “**The role of local repulsion in superconductivity in the Hubbard-Holstein model**”, *Physica C*, DOI: 10.1016/j.physc.2016.11.011, vol. 532, pp. 27-32, January 2017 ([TR2017-007](#))

Nakatani, K.; Shinjo, S.; Miwa, S.; Ma, R.; Yamanaka, K., “**3.0-3.6 GHz Wideband, over 46% Average Efficiency GaN Doherty Power Amplifier with Frequency Dependency Compensating Circuits**”, *IEEE Radio Wireless Week (RWW)*, January 2017 ([TR2017-005](#))

Tanovic, O.; Ma, R.; Teo, K.H., “**Novel Baseband Equivalent Models of Quadrature Modulated All-Digital Transmitters**”, *IEEE Radio Wireless Week (RWW)*, January 2017 ([TR2017-006](#))

Knyazev, A., “**Signed Laplacian for Spectral Clustering Revisited**”, *arXiv*, January 2017 ([TR2017-001](#))

Zhu, P.; Knyazev, A., “**Rayleigh-Ritz Majorization Error Bounds of the Mixed Type**”, *SIAM Journal on Matrix Analysis and Applications*, DOI: 10.1137/16M1058121, vol. 38, no. 1, pp. 30-49, January 2017 ([TR2017-004](#))

Zhang, C.; Wang, B.; Teo, K.H., “**Design of Continuous Beam Steerable and Scalable Unit Module for Wireless Power Transmission Using Injection-locked Oscillator Array**”, *Journal of Progress In Electromagnetics Research (PIER)*, DOI: 10.2528/PIERC16081805, vol. 69, pp. 169-179, December 2016 ([TR2016-168](#))

Wang, P.; Orlik, P.V.; Sadamoto, K.; Tsujita, W., “**Parameter Estimation of Hybrid Sinusoidal FM-Polynomial Phase Signal**”, *IEEE Signal Processing Letters*, DOI: 10.1109/LSP.2016.2638436, vol. 24, no. 1, pp. 66-70, December 2016 ([TR2016-158](#))

Vecharynski, E.; Knyazev, A., “**Preconditioned steepest descent-like methods for symmetric indefinite systems**”, *Linear Algebra and its Applications*, vol. 511, pp. 274-295, December 2016 ([TR2016-165](#))

Xiao, X.; Watanabe, S.; Chng, E.S.; Li, H., “**Beamforming Networks Using Spatial Covariance Features for Far-field Speech Recognition**”, *Asian-Pacific Signal and Information Processing Association Annual Summit and Conference*, DOI: 10.1109/APSIPA.2016.7820724, December 2016 ([TR2016-162](#))

Hori, T.; Wang, H.; Hori, C.; Watanabe, S.; Harsham, B.A.; Le Roux, J.; Hershey, J.R.; Koji, Y.; Jing, Y.; Zhu, Z.; Aikawa, T., “**Dialog State Tracking with Attention-based Sequence-to-sequence Learning**”, *IEEE Workshop on Spoken Language Technology (SLT)*, DOI: 10.1109/SLT.2016.7846317, pp. 552 – 558, December 2016 ([TR2016-163](#))

Farahmand, A.-M.; Nabi, S.; Grover, P.; Nikovski, D.N., “**Learning to Control Partial Differential Equations: Regularized Fitted Q-Iteration Approach**”, *IEEE Conference on Decision and Control (CDC)*, DOI: 10.1109/CDC.2016.7798966, pp. 4578 – 4585, December 2016 ([TR2016-145](#))

Danielson, C.; Weiss, A.; Berntorp, K.; Di Cairano, S., “**Path Planning using Positive Invariant Sets**”, *IEEE Annual Conference on Decision and Control (CDC)*, DOI: 10.1109/CDC.2016.7799188, pp. 5986-5991, December 2016 ([TR2016-160](#))

Berntorp, K.; Di Cairano, S., “**Tire-Stiffness Estimation by Marginalized Adaptive Particle Filter**”, *IEEE Annual Conference on Decision and Control (CDC)*, DOI: 10.1109/CDC.2016.7798628, pp. 2443-2448, December 2016 ([TR2016-147](#))

Berntorp, K.; Di Cairano, S., “**Process-Noise Adaptive Particle Filtering with Dependent Process and Measurement Noise**”, *IEEE Annual Conference on Decision and Control (CDC)*, DOI: 10.1109/CDC.2016.7799103, pp. 5434-5439, December 2016 ([TR2016-148](#))

Di Cairano, S.; Kalabic, U.; Berntorp, K., “**Vehicle Tracking Control on Piecewise-Clothoidal Trajectories by MPC with Guaranteed Error Bounds**”, *IEEE Conference on Decision and Control (CDC)*, DOI: 10.1109/CDC.2016.7798351, pp. 709 – 714, December 2016 ([TR2016-159](#))

Laftchiev, E.; Nikovski, D.N., “**An IoT System to Estimate Personal Thermal Comfort**”, *IEEE World Forum on Internet of Things (WF- IoT)*, DOI: 10.1109/WF-IoT.2016.7845401, pp. 672 – 677, December 2016 ([TR2016-161](#))

Takano, T., Moriya, T., Shinozaki, T., Watanabe, S., Hori, T., “**Automated structure discovery and parameter tuning of neural network language model based on evolution strategy**”, *IEEE Spoken Language Technology (SLT) Workshop*, DOI: 10.1109/SLT.2016.7846334, December 2016 ([TR2016-173](#))

Tian, D.; Sun, H.; Vetro, A., “**Graph Transformation for Keypoint Trajectory Coding**”, *IEEE Global Conference on Signal and Information Processing (GlobalSIP)*, DOI: 10.1109/GlobalSIP.2016.7905881, pp. 445 – 449, December 2016 ([TR2016-157](#))

Peng, W.-H.; Walls, F.; Cohen, R.A.; Xu, J.; Ostermann, J.; MacInnis, A.; Lin, T., “**Overview of Screen Content Video Coding: Technologies, Standards, and Beyond**”, *IEEE Journal on Emerging and Selected Topics in Circuits and Systems*, DOI: 10.1109/JETCAS.2016.2608971, vol. 6, pp. 393 - 408, December 2016 ([TR2016-167](#))

Wisdom, S.; Powers, T.; Hershey, J.R.; Le Roux, J.; Atlas, L., “**Full-Capacity Unitary Recurrent Neural Networks**”, *Advances in Neural Information Processing Systems (NIPS)*, December 2016 ([TR2016-155](#))

Liu, M.-Y.; Tuzel, C.O.; Sullivan, A., “**Coupled Generative Adversarial Nets**”, *Advances in Neural Information Processing Systems (NIPS)*, December 2016 ([TR2016-156](#))

Fujihashi, T.; Koike-Akino, T.; Watanabe, T.; Orlik, P.V., “**Experimental Throughput Analysis in Screen-Camera Visual MIMO Communications**”, *IEEE Global Communications Conference (GLOBECOM)*, DOI: 10.1109/GLOCOM.2016.7841827, December 2016 ([TR2016-169](#))

Farahmand, A.-M.; Barreto, A.M.S.; Nikovski, D.N., “**Value-Aware Loss Function for Model Learning in Reinforcement Learning**”, *European Workshop on Reinforcement Learning (EWRL)*, December 2016 ([TR2016-153](#))

Yeoh, P.L.; Kim, K.J.; Orlik, P.V.; Poor, H.V., “**Secrecy Performance of Cooperative Single Carrier Systems with Unreliable Backhaul Connections**”, *IEEE Global Communications Conference (GLOBECOM)*, DOI: 10.1109/GLOCOM.2016.7842247, December 2016 ([TR2016-154](#))

Boufounos, P.T.; Rane, S.D.; Mansour, H., “**Embedding-based Representation of Signal Geometry**”, *Excursions in Harmonic Analysis*, December 2016 ([TR2016-152](#))

Laughman, C.R.; Qiao, H., “**On the Influence of State Selection on Mass Conservation in Dynamic Vapor Compression Cycle Models**”, *Mathematical and Computer Modeling of Dynamical Systems*, DOI: 10.1080/13873954.2017.1298625, vol. 23, no. 3, pp. 262-283, December 2016 ([TR2016-151](#))

Barker, J., Marxer, R., Vincent, E., Watanabe, S., “**The Third 'CHIME' Speech Separation and Recognition Challenge: Analysis and Outcomes**”, *Computer Speech & Language*, DOI: 10.1016/j.csl.2016.10.005, December 2016 ([TR2016-171](#))

Vincent, E., Watanabe, S., Nugraha, A.A., Barker, J., Marxer, R., “**An analysis of environment, microphone and data simulation mismatches in robust speech recognition**”, *Computer Speech & Language*, DOI: 10.1016/j.csl.2016.11.005, December 2016 ([TR2016-172](#))

Xiao, Y.; Feng, C.; Taguchi, Y.; Kamat, V.R., “**User-Guided Dimensional Analysis of Indoor Building Environments from Single Frames of RGB-D Sensors**”, *Journal of Computing in Civil Engineering*, DOI: 10.1061/(ASCE)CP.1943-5487.0000648#sthash.qf8wYMXI.dpuf, vol. 31, no. 4, November 2016 ([TR2016-150](#))

Chen, C.; Liu, M.-Y.; Tuzel, C.O.; Xiao, J.; Sullivan, A., “**R-CNN for Small Object Detection**”, *Asian Conference on Computer Vision (ACCV)*, DOI: 10.1007/978-3-319-54193-8_14, vol. 10115, pp. 214-230, November 2016 ([TR2016-144](#))

Wang, B.; Yerazunis, W.S.; Teo, K.H., “**Wireless Power Transfer based on Metamaterials**”, *Wireless Power Transfer Algorithms, Technologies and Applications in Ad Hoc Communication Networks*, DOI: 10.1007/978-3-319-46810-5_3, pp. 31-53, November 2016 ([TR2016-166](#))

Benosman, M.; Wei, C., “**Extremum Seeking-based Parameter Identification for State-of-Power Prediction of Lithium-ion Batteries**”, *IEEE International Conference on Renewable Energy Research and Applications (ICRERA)*, DOI: 10.1109/ICRERA.2016.7884376, pp. 67 – 72, November 2016 ([TR2016-143](#))

Zhang, C.; Wang, B.; Ishimaru, A.; Kuga, Y., “**Optimal Array Beamforming for Microwave Power Transmission in Complex Environment**”, *Wireless Power Transfer Algorithms, Technologies and Applications in Ad Hoc Communication Networks*, DOI: 10.1007/978-3-319-46810-5_3, pp. 55-83, November 2016 ([TR2017-032](#))

Wang, J.; Wang, B.; Lin, C.; Teo, K.H., “**Thermal Emitter Design based on Gap and Spacer Plasmon Mode Coupling**”, *OSA Light, Energy and the Environment Congress*, DOI: 10.1364/PV.2016.PTh4A.4, November 2016 ([TR2016-142](#))

Wang, B.; Teo, K.H.; Orlik, P.V., “**An Accurate Contactless Position Sensor with Planar Resonators**”, *IEEE Sensors*, DOI: 10.1109/ICSENS.2016.7808939, November 2016 ([TR2016-139](#))

Liu, H.; Kim, K.J.; Kwak, K.S.; Poor, H.V., “**Power Splitting-Based SWIPT with Decode-and-Forward Full-Duplex Relaying**”, *IEEE Transactions on Wireless Communications*, DOI: 10.1109/TWC.2016.2604801, ISSN: 1536-1276, vol. 15, pp. 7561-7577, November 2016 ([TR2016-141](#))

Wang, Y.; Fang, H.; Zhou, L.; Wada, T., “**Revisiting the State of Charge Estimation for Lithium-Ion Batteries A Methodical Investigation of the EKF Approach**”, *IEEE Control Systems Magazine*, October 2016 ([TR2016-137](#))

Tawara, N.; Ogawa, T.; Watanabe, S.; Kobayashi, T., “**Nested Gibbs sampling for mixture-of-mixture model and its application to speaker clustering**”, *APSIPA Transactions on Signal and Information Processing*, DOI: 10.1017/ATSIP.2016.15, vol. 5, October 2016 ([TR2016-138](#))

Ozcan, G.; Pajovic, M.; Sahinoglu, Z.; Wang, Y.; Orlik, P.V.; Wada, T., “**Online State of Charge Estimation for Lithium-Ion Batteries Using Gaussian Process Regression**”, *Annual Conference of IEEE Industrial Electronics Society (IECON)*, DOI: 10.1109/IECON.2016.7793002, pp. 998-1003, October 2016 ([TR2016-136](#))

Brand, M.E.; Aksoylar, A., “**Sharp images from freeform optics and extended light sources**”, *OSA Frontiers in Optics*, DOI: 10.1364/FIO.2016.FW5H.2, October 2016 ([TR2016-135](#))

Matsumoto, W.; Hagiwara, M.; Boufounos, P.T.; Fukushima, K.; Mariyama, T.; Xiongxin, Z., “**A Deep Neural Network Architecture Using Dimensionality Reduction with Sparse Matrices**”, *International Conference on Neural Information Processing (ICONIP)*, DOI: 10.1007/978-3-319-46681-1_48, vol. 9950, pp. 397-404, October 2016 ([TR2016-134](#))

Tuzel, C.O.; Marks, T.K.; Tambe, S., “**Robust Face Alignment Using a Mixture of Invariant Experts**”, *European Conference on Computer Vision (ECCV)*, DOI: 10.1007/978-3-319-46454-1_50, vol. 9909, pp. 825-841, October 2016 ([TR2016-129](#))

Sankaran, B.; Ramalingam, S.; Taguchi, Y., “**Parameter Learning for Improving Binary Descriptor Matching**”, *IEEE/RSJ International Conference on Intelligent Robots and Systems (IROS)*, DOI: 10.1109/IROS.2016.7759718, pp. 4892- 4897, October 2016 ([TR2016-132](#))

Ataer-Cansizoglu, E.; Taguchi, Y., “**Object Detection and Tracking in RGB-D SLAM via Hierarchical Feature Grouping**”, *IEEE/RSJ International Conference on Intelligent Robots and Systems (IROS)*, DOI: 10.1109/IROS.2016.7759613, pp. 4164- 4171, October 2016 ([TR2016-133](#))

Sun, H.; Feng, G.; Nikovski, D.N., “**Dynamic State Estimation Based on Unscented Kalman Filter and Very Short-Term Load and Distributed Generation Forecasting**”, *IEEE International Conference on Power System Technology (POWERCON)*, DOI: 10.1109/POWERCON.2016.7753928, September 2016 ([TR2016-128](#))

Cohen, R.A.; Tian, D.; Krivokuca, M.; Sugimoto, K.; Vetro, A.; Wakimoto, K.; Sekiguchi, S.-I., “**Representation and Coding of Large-Scale 3D Dynamic Maps**”, *SPIE Conference on Applications of Digital Image Processing*, DOI: 10.1117/12.2237755, vol. 9971, September 2016 ([TR2016-116](#))

Enoki, K.; Horiguchi, Y.; Kojima, K.; Koike-Akino, T.; Akiyama, K., “**Investigation of the Linewidth of a Tunable Laser Integrated with DFB Lasers and a Semiconductor Optical Amplifier**”, *International Conference on Solid State Devices and Materials*, September 2016 ([TR2016-123](#))

Liu, D.; Kamilov, U.; Boufounos, P.T., “**Compressive Tomographic Radar Imaging with Total Variation Regularization**”, *International Workshop on Compressed Sensing Theory and its Applications to Radar, Sonar, and Remote Sensing (CoSeRa)*, DOI: 10.1109/CoSeRa.2016.7745712, pp. 120-123, September 2016 ([TR2016-091](#))

Liu, D.; Kamilov, U.; Boufounos, P.T., “**Coherent Distributed Array Imaging under Unknown Position Perturbations**”, *International Workshop on Compressed Sensing Theory and its Applications to Radar, Sonar, and Remote Sensing (CoSeRa)*, DOI: 10.1109/CoSeRa.2016.7745709, pp. 105-109, September 2016 ([TR2016-092](#))

Mansour, H.; Kamilov, U.; Liu, D.; Orlik, P.V.; Boufounos, P.T.; Parsons, K.; Vetro, A., “**Online Blind Deconvolution for Sequential Through-the-Wall-Radar-Imaging**”, *International Workshop on Compressed Sensing Theory and its Applications to Radar, Sonar, and Remote Sensing (CoSeRa)*, DOI: 10.1109/CoSeRa.2016.7745700, pp.61- 65, September 2016 ([TR2016-093](#))

Kojima, K.; Yoshida, T.; Koike-Akino, T.; Millar, D.S.; Parsons, K.; Arlunno, V., “**5 and 7 bit/symbol 4D Modulation Formats Based on 2A8PSK**”, *European Conference on Optical Communication (ECOC)*, September 2016 ([TR2016-120](#))

Pajovic, M.; Millar, D.S.; Parsons, K.; Matsuda, K.; Miura, H.; Kojima, K.; Koike-Akino, T.; Yoshida, T., “**Cross Polarization Modulation (XPoLM) Compensation for Submarine Upgrade Links using DP-8QAM**”, *European Conference on Optical Communication (ECOC)*, September 2016 ([TR2016-122](#))

Yoshida, T.; Matsuda, K.; Kojima, K.; Miura, H.; Dohi, K.; Pajovic, M.; Koike-Akino, T.; Millar, D.S.; Parsons, K.; Sugihara, T., “**Hardware-efficient Precise and Flexible Soft-demapping for Multi-Dimensional Complementary APSK Signals**”, *European Conference on Optical Communication (ECOC)*, September 2016 ([TR2016-121](#))

Koike-Akino, T.; Sugihara, K.; Millar, D.S.; Pajovic, M.; Matsumoto, W.; Maher, R.; Lavery, D.; Abad, A.; Paskov, M.; Kojima, K.; Parsons, K.; Thomsen, B.C.; Savory, S.J.; Bayvel, P., “**Experimental Demonstration of Nonbinary LDPC Convolutional Codes for DP-64QAM/256QAM**”, *European Conference on Optical Communication (ECOC)*, September 2016 ([TR2016-125](#))

Koike-Akino, T.; Draper, S.C.; Wang, Y.; Sugihara, K.; Matsumoto, W.; Millar, D.S.; Parsons, K.; Arlunno, V.; Kojima, K., “**Optimal Layered Scheduling for Hardware-Efficient Windowed Decoding of LDPC Convolutional Codes**”, *European Conference on Optical Communication (ECOC)*, September 2016 ([TR2016-124](#))

Cohen, R.A.; Tian, D.; Vetro, A., “**Attribute compression for sparse point clouds using graph transforms**”, *IEEE International Conference on Image Processing (ICIP)*, DOI: 10.1109/ICIP.2016.7532583, pp. 1374-1378, September 2016 ([IEEE Xplore](#), [TR2016-112](#))

Valsesia, D.; Boufounos, P.T., “**Multispectral Image Compression Using Universal Vector Quantization**”, *IEEE Information Theory Workshop (ITW)*, DOI: 10.1109/ITW.2016.7606814, pp. 151-155, September 2016 ([TR2016-119](#))

Zmolikova, K.; Karafiat, M.; Vesely, K.; Delcroix, M.; Watanabe, S.; Burget, L.; Cernocky, J.H., “**Data selection by sequence summarizing neural network in mismatch condition training**”, *Interspeech*, DOI: 10.21437/Interspeech.2016-741, pp. 2354-2358, September 2016 ([TR2016-075](#))

Le Roux, J.; Vincent, E.; Erdogan, H., “**Learning- Based Approaches to Speech Enhancement and Separation**”, *Interspeech Tutorials*, September 2016 ([TR2016-113](#))

- Erdogan, H.; Hershey, J.R.; Watanabe, S.; Mandel, M.; Le Roux, J., “**Improved MVDR beamforming using single-channel mask prediction networks**”, *Interspeech*, DOI: 10.21437/Interspeech.2016-552, pp. 1981-1985, September 2016 ([TR2016-072](#))
- Delcroix, M.; Watanabe, S., “**Recent Advances in Distant Speech Recognition**”, *Interspeech Tutorials*, September 2016 ([TR2016-115](#))
- Isik, Y.; Le Roux, J.; Chen, Z.; Watanabe, S.; Hershey, J.R., “**Single-Channel Multi-Speaker Separation using Deep Clustering**”, *Interspeech*, DOI: 10.21437/Interspeech.2016-1176, pp. 545-549, September 2016 ([TR2016-073](#))
- Hori, C.; Hori, T.; Watanabe, S.; Hershey, J.R., “**Context-Sensitive and Role-Dependent Spoken Language Understanding using Bidirectional and Attention LSTMs**”, *Interspeech*, DOI: 10.21437/Interspeech.2016-1171, pp. 3236-3240, September 2016 ([TR2016-074](#))
- Wei, C.; Benosman, M., “**Extremum Seeking-based Adaptive Voltage Control of Distribution Systems with High PV Penetration**”, *IEEE Power & Energy Society Innovative Smart Grid Technologies Conference (ISGT)*, DOI: 10.1109/ISGT.2016.7781199, September 2016 ([TR2016-131](#))
- Sun, H.; Minot, A.; Nikovski, D.N.; Hashimoto, H.; Takano, T.; Takaguchi, Y., “**Mitigating Substation Demand Fluctuations Using Decoupled Price Schemes for Demand Response**”, *IEEE Power & Energy Society Innovative Smart Grid Technologies Conference (ISGT)*, DOI: 10.1109/ISGT.2016.7781189, September 2016 ([TR2016-118](#))
- Hayashi, T.; Watanabe, S.; Toda, T.; Hori, T.; Le Roux, J.; Takeda, K., “**Bidirectional LSTM-HMM Hybrid System for Polyphonic Sound Event Detection**”, *Detection and Classification of Acoustic Scenes and Events Workshop*, pp. 35-39, September 2016 ([TR2016-114](#))
- Kim, K.J.; Yeoh, P.L.; Orlik, P.V.; Poor, H.V., “**Secrecy Performance of Finite-Sized Cooperative Single Carrier Systems with Unreliable Backhaul Connections**”, *IEEE Transactions on Signal Processing*, DOI: 10.1109/TSP.2016.2552508, vol. 64, no. 17, pp. 4403-4416, September 2016 ([TR2016-106](#))
- Ma, R.; Shao, J.; Shinjo, S.; Teo, K.H., “**Design of Broadband Three-way Sequential Power Amplifiers**”, *IEEE International Symposium on Radio-Frequency Integration Technology (RFIT)*, DOI: 10.1109/RFIT.2016.7578196, August 2016 ([TR2016-110](#))
- Kamilov, U.; Mansour, H., “**Learning MMSE Optimal Thresholds for FISTA**”, *International Traveling Workshop on Interactions Between Sparse Models and Technology (iTWIST)*, August 2016 ([TR2016-111](#))

Kamilov, U. S., “**Minimizing Isotropic Total Variation without Subiterations**”, *International Traveling Workshop on Interactions Between Sparse Models and Technology (iTWIST)*, August 2016 ([TR2016-109](#))

Danielson, C.; Di Cairano, S., “**Robust Soft-Landing Control with Quantized Input**”, *Symposium on Nonlinear Control Systems*, DOI: 10.1016/j.ifacol.2016.10.136, vol. 49, no. 18, pp. 35-40, August 2016 ([TR2016-108](#))

Laughman, C.R.; Qiao, H.; Nikovski, D.N., “**Kernel Regression for the Approximation of Heat Transfer Coefficients**”, *Gustav Lorentzen Natural Working Fluids Conference*, August 2016 ([TR2016-107](#))

Tian, D.; Sun, H.; Vetro, A., “**Keypoint trajectory coding on compact descriptor for video analysis**”, *IEEE International Conference on Image Processing (ICIP)*, DOI: 10.1109/ICIP.2016.7532341, pp. 171 - 175, August 2016 ([TR2016-127](#))

Kao, J.-Y.; Tian, D.; Mansour, H.; Vetro, A.; Ortega, A., “**Moving object segmentation using depth and optical flow in car driving sequences**”, *IEEE International Conference on Image Processing (ICIP)*, DOI: 10.1109/ICIP.2016.7532309, pp. 11- 15, August 2016 ([TR2016-126](#))

Zhang, J.; Kim, K.J.; Li, Q.; Wang, Y.; Ge, X.; Zhang, J., “**On the Performance of Full-duplex Two-way Relay Channels with Spatial Modulation**”, *IEEE Transactions on Communications*, DOI: 10.1109/TCOMM.2016.2600661, vol. 64, no. 12, pp. 4966-4982, August 2016 ([TR2017-031](#))

Koike-Akino, T.; Mahajan, R.; Marks, T.K.; Tuzel, C.O.; Wang, Y.; Watanabe, S.; Orlik, P.V., “**High-Accuracy User Identification Using EEG Biometrics**”, *IEEE Engineering in Medicine and Biology Society (EMBC)*, DOI: 10.1109/EMBC.2016.7590835, pp. 854-858, August 2016 ([TR2016-105](#))

Yerazunis, W.S.; Barnwell III, J.C.; Nikovski, D.N., “**Strengthening ABS, Nylon, and Polyester 3D Printed Parts by Stress Tensor Aligned Deposition Paths and Five-Axis Printing**”, *International Solid Freeform Fabrication Symposium*, August 2016 ([TR2016-101](#))

Garone, E.; Di Cairano, S.; Kolmanovsky, I.V., “**Reference and Command Governors for Systems with Constraints: A Survey on Theory and Applications**”, *Automatica*, DOI: 10.1016/j.automatica.2016.08.013, vol. 75, pp. 306- 328, August 2016 ([TR2016-102](#))

Lin, C.; Wang, B.; Teo, K.H., “**Optimal boson energy for superconductivity in the Holstein model**”, *Physical Review B*, DOI: 10.1103/PhysRevB.93.224501, vol. 23, no. 22, July 2016 ([TR2016-100](#))

Nikovski, D.N.; Byadarhaly, K., “**Regularized Covariance Matrix Estimation with High Dimensional Data for Supervised Anomaly Detection Problems**”, *IEEE International Joint Conference on Neural Networks*, DOI: 10.1109/IJCNN.2016.7727554, pp. 2811-2818, July 2016 ([TR2016-099](#))

Wang, Z.; Sun, H.; Nikovski, D.N., “**Distributed secondary voltage controller for droop-controlled microgrids to improve power quality in power distribution networks**”, *IEEE Power & Energy Society General Meeting (PESGM)*, DOI: 10.1109/PESGM.2016.7741071, July 2016 ([TR2016-096](#))

Raghunathan, A.U.; Curtis, F.E.; Takaguchi, Y.; Hashimoto, H., “**Accelerating Convergence to Competitive Equilibrium in Electricity Markets**”, *IEEE Power & Energy Society General Meeting (PESGM)*, DOI: 10.1109/PESGM.2016.7741162, vol. 17, no. 3, pp. 713-727, July 2016 ([TR2016-095](#))

Wang, B.; Kojima, K.; Koike-Akino, T.; Zhao, H.; Klamkin, J., “**Design of InP Chip Output Coupler with Transformation Optics**”, *OSA IPR*, DOI: 10.1364/IPRSN.2016.IW3B.5 July 2016 ([TR2016-098](#))

Ozcan, G.; Pajovic, M.; Sahinoglu, Z.; Wang, Y.; Orlik, P.V., “**Online Battery State-of-Charge Estimation Based on Sparse Gaussian Process Regression**”, *IEEE Power & Energy Society General Meeting*, DOI: 10.1109/PESGM.2016.7741980, July 2016 ([TR2016-097](#))

Knyazev, A.; Gao, Q.; Teo, K.H., “**Multi-exponential Lifetime Extraction in Time-logarithmic Scale**”, *Industrial Conference on Data Mining (ICDM)*, DOI: 10.1007/978-3-319-41561-1_21, vol. 9728, pp. 282-296, July 2016 ([TR2016-062](#))

Kamilov, U.; Boufounos, P.T., “**Depth Superresolution Using Motion Adaptive Regularization**”, *IEEE International Conference on Multimedia and Expo (ICME)*, DOI: 10.1109/ICMEW.2016.7574677, July 2016 ([TR2016-090](#))

Boufounos, P.T.; Mansour, H.; Rane, S.D.; Vetro, A., “**Dimensionality Reduction of Visual Features for Efficient Retrieval and Classification**”, *APSIPA Transactions on Signal and Information Processing*, DOI: 10.1017/ATSIP.2016.14, vol. 5, July 2016 ([TR2016-103](#))

Wang, Y.; Zhou, L.; Bortoff, S.A.; Satake, A.; Furutani, S., “**High gain observer for speed-sensorless motor drives: algorithm and experiments**”, *IEEE International Conference on Advanced Intelligent Mechatronics*, DOI: 10.1109/AIM.2016.7576921, pp. 1127 – 1132, July 2016 ([TR2016-089](#))

Hongtao, Q.; Laughman, C.R., “**Modeling of Finned-Tube Heat Exchangers: A Novel Approach to the Analysis of Heat and Mass Transfer under Cooling and Dehumidifying Conditions**”, *International Refrigeration and Air conditioning Conference at Purdue*, July 2016 ([TR2016-130](#))

- Burns, D.J.; Laughman, C.R.; Guay, M., **“Proportional-Integral Extremum Seeking for Optimizing Power of Vapor Compression Systems”**, *International Refrigeration and Air conditioning Conference at Purdue*, July 2016 ([TR2016-085](#))
- Laughman, C.R.; Qiao, H.; Burns, D.J.; Bortoff, S.A., **“Dynamic Charge Management for Vapor Compression Cycles”**, *Air-Conditioning and Refrigeration Conference at Purdue*, July 2016 ([TR2016-086](#))
- Burns, D.J.; Bortoff, S.A., **“Cooling Capacity Control for Multi-Evaporator Vapor Compression Systems”**, *International Refrigeration and Air conditioning Conference at Purdue*, July 2016 ([TR2016-084](#))
- Dicle, C.; Mansour, H.; Tian, D.; Benosman, M.; Vetro, A., **“Robust Low Rank Dynamic Mode Decomposition for Compressed Domain Crowd and Traffic Flow Analysis”**, *IEEE International Conference on Multimedia and Expo (ICME)*, DOI: 10.1109/ICME.2016.7552877, July 2016 ([TR2016-087](#))
- Hori, C.; Watanabe, S.; Hori, T.; Harsham, B.A.; Hershey, J.R.; Koji, Y.; Fujii, Y.; Furumoto, Y., **“Driver Confusion Status Detection Using Recurrent Neural Networks”**, *IEEE International Conference on Multimedia and Expo (ICME)*, DOI: 10.1109/ICME.2016.7552966, July 2016 ([TR2016-088](#))
- Liu, D., **“Sparsity-Driven Radar Auto-Focus Imaging Under Over-Wavelength Position Perturbations”**, *Sensor Array and Multichannel Signal Processing Workshop (SAM)*, DOI: 10.1109/SAM.2016.7569657, July 2016 ([TR2016-083](#))
- Kim, K.J.; Orlik, P.V.; Khan, T., **“Performance Analysis of Finite-Sized Co-Operative Systems With Unreliable Backhauls”**, *IEEE Transactions on Wireless Communications*, DOI: 10.1109/TWC.2016.2551217, vol. 15, no. 7, pp. 5001 - 5015, July 2016 ([TR2016-094](#))
- Wang, Y.; Wu, J.; Long, C., **“Policy Iteration-based Optimal Control Design for Nonlinear Descriptor Systems”**, *American Control Conference (ACC)*, DOI: 10.1109/ACC.2016.7526569, pp. 5740-5745, July 2016 ([TR2016-051](#))
- Benosman, M.; Farahmand, A.-M., **“Learning-Based Modular Indirect Adaptive Control for a Class of Nonlinear Systems”**, *American Control Conference (ACC)*, DOI: 10.1109/ACC.2016.7525001, pp. 733 – 738, July 2016 ([TR2016-055](#))
- Benosman, M.; Boufounos, P.T.; Grover, P.; Kramer, B., **“Learning-based Reduced Order Model Stabilization for Partial Differential Equations: Application to the Coupled Burgers' Equation”**, *American Control Conference (ACC)*, DOI: 10.1109/ACC.2016.7525157, pp. 1673 – 1678, July 2016 ([TR2016-056](#))

Knyazev, A.; Malyshev, A., “**Sparse Preconditioning for Model Predictive Control**”, *American Control Conference (ACC)*, DOI: 10.1109/ACC.2016.7526060, pp. 4494-4499, July 2016 ([TR2016-046](#))

Zhou, L.; Wang, Y., “**Speed Sensorless State Estimation for Induction Motors: A Moving Horizon Approach**”, *American Control Conference (ACC)*, DOI: 10.1109/ACC.2016.7525249, pp. 2229-2234, July 2016 ([TR2016-054](#))

Zhou, J.; Burns, D.J.; Danielson, C.; Di Cairano, S., “**A Reconfigurable Plug-and-Play Model Predictive Controller for Multi-Evaporator Vapor Compression Systems**”, *American Control Conference (ACC)*, DOI: 10.1109/ACC.2016.7525270, pp. 2358-2364, July 2016 ([TR2016-048](#))

Jha, D.; Zhu, M.; Wang, Y.; Ray, A., “**Data-Driven Anytime Algorithms for Motion Planning with Safety Guarantees**”, *American Control Conference (ACC)*, DOI: 10.1109/ACC.2016.7526565, pp. 5716-5721, July 2016 ([TR2016-041](#))

Berntorp, K.; Di Cairano, S., “**Particle Filtering for Online Motion Planning with Task Specifications**”, *American Control Conference (ACC)*, DOI: 10.1109/ACC.2016.7525232, pp. 2123-2128, July 2016 ([TR2016-052](#))

Walsh, A.; Di Cairano, S.; Weiss, A., “**MPC for Coupled Station Keeping, Attitude Control, and Momentum Management of Low-Thrust Geostationary Satellites**”, *American Control Conference (ACC)*, DOI: 10.1109/ACC.2016.7526842, pp. 7408-7413, July 2016 ([TR2016-047](#))

Burns, D.J.; Laughman, C.R.; Guay, M., “**Proportional-Integral Extremum Seeking for Vapor Compression Systems**”, *American Control Conference (ACC)*, DOI: 10.1109/ACC.2016.7525269, pp. 2352-2357, July 2016 ([TR2016-049](#))

Donglei, F.; Di Cairano, S., “**Further Results and Properties of Indirect Adaptive Model Predictive Control for Linear Systems with Polytopic Uncertainty**”, *American Control Conference (ACC)*, DOI: 10.1109/ACC.2016.7525367, pp. 2948-2953, July 2016 ([TR2016-044](#))

Bridgeman, L.; Danielson, C.; Di Cairano, S., “**Stability and Feasibility of MPC for Switched Linear Systems with Dwell-time Constraints**”, *American Control Conference (ACC)*, DOI: 10.1109/ACC.2016.7525323, pp. 2681-2686, July 2016 ([TR2016-045](#))

Di Cairano, S.; Goldsmith, A.M., “**Control of Dual-stage Processing Machines by Bounded Tracking-error MPC**”, *American Control Conference (ACC)*, DOI: 10.1109/ACC.2016.7525167, pp. 1735-1740, July 2016 ([TR2016-042](#))

Di Cairano, S., “**Indirect Adaptive Model Predictive Control for Linear Systems with Polytopic Uncertainty**”, *American Control Conference (ACC)*, DOI: 10.1109/ACC.2016.7525467, pp. 3570-3575, July 2016 ([TR2016-043](#))

Raghunathan, A.U.; Knyazev, A., “**Degeneracy in Maximal Clique Decomposition for Semidefinite Programs**”, *American Control Conference (ACC)*, DOI: 10.1109/ACC.2016.7526549, pp. 5605-5611, July 2016 ([TR2016-040](#))

Berntorp, K.; Grover, P., “**Data-Driven Gain Computation in the Feedback Particle Filter**”, *American Control Conference (ACC)*, DOI: 10.1109/ACC.2016.7525328, pp. 2711-2716, July 2016 ([TR2016-050](#))

Xu, J.; Nikovski, D.N., “**A Humidity Integrated Building Thermal Model**”, *American Control Conference (ACC)*, DOI: 10.1109/ACC.2016.7525127, pp. 1492-1499, July 2016 ([TR2016-053](#))

Guo, J.; Orlik, P.V.; Ishibashi, K., “**Resource Aware Hierarchical Routing in Heterogeneous Wireless IoT Networks**”, *IEEE International Conference on Ubiquitous and Future Networks*, DOI: 10.1109/ICUFN.2016.7537103, pp. 599-604, July 2016 ([TR2016-082](#))

Yoshida, T.; Kojima, K.; Koike-Akino, T.; Millar, D.S.; Dohi, K.; Matsuda, K.; Parsons, K.; Kubo, K.; Uto, K.; Sugihara, T., “**Crossover Block Modulation with Complementary Codes Superposition**”, *Opto Electronics and Communications Conference (OECC)*, July 2016 ([TR2016-081](#))

Fang, H.; Wang, Y., “**Health-Aware and User-Involved Battery Charging Management for Electric Vehicles: Linear Quadratic Strategies**”, *IEEE Transactions on Control Systems Technology*, DOI: 10.1109/TCST.2016.2574761, vol. 25, no. 3, pp. 911-923, July 2016 ([TR2016-063](#))

Benosman, M.; Farahmand, A.-M., “**Bayesian Optimization-based Modular Indirect Adaptive Control for a Class of Nonlinear Systems**”, *IFAC International Workshop on Adaptation and Learning in Control and Signal Processing*, DOI: 10.1016/j.ifacol.2016.07.960, vol. 49, no. 13, pp. 253-258, June 2016 ([TR2016-061](#))

Benosman, M., “**Extremum Seeking-based Parametric Identification for Partial Differential Equations**”, *IFAC Workshop on Control of Systems Governed by Partial Differential Equations*, DOI: 10.1016/j.ifacol.2016.07.412, vol. 49, no. 8, pp. 19-24, June 2016 ([TR2016-060](#))

Subbaraman, A.; Benosman, M., “**Extremum Seeking-based Iterative Learning Model Predictive Control**”, *IFAC International Workshop on Adaptation and Learning in Control and Signal Processing*, DOI: 10.1109/CCA.2014.6981582, pp. 1849-1854, June 2016 ([TR2016-058](#))

Kim, K.J.; Khan, T.; Orlik, P.V., “**Performance Analysis of Cooperative Systems with Unreliable Backhauls and Selection Combining**”, *IEEE Transactions on Vehicular Technology*, DOI: 10.1109/TVT.2016.2585347, vol. 66, no. 3, pp. 2448-2461, June 2016 ([TR2016-149](#))

Singh, B.; Marks, T.K.; Jones, M.J.; Tuzel, C.O., “**A Multi-Stream Bi-Directional Recurrent Neural Network for Fine-Grained Action Detection**”, *IEEE Conference on Computer Vision and Pattern Recognition (CVPR)*, DOI: 10.1109/CVPR.2016.216, pp. 1961-1970, June 2016 ([TR2016-080](#))

Vemulapalli, R.; Tuzel, C.O.; Liu, M.-Y., “**Deep Gaussian Conditional Random Field Network: A Model-based Deep Network for Discriminative Denoising**”, *IEEE Conference on Computer Vision and Pattern Recognition (CVPR)*, DOI: 10.1109/CVPR.2016.351, pp. 4801-4809, June 2016 ([TR2016-079](#))

Vemulapalli, R.; Tuzel, C.O.; Liu, M.-Y.; Chellappa, R., “**Gaussian Conditional Random Field Network for Semantic Segmentation**”, *IEEE Conference on Computer Vision and Pattern Recognition (CVPR)*, DOI: 10.1109/CVPR.2016.351, pp. 3224-3233, June 2016 ([TR2016-078](#))

Berntorp, K.; Di Cairano, S., “**Joint Decision Making and Motion Planning for Road Vehicles Using Particle Filtering**”, *IFAC Symposium Advances in Automotive Control*, DOI: 10.1016/j.ifacol.2016.08.027, vol. 49, no. 11, pp. 175-181, June 2016 ([TR2016-038](#))

Liu, C.; Wu, J.; Long, C.; Wang, Y., “**Dynamic State Recovery for Cyber-Physical Systems under Switching Location Attacks**”, *IEEE Transactions on Control of Networked Systems*, DOI: 10.1109/TCNS.2016.2580906, vol. 4, no. 1, pp. 14-22, June 2016 ([TR2016-104](#))

Zhang, Y.; Teo, K.H.; Palacios, T., “**GaN HEMTs with Multi-functional p-Diamond Back-barriers**”, *IEEE International Symposium on Power Semiconductor Devices (ISPSD)*, DOI: 10.1109/ISPSD.2016.7520789, pp. 107-110, June 2016 ([TR2016-069](#))

Wang, Y.; Wang, Y.-S.; Bortoff, S.A., “**On extension of a gradient-based co-design algorithm to linear descriptor systems**”, *World Congress on Intelligent Control and Automation (WCICA)*, DOI: 10.1109/WCICA.2016.7578834, pp. 2388-2393, June 2016 ([TR2016-076](#))

Liu, M.-Y.; Tuzel, O., “**Coupled Generative Adversarial Nets**”, *arXiv*, June 2016 ([TR2016-070](#))

Kamilov, U.; Liu, D.; Mansour, H.; Boufounos, P.T., “**A Recursive Born Approach to Nonlinear Inverse Scattering**”, *IEEE Signal Processing Letters*, DOI: 10.1109/LSP.2016.2579647, vol. 23, no. 8, pp. 1052-1056, August 2016 ([TR2016-057](#))

Wittenburg, K.B.; Turchi, T., “**Treemaps and the Visual Comparison of Hierarchical Multidimensional Data**”, *International Working Conference on Advanced Visual Interfaces (AVI)*, DOI: 10.1145/2909132.2909286, June 2016 ([TR2016-032](#))

Knyazev, A.; Malyshev, A., “**Accelerated Graph-based Nonlinear Denoising Filters**”, *International Conference on Computational Science (ICCS)*, DOI: 10.1016/j.procs.2016.05.348, vol. 80, pp. 607-616, June 2016 ([TR2016-068](#))

Kojima, K.; Koike-Akino, T.; Millar, D.S.; Yoshida, T.; Parsons, K., “**BICM capacity analysis of 8QAM-alternative 2D/4D modulation formats in nonlinear fiber transmission**”, *Conference on Lasers and Electro-Optics (CLEO)*, DOI: 10.1364/CLEO_SI.2016.SM2F.5, ISBN: 978-1-943580-11-8, June 2016 ([TR2016-067](#))

Mansour, H.; Tian, D.; Vetro, A., “**Factorized Robust Matrix Completion**”, *Robust Low-Rank and Sparse Matrix Decomposition: Applications in Image and Video Processing*, June 2016 ([TR2016-066](#))

Guay, M.; Burns, D.J., “**A proportional integral extremum-seeking control approach for discrete-time nonlinear systems**”, *International Journal of Control*, DOI: 10.1080/00207179.2016.1213425, May 2016 ([TR2016-065](#))

Benosman, M., “**Multi-Parametric Extremum Seeking-based Iterative Feedback Gains Tuning for Nonlinear Control**”, *International Journal of Robust and Nonlinear Control*, DOI: 10.1002/rnc.3547, vol. 26, no. 18, pp. 4035- 4055, May 2016 ([TR2016-059](#))

Tian, D.; Mansour, H.; Cohen, R.A.; Vetro, A., “**Graph Signal Processing for Scene Representation and Analysis**”, *Graph Signal Processing Workshop*, May 2016 ([TR2016-064](#))

Sullivan, A.; Brand, M.E., “**Rapid and accurate dose computation and optimization for IMPT**”, *Particle Theory Co-Operative Group*, May 2016 ([TR2016-071](#))

Fujihashi, T.; Koike-Akino, T.; Watanabe, T.; Orlik, P.V., “**Quality improvement and overhead reduction for soft video delivery**”, *IEEE International Conference on Communications (ICC)*, DOI: 10.1109/ICC.2016.7511548, pp. 1-6, May 2016 ([TR2016-077](#))

Yuan, W.; Ramalingam, S., “**Fast Localization and Tracking Using Event Sensors**”, *IEEE International Conference on Robotics and Automation (ICRA)*, DOI: 10.1109/ICRA.2016.7487657, pp. 4564-4571, May 2016 ([TR2016-033](#))

Pillai, S.; Ramalingam, S.; Leonard, J.J., “**High-Performance and Tunable Stereo Reconstruction**”, *IEEE International Conference on Robotics and Automation (ICRA)*, DOI: 10.1109/ICRA.2016.7487488, pp. 3188-3196, May 2016 ([TR2016-037](#))

Son, K.; Liu, M.-Y.; Taguchi, Y., “**Learning to Remove Multipath Distortions in Time-of-Flight Range Images for a Robotic Arm Setup**”, *IEEE International Conference on Robotics and Automation (ICRA)*, DOI: 10.1109/ICRA.2016.7487515, pp. 3390-3397, May 2016 ([TR2016-036](#))

Ataer-Cansizoglu, E.; Taguchi, Y.; Ramalingam, S., “**Pinpoint SLAM: A Hybrid of 2D and 3D Simultaneous Localization and Mapping for RGB-D Sensors**”, *IEEE International Conference on Robotics and Automation (ICRA)*, DOI: 10.1109/ICRA.2016.7487262, pp. 1300-1307, May 2016 ([TR2016-035](#))

Zhang, Y.; Teo, K.H.; Palacios, T., **“Beyond Thermal Management: Incorporating p-Diamond Back-barriers and Cap-layers into AlGaIn/GaN HEMTs”**, *IEEE Transactions on Electron Devices*, DOI: 10.1109/TED.2016.2553136, vol. 63, no. 6, pp. 2340 - 2345, April 2016 ([TR2016-117](#))

Zhou, L.; Wang, Y.; Trumper, D., **“Iterative Tuning Feedforward Speed Estimator for Sensorless Induction Motors”**, *Spring Topical Meeting Precision Mechatronic System Design and Control*, April 2016 ([TR2016-030](#))

Research

The body and soul of any research lab is its portfolio of research projects. Therefore it is appropriate that the main body of this annual report consists of descriptions of research projects being done at MERL. The reports are grouped into six topic areas corresponding to MERL's six research groups.

Business Innovation – Exploration of potential new areas of business for Mitsubishi Electric, with a particular focus on potential in the United States that combines the efforts of multiple business units. Research on whole-systems multi-physical simulation as a basis for producing more fully optimized products in less time.

Electronics & Communications - wireless and optical communications, advanced signal processing, optical and semiconductor devices, and electro-magnetics, with application to product areas such as terrestrial and trans-oceanic optical networks, train and automotive connectivity and electronics, power equipment and systems for smart grid, RF power amplifiers & front-end modules, and wireless charging, thermal and electrical conductivity manipulation.

Multimedia – Acquisition, representation, processing and security of multimedia, as well as enhanced interaction with multimedia. Core technical strengths are in various aspects of signal processing ranging from video and speech processing, to information forensics and security, as well as signal processing theory and sensing methods.

Data Analytics – Innovative high-performance algorithms that can be applied to electrical power systems, various transportation systems (trains, elevators, car navigation), heating, ventilation, and air conditioning (HVAC) systems and solutions, and factory automation. The application of these algorithms minimizes costs, increases reliability, improves energy efficiency, and reduces environmental impact of products.

Computer Vision - Processing data from across space and time to extract meaning and build representations of objects and events in the world. Detection, classification, and recognition based on machine learning and physical modeling; 3D reconstruction, location, and inference; computational imaging for optimized information capture; Dictionary Learning for signal processing; tracking; and multi-modal sensor integration.

Mechatronics - If it moves, we control it: Advanced control algorithms, model predictive control, nonlinear dynamical systems, system-level dynamic modeling and analysis, mechatronic co-design, thermo-fluid system dynamics, and applications to factory automation, elevators, space systems, automotive mechatronics, and HVAC.

Algorithms - Solution methods for optimization problems involving very large numbers of variables or real-time computing in the areas of control, data mining, signal processing and optics.

Electronics & Communications

The Electronics & Communications Group conducts fundamental and applied research in the areas of wireless and optical communications, advanced signal processing, optical and semiconductor devices, and electro-magnetics. Our research has application to product areas such as terrestrial and trans-oceanic optical networks, train and automotive connectivity, mobile cellular, power equipment and systems for IoT, RF power amplifiers and front-end modules, non-contact sensing, and thermal and electrical conductivity manipulation.

Wireless research focuses on the development of novel physical and network layer algorithms, combined with advanced signal processing, to enable high reliability wireless networks for IoT networks, 5G/millimeter wave systems and vehicular networks. Our signal processing work involves detection, localization and applied optimization algorithms for applications such as IoT.

Optical research focuses on transceiver signal processing algorithms and error control coding for coherent long haul and sub-sea fiber-optic communications, and the development of novel photonic integrated circuits to support coherent optical communications applications.

Power & RF work emphasizes highly efficient wideband power amplifier technology and semiconductor devices, as well as electro-magnetic analysis and manipulation, for applications such as non-contact sensing and material design for thermal and electrical conductivity.

Recent Research

On ... Data Association for Achieving Near-Exponential Diversity over Fading Channels	46
Bit-Interleaved Polar-Coded Modulation for Low-Latency Short-Block Transmission	46
Resource Aware Hierarchical Routing in Heterogeneous Wireless IoT Networks	47
Nonlinearity-tolerant four-dimensional 2A8PSK family for 5-7 bits/symbol spectral efficiency	47
Outphasing Multi-Level RF PWM for Inter-Band Carrier Aggregation in Digital Transmitters.	48
Millimeter Wave Communications Channel Estimation via Bayesian Group Sparse Recovery .	48
Thermal Emitter Design based on Gap and Spacer Plasmon Mode Coupling	49
An Accurate Contactless Position Sensor with Planar Resonators.....	49
MMI-Based Polarization Beam Splitter/Combiner for InP Photonic Integrated Circuits	50
Application of Numerical Optimization to the Design of InP-based Wavelength Combiners.....	50
A Simplified Dual-Carrier DP-64QAM 1 Tb/s Transceiver.....	51
An Unsupervised Indoor Localization Method Based on Received Signal Strength (RSS)	51
Design of Broadband Three-way Sequential Power Amplifiers.....	52
... Incorporating p-Diamond Back-barriers and Cap-layers into AlGaIn/GaN HEMTs	52

On Probabilistic Data Association for Achieving Near-Exponential Diversity over Fading Channels

Citation: Yellepeddi, A.; Kim, K.J.; Duan, C.; Orlik, P.V., "On Probabilistic Data Association for Achieving Near-Exponential Diversity over Fading Channels", *IEEE International Conference on Communications (ICC)*, DOI: 10.2209/icc.2013.6655449, ISSN: 1550-3607, pp. 5409-5414, June 2013

Contacts: Kyeong Jin Kim, Philip V. Orlik

Machine-to-Machine (M2M) wireless communication requires the transmission of short blocks of data with high reliability over fading channels. We discuss the use of the probabilistic data association (PDA) detector in conjunction with precoding to design high-performance systems for these links. First, the performance of the traditional PDA algorithm with precoding over ideal Rayleigh fading links is analyzed, which provides insight into its performance, and evidence of an error floor at high SNRs. Then, a novel ordering mechanism is proposed that takes advantage of the precoder characteristics. It is shown by simulation that the proposed modified algorithm can achieve near-ML performance for block sizes as small as 32 symbols.

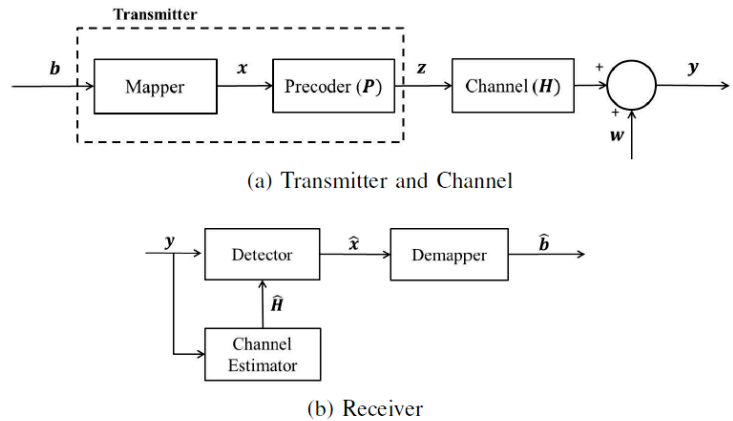

Fig. 1: Block diagram of the considered system.

Bit-Interleaved Polar-Coded Modulation for Low-Latency Short-Block Transmission

Citation: Koike-Akino, T.; Wang, Y.; Draper, S.C.; Sugihara, K.; Matsumoto, W.; Millar, D.S.; Parsons, K.; Kojima, K., "Bit-Interleaved Polar-Coded Modulation for Low-Latency Short-Block Transmission", *Optical Fiber Communication Conference and Exposition and the National Fiber Optic Engineers Conference (OFC/NFOEC)*, March 8, 2017.

Contacts: Toshiaki Koike-Akino, Ye Wang

We show that polar codes with list+CRC decoding can outperform state-of-the-art LDPC codes in short block lengths. In addition, we introduce an efficient interleaver for polar-coded high-order modulations, achieving greater than 0.5 dB gain for 256QAM.

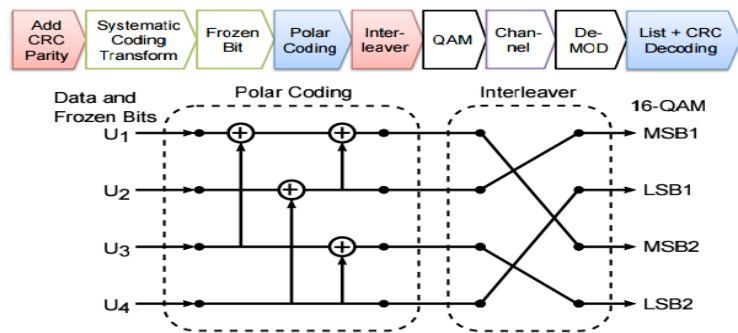

Resource Aware Hierarchical Routing in Heterogeneous Wireless IoT Networks

Citation: Guo, J.; Orlik, P.V.; Ishibashi, K., "Resource Aware Hierarchical Routing in Heterogeneous Wireless IoT Networks", *IEEE International Conference on Ubiquitous and Future Networks*, p. 599- 604, July 5, 2016.

Contacts: Jianlin Guo, Philip V. Orlik

Routing algorithms consume the resources of the network nodes. Different routing algorithms require different amount of the resources. Nodes at different positions of the network topology require different amount of the resources. Routing algorithms must adapt to both available resources and required resources of the nodes. The IPv6 Routing Protocol for Low-Power and Lossy Networks (RPL) considers memory and defines four modes of operation (MOPs). However, RPL allows only one MOP for all routers in a network. This paper presents a resource aware hierarchical RPL (H-RPL) to realize the mixed MOPs and the resource adaptation in heterogeneous wireless IoT networks. Taking routing preferences of the nodes into account, H-RPL also applies heterogeneous routing metrics and objective functions in hierarchical network topology construction. Simulation results show that H-RPL can improve upward data packet delivery rate by 7%, downward data packet delivery rate by 25% and extend network lifetime by 78%.

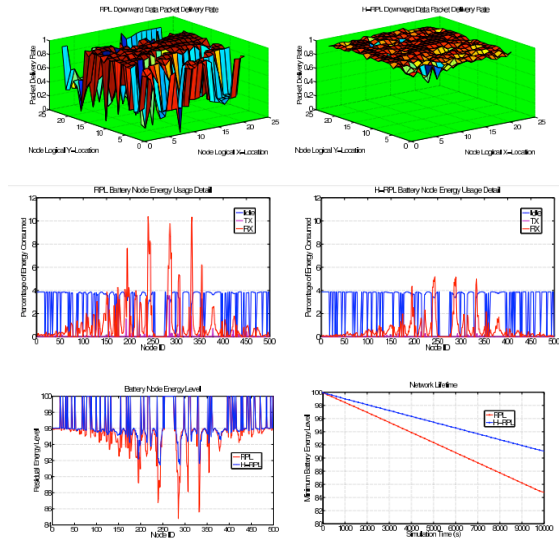

Nonlinearity-tolerant four-dimensional 2A8PSK family for 5-7 bits/symbol spectral efficiency

Citation: Kojima, K.; Yoshida, T.; Koike-Akino, T.; Millar, D.S.; Parsons, K.; Arlunno, V., "Nonlinearity-tolerant four-dimensional 2A8PSK family for 5-7 bits/symbol spectral efficiency", *IEEE Journal of Lightwave Technology*, vol. 35, no. 8, p. 1383- 1391, March 31, 2017.

Contacts: Keisuke Kojima, Toshiaki Koike-Akino, David S. Millar, Kieran Parsons

We describe in detail the recently proposed four-dimensional modulation format family based on 2-ary amplitude 8-ary phase-shift keying (2A8PSK), supporting spectral efficiencies of 5, 6, and 7 bits/symbol. These formats nicely fill the spectral efficiency gap between dual-polarization quadrature PSK (DP-QPSK) and DP 16-ary quadrature-amplitude modulation (DP-16QAM), with excellent linear and nonlinear performance. Since these modulation formats merely use different parity bit expressions in the constellation, similar digital signal processing can be seamlessly used for different spectral efficiency.

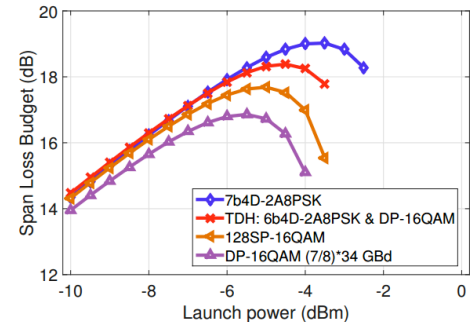

Outphasing Multi-Level RF PWM for Inter-Band Carrier Aggregation in Digital Transmitters

Citation: Chung, S., Ma, R., Teo, K.H., Parsons, K., "Outphasing Multi-Level RF PWM Signals for Inter-Band Carrier Aggregation in Digital Transmitters", *IEEE Radio Wireless Week (RWW)*, January 2015.

Contacts: Rui Ma, Koon Hoo Teo, Kieran Parsons

A novel non-contiguous concurrent multiband digital-RF transmitter architecture is presented, which is based on outphasing the multi-level RF pulse-width modulated signals (MLRF-PWM) for digital Class-S power amplifiers. To improve the transmitter power efficiency, the outphasing modulation in the proposed architecture effectively increases the number of MLRF-PWM signal output levels. In addition, a multi-band multibit band-pass delta-sigma modulator (BPDSM) with a hard clipping technique is introduced, which further improves power coding efficiency by trading off distortion performance with coding efficiency. Experimental results with a dual-channel 25-GSPS arbitrary waveform generator (AWG) demonstrate non-contiguous carrier aggregation for 3-level Class-S PAs with inter-band LTE signals at 874 MHz and 1501 MHz for the channel bandwidth of 10-MHz and 20-MHz, respectively. The proposed outphasing MLRF-PWM technique achieves 59.5% power coding efficiency, which is significant improvement from the 8.6% coding efficiency of conventional 3-level BPDSM with the experimental dual band LTE signal transmission.

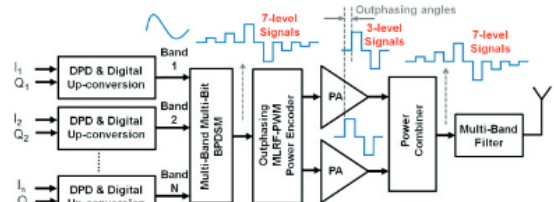

Fig. 2. Proposed outphasing multi-level RF-PWM (MLRF-PWM) transmitter architecture for inter-band CA.

Millimeter Wave Communications Channel Estimation via Bayesian Group Sparse Recovery

Citation: Suryaprakash, R.T.; Pajovic, M.; Kim, K.J.; Orlik, P.V., "Millimeter Wave Communications Channel Estimation via Bayesian Group Sparse Recovery", *IEEE International Conference on Acoustics, Speech and Signal Processing (ICASSP)*, DOI: 10.1109/ICASSP.2016.7472309, pp. 3406-3410, March 2016.

Contacts: Milutin Pajovic, Kyeong Jin Kim, Philip V. Orlik

We consider the problem of channel estimation for millimeter wave communications (mmWave). We formulate channel estimation as a structured sparse signal recovery problem, in which the signal structure is governed by a priori knowledge of the channel characteristics. We develop a Bayesian group sparse recovery algorithm, which takes into account several features unique to mmWave channels, such as spatial (angular) spreads of received signals and power profile of rays impinging on the receiver array.

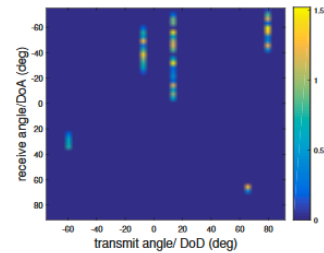

Fig. 1. Plot of $|H_s|$ (single realization). Rows correspond to DoD and columns to DoA. Rays arrive clustered spatially at the receiver, so that non-zero components are group sparse.

Thermal Emitter Design based on Gap and Spacer Plasmon Mode Coupling

Citation: Wang, J.; Wang, B.; Lin, C.; Teo, K.H., "Thermal Emitter Design based on Gap and Spacer Plasmon Mode Coupling", *OSA Light, Energy and the Environment Congress*, November 14, 2016.

Contacts: Bingnan Wang, Chungwei Lin, Koon Hoo Teo

Thermal emitters, which are devices to convert heat into radiation, are essential in many applications, including thermal imaging, sensing, and energy conversion in thermophotovoltaic

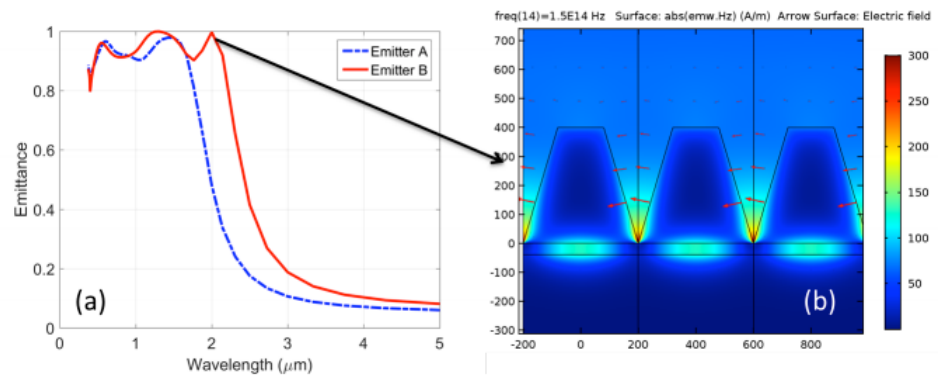

(TPV) systems. The design of thermal emitters is actively pursued in order to offer more flexible control over the directional and spectral properties of thermal radiation, and to fit the needs of those applications. In particular, the thermal emitter is a key component on a TPV system, which converts heat into electric energy via a photovoltaic cell [1]. We propose tungsten based thermal emitters. With a simple three-layer metal-dielectric-metal design. We obtain over 0.9 emittance between 0.5 and 2.2 μm, which is achieved by strong coupling between gap and spacer plasmon resonances.

An Accurate Contactless Position Sensor with Planar Resonators

Citation: Wang, B.; Teo, K.H.; Orlik, P.V., "An Accurate Contactless Position Sensor with Planar Resonators", *IEEE Sensors 2016*, DOI: 10.1109/ICSENS.2016.7808939, November 2, 2016.

Contacts: Bingnan Wang, Koon Hoo Teo, Philip V. Orlik

In this paper, we report the development of a contactless position sensor with thin and planar structures for both sensor and target. The target is designed to be a compact resonator with resonance near the operating frequency, which improves the signal strength and increases the sensing range. The sensor is composed of a source coil and a pair of symmetrically arranged detecting coils. With differential measurement technique, highly accurate edge detection can be realized. Experiment results show that the sensor operates at varying gap size between the target and the sensor, even when the target is at 30 mm away, and the achieved accuracy is within 2% of the size of the sensing coil.

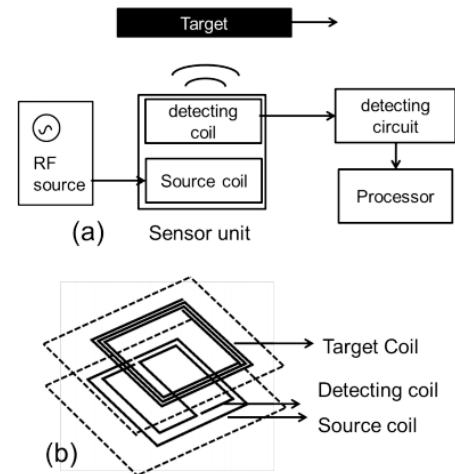

MMI-Based Polarization Beam Splitter/Combiner for InP Photonic Integrated Circuits

Citation: Felicetti, M.; Kojima, K.; Koike-Akino, T.; Wang, B.; Parsons, K.; Nishikawa, S.; Yagyu, E., "MMI-Based Polarization Beam Splitter/Combiner for InP Photonic Integrated Circuits", *Integrated Photonics Research, Silicon and Nano Photonics (IPR)*, DOI: 10.1364/IPRSN.2015.IM2A.5, ISBN: 978-1-55752-0005, July 2015.

Contacts: Keisuke Kojima, Toshiaki Koike-Akino, Bingnan Wang, Kieran Parsons

An MMI-based polarization splitter/combiner with a TE-TM splitting ratio above 15 dB over a 21 nm wavelength range is demonstrated. The compact device is integrated in a photonic circuit within an InP multi-project wafer run.

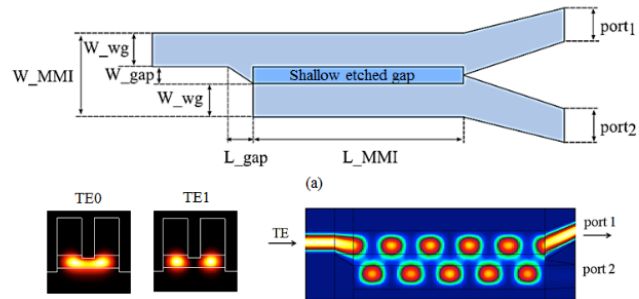

Application of Numerical Optimization to the Design of InP-based Wavelength Combiners

Citation: Ozbayat, S., Kojima, K., Koike-Akino, T., Wang, B., Parsons, K., Singh, S., Nishikawa, S., Yagyu, E., "Application of Numerical Optimization to the Design of InP-based Wavelength Combiners", *Optics Communications*, DOI: 10.1016/j.optcom.2014.02.030, ISSN: 0030-4018, Vol. 322, pp. 131-136, July 2014.

Contacts: Keisuke Kojima, Toshiaki Koike-Akino, Bingnan Wang, Kieran Parsons

We applied a numerical device optimization scheme, where tens of parameters can be optimized simultaneously with multiple target performance criteria that are given. The key items of the design scheme are the selection of the best optimization algorithm, metric, and consideration for fabrication errors.

This method was then applied to design an MMI beam combiner with rectangular effective refractive steps with up to 75 parameters, and we obtained a simulated insertion loss of 0.8 dB for a 1.4 mm-long 2x1 wavelength combiner, and a simulated insertion loss of 4.2 dB for a 1.9 mm-long 4x1 wavelength combiner, both with 20 nm wavelength spacing.

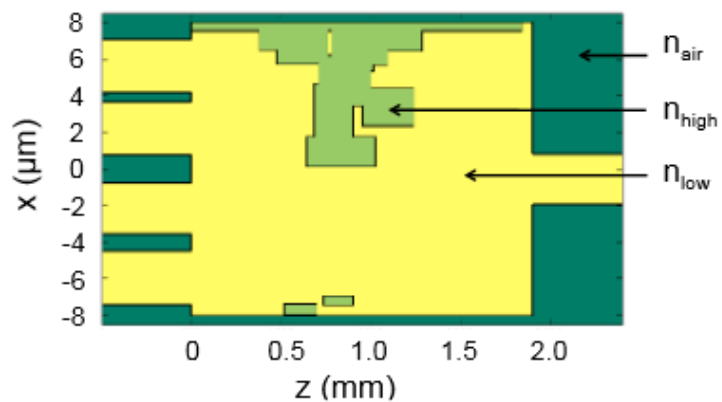

A Simplified Dual-Carrier DP-64QAM 1 Tb/s Transceiver

Citation: Millar, D.S.; Pajovic, M.; Koike-Akino, T.; Kojima, K.; Parsons, K., "A Simplified Dual-Carrier DP-64QAM 1 Tb/s Transceiver", *Optical Fiber Communication Conference and Exposition (OFC)*, DOI: 10.1364/OFC.2017.M3D.2, March 19, 2017.

Contacts: David S. Millar, Milutin Pajovic, Toshiaki Koike-Akino, Keisuke Kojima, , Kieran Parsons

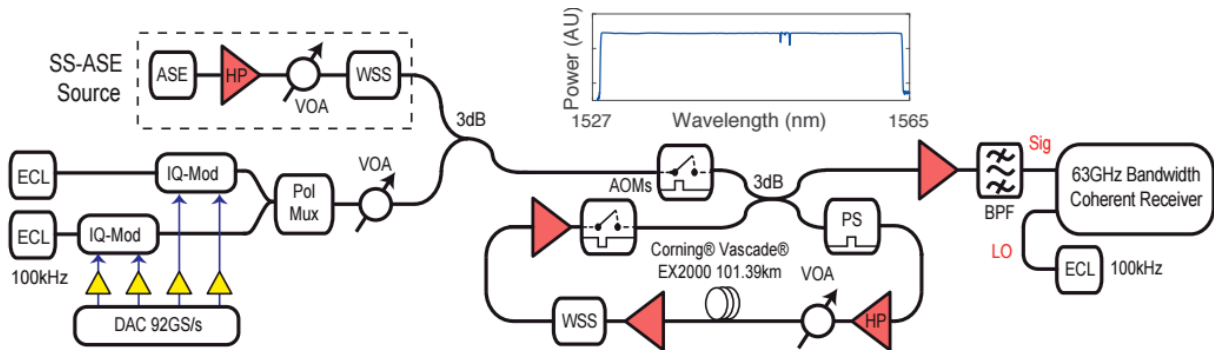

A 1 Tb/s net bitrate transceiver using a low complexity dual-carrier architecture with free running lasers and DP-64QAM, enabled by pilot-aided DSP and low-rate LDPC, is shown to achieve transmission over 400 km with 100 km amplifier spacing.

An Unsupervised Indoor Localization Method Based on Received Signal Strength (RSS)

Citation: Pajovic, M.; Orlik, P.V.; Koike-Akino, T.; Kim, K.J.; Aikawa, H.; Hori, T., "An Unsupervised Indoor Localization Method Based on Received Signal Strength (RSS) Measurements", *IEEE Global Communications Conference (GLOBECOM)*, DOI: 10.1109/GLOCOM.2015.7417708, pp.1-6, December 2015.

Contacts: Milutin Pajovic, Philip V. Orlik, Toshiaki Koike-Akino, Kyeong Jin Kim, Takaaki Hori

We propose an unsupervised, received signal strength (RSS)-based indoor localization method, which as an infrastructure uses commercial WiFi chipsets and does not require any changes in the existing hardware. The method relies on path loss model for measured RSS levels where path loss coefficient is treated as a discrete random variable which takes values from some finite alphabet. The unknown location and path loss coefficient corresponding to each access point are jointly estimated using the Expectation Maximization (EM) approach. The algorithm is experimentally tested in an office space area of dimensions 32-by-52 m (1600 m²) with only five access points and the achieved average localization error is below 4.5 m.

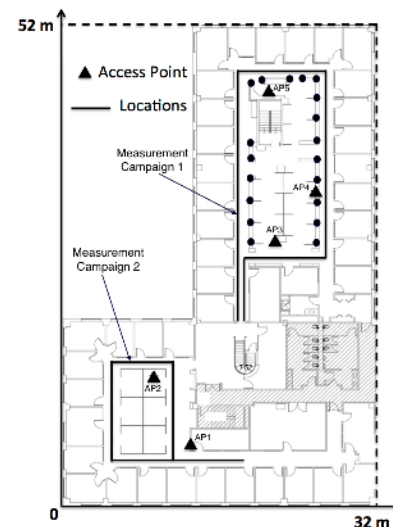

Design of Broadband Three-way Sequential Power Amplifiers

Citation: Ma, R.; Shao, J.; Shinjo, S.; Teo, K.H., "Design of Broadband Three-way Sequential Power Amplifiers", *2016 IEEE International Symposium on Radio-Frequency Integration Technology (RFIT)*, DOI: 10.1109/RFIT.2016.7578196, August 24, 2016.

Contacts: Rui Ma, Koon Hoo Teo

In this paper, we report a fully analog three-way sequential power amplifiers (SPA) using 10W GaN HEMTs. The proposed three-way SPA delivers P_{sat} of 39~40 dBm over 2.45-2.8 GHz covering a 15.4% fractional bandwidth. The three-way SPA includes a 2:1:1 multi-way splitter, a carrier amplifier, two peaking amplifiers, and a 7:1.5:1.5 combiner for power combining. The measured three-way SPA shows 41% to 44% drain efficiency (DE) at 31 dBm (9 dB backoff) output from 2.5 to 2.8 GHz under CW stimulus. To the best of the authors' knowledge, the proposed three-way SPA is the first time reported three-way SPA in literature.

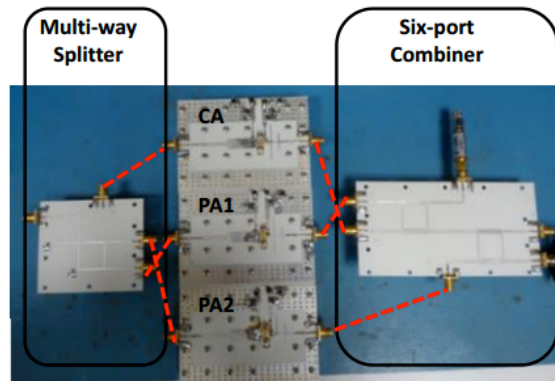

More than Thermal Management: Incorporating p-Diamond Back-barriers and Cap-layers into AlGaIn/GaN HEMTs

Citation: Zhang, Y.; Teo, K.H.; Palacios, T., "More than Thermal Management: Incorporating p-Diamond Back-barriers and Cap-layers into AlGaIn/GaN HEMTs", *IEEE Transactions on Electron Devices*, Vol. 63, no. 6, p. 2340-2345, DOI: 10.1109/TED.2016.2553136, September 30, 2016.

Contacts: Koon Hoo Teo

This work explores the use of p-diamond back-barriers and cap-layers to enhance the performance of GaN-based high electron mobility transistors (HEMTs). Diamond can offer a heavily-doped p-type layer, which is complementary to GaN

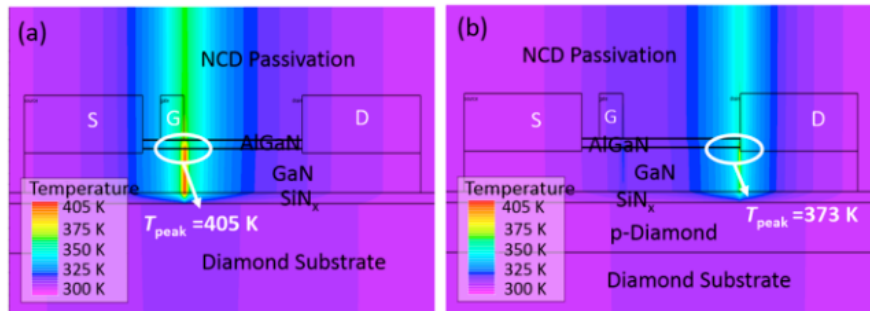

electronics. Self-consistent electro-thermal simulations reveal that the use of p-diamond back-barriers and cap-layers can increase the breakdown voltage of GaN-based HEMTs four-fold, at the same time that they enhance the 2DEG confinement and reduce short channel effects. These results highlight that p-diamond layers can improve the performance of GaN HEMTs for high-power and high-frequency applications beyond the thermal improvements pursued until now.

Multimedia

Multimedia research at MERL addresses the acquisition, representation, processing and privacy of multiple data modalities. Core technical strengths are in various aspects of signal processing ranging from video and speech processing to information security and sensing methods.

- The current thrust of our digital video work is on advanced compression technologies for 3D point clouds and remotely sensed imagery, as well as advanced visual analysis including analysis of human activity and motion flows.
- The speech and audio team pursue a range of challenging machine-perception problems involving acoustic signals, human language and everything in between. The research covers source separation and novel deep learning methods for acoustic and language modelling, as well as natural language understanding.
- Research on computational sensing exploits widely available computational power to overhaul the signal acquisition paradigm and significantly enhance sensing capabilities. Our research aims to fundamentally understand how signals behave and propagate in the environment, and develops reconstruction algorithms to recover these signals.
- Our information security research develops technologies to perform statistical inference under constraints, providing a computationally inexpensive method for data analysis while assuring strong statistical guarantees of security via anonymization of the data.

Our research results are applied to a wide range of products including automotive electronics and home appliances; surveillance and building management systems; space/airborne systems for remote sensing; and information technology systems.

Recent Research

Single-Channel Multi-Speaker Separation using Deep Clustering.....	54
Dialog State Tracking with Attention-based Sequence-to-sequence Learning	54
Attention-Based Multimodal Fusion for Video Description	55
Deep Long Short-Term Memory ... for Multichannel Robust Speech Recognition.....	55
Joint CTC- Attention Based End-to-End Speech Recognition Using Multi-task Learning	56
Learning-based Reduced Order Model Stabilization for Partial Differential Equations:	56
A Recursive Born Approach to Nonlinear Inverse Scattering.....	57
Coherent Distributed Array Imaging under Unknown Position Perturbations.....	57
Online Blind Deconvolution for Sequential Through-the-Wall-Radar-Imaging.....	58
Motion-Adaptive Depth Super-Resolution.....	58
Attribute compression for sparse point clouds using graph transforms.....	59
Contour-Enhanced Resampling of 3D Point Clouds Via Graphs.....	59
Disc-Glasso: Discriminative Graph Learning with Sparsity Regularization.....	60
On Methods for Privacy-Preserving Energy Disaggregation	60

Single-Channel Multi-Speaker Separation using Deep Clustering

Citation: Isik, Y.; Le Roux, J.; Chen, Z.; Watanabe, S.; Hershey, J.R., "Single-Channel Multi-Speaker Separation using Deep Clustering", *Interspeech*, September 8, 2016.

Contacts: Jonathan Le Roux, John R. Hershey, Shinji Watanabe

Deep clustering is a recently introduced deep learning architecture that uses discriminatively trained embeddings as the basis for clustering. It was recently applied to spectrogram segmentation, resulting in impressive results on speaker-independent multi-speaker separation. In this paper we extend the baseline system with an end-to-end signal approximation objective that greatly improves performance on a challenging speech separation. The new signal approximation objective, combined with end-to-end training, produces unprecedented performance, reducing the word error rate (WER) from 89.1% down to 30.8%. This represents a major advancement towards solving the cocktail party problem.

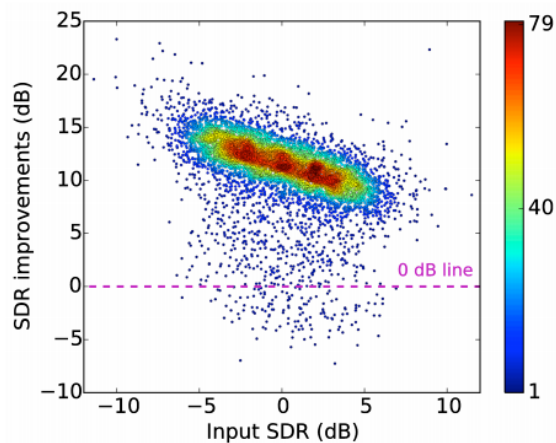

Dialog State Tracking with Attention-based Sequence-to-sequence Learning

Citation: Hori, T.; Wang, H.; Hori, C.; Watanabe, S.; Harsham, B.A.; Le Roux, J.; Hershey, J.R.; Koji, Y.; Jing, Y.; Zhu, Z.; Aikawa, T., "Dialog State Tracking with Attention-based Sequence-to-sequence Learning", *IEEE Workshop on Spoken Language Technology (SLT)*, DOI: 10.1109/SLT.2016.7846317, pp. 552 – 558, December 2016.

Contacts: Takaaki Hori, Chiori Hori, Brett A. Harsham, Jonathan Le Roux, Shinji Watanabe John R. Hershey

We present an advanced dialog state tracking system designed for the 5th Dialog State Tracking Challenge (DSTC5). For each utterance, the tracker emits a frame of slot-value pairs considering the full history of the dialog up to the current turn. Our system includes an encoder/decoder architecture with an attention mechanism to map an input word sequence to a set of semantic labels, i.e., slot-value pairs. This handles the problem of the unknown alignment between the utterances and the labels. By combining the attention-based tracker with rule-based trackers elaborated for English and Chinese, the F-score for the development set improved from 0.475 to 0.507 compared to the rule-only trackers.

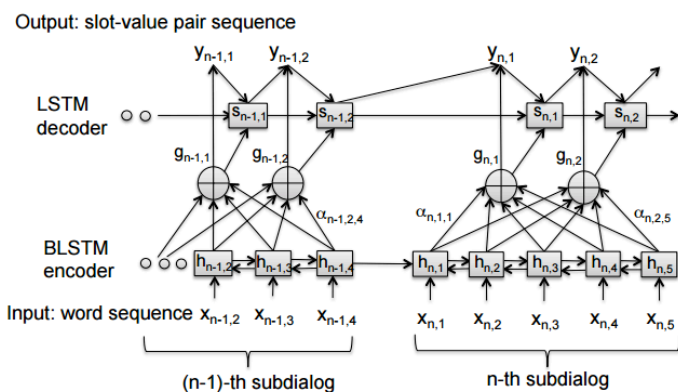

Attention-Based Multimodal Fusion for Video Description

Citation: Hori, C.; Hori, T.; Lee, T.-Y.; Sumi, K.; Hershey, J.R.; Marks, T.K., “Attention-Based Multimodal Fusion for Video Description”, *Submitted to CVPR*, January 2017.

Contacts: Chiori Hori, Takaaki Hori, Teng-Yok Lee, John R. Hershey, Tim K. Marks

Currently successful methods for video description are based on encoder/decoder sentence generation using recurrent neural networks (RNNs). Recent work has shown the advantage of integrating temporal and/or spatial attention mechanisms into these models, in which the decoder network predicts each word in the description by selectively giving more weight to encoded features from specific time frames (temporal attention) or to features from specific spatial regions (spatial attention). In this paper, we propose to expand the attention model to selectively attend not just to specific times or spatial regions, but to specific modalities of input such as image features, motion features, and audio features.

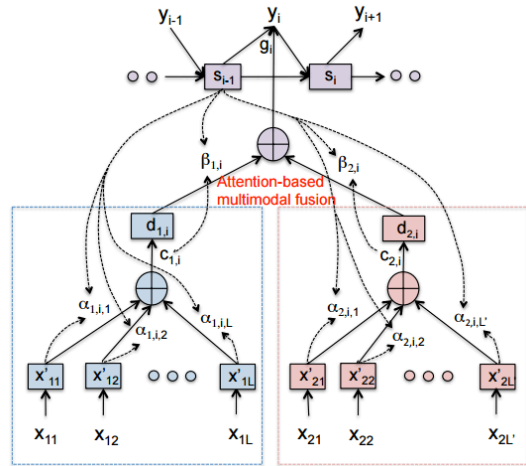

Our new modality-dependent attention mechanism, which we call multimodal attention, provides a natural way to fuse multimodal information for video description.

Deep Long Short-Term Memory Adaptive Beamforming Networks for Multichannel Robust Speech Recognition

Citation: Meng, Z.; Watanabe, S.; Hershey, J.R.; Erdogan, H., “Deep Long Short-Term Memory Adaptive Beamforming Networks for Multichannel Robust Speech Recognition”, *IEEE International Conference on Acoustics, Speech, and Signal Processing (ICASSP)*, March 2017.

Contacts: Shinji Watanabe, John R. Hershey

Far-field speech recognition in noisy and reverberant conditions is commonly addressed by acquiring a speech signal from multiple microphones and performing beamforming over them. In this paper, we propose to use a recurrent neural network with long short-term memory (LSTM) architecture to adaptively estimate real-time beamforming filter coefficients to cope with non-stationary environmental noise and the dynamic nature of source and microphone positions that results in a set of time-varying room impulse responses. The proposed system achieves 7.97% absolute gain over baseline systems with no beamforming on CHiME-3 real evaluation set.

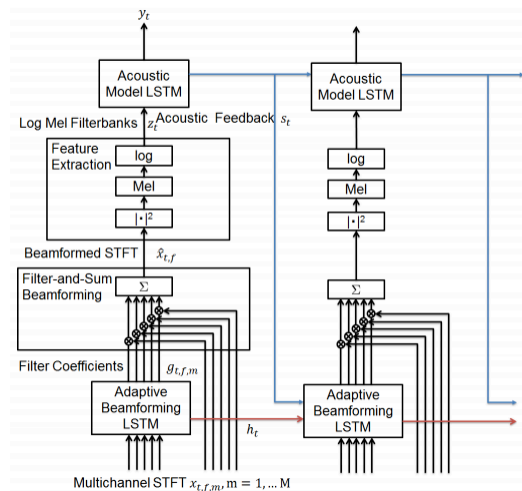

Joint CTC- Attention Based End-to-End Speech Recognition Using Multi-task Learning

Citation: Kim, S.; Hori, T.; Watanabe, S., “Joint CTC- Attention Based End-to-End Speech Recognition Using Multi-task Learning”, *IEEE International Conference on Acoustics, Speech, and Signal Processing (ICASSP)*, March 2017.

Contacts: Takaaki Hori, Shinji Watanabe

Recently, there has been an increasing interest in end-to-end speech recognition that directly transcribes speech to text without any predefined alignments. One approach is the attention-based encoder/decoder framework that learns a mapping between variable-length input and output sequences in one step using a purely data-driven method. The attention model has often been shown to improve the performance over another end-to-end approach, the Connectionist Temporal Classification (CTC), mainly because it explicitly uses the history of the target character without any conditional independence assumptions. However, we observed that the performance of the attention model severely degraded especially in noisy condition and is hard to learn in the initial training stage with long input sequences, as compared with CTC. This is because the attention model is too flexible to predict proper alignments in such cases due to the lack of left-to-right constraints as used in CTC. This paper presents a novel method for end-to-end speech recognition to improve robustness and achieve fast convergence by using a joint CTC-attention model within the multi-task learning framework, thereby mitigating the alignment issue.

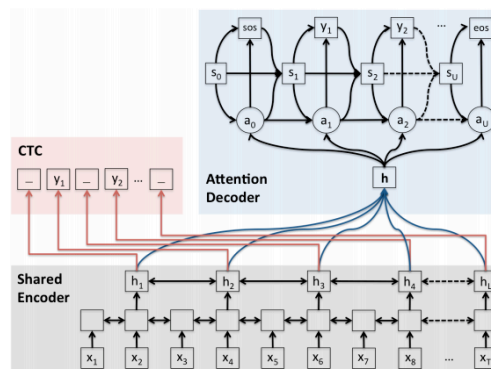

Learning-based Reduced Order Model Stabilization for Partial Differential Equations: Application to the Coupled Burgers' Equation

Citation: Benosman, M.; Boufounos, P.T.; Grover, P.; Kramer, B., “Learning-based Reduced Order Model Stabilization for Partial Differential Equations: Application to the Coupled Burgers' Equation”, *American Control Conference (ACC)*, DOI: 10.1109/ACC.2016.7525157, pp. 1673 – 1678, July 2016.

Contacts: Mouhacine Benosman, Petros T. Boufounos, Piyush Grover

We present results on stabilization for reduced order models (ROM) of partial differential equations using learning. Stabilization is achieved via closure models for ROMs, where we use a model-free extremum seeking (ES) dither-based algorithm to optimally learn the closure models' parameters. We first propose to auto-tune linear closure models using ES, and then extend the results to a closure model combining linear and nonlinear terms, for better stabilization performance. The coupled Burgers' equation is employed as a test for the proposed tuning method.

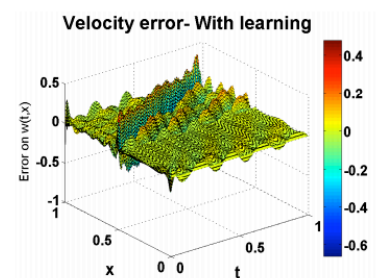

(a) Error between the true velocity and the learning-based POD ROM velocity profile

A Recursive Born Approach to Nonlinear Inverse Scattering

Citation: Kamilov, U.; Liu, D.; Mansour, H.; Boufounos, P.T., “A Recursive Born Approach to Nonlinear Inverse Scattering”, *IEEE Signal Processing Letters*, DOI: 10.1109/LSP.2016.2579647, vol. 23, no. 8, pp. 1052-1056, August 2016.
 Contacts: Ulugbek S. Kamilov, Dehong Liu, Hassan Mansour, Petros T. Boufounos

The Iterative Born Approximation (IBA) is a well-known method for describing waves scattered by semitransparent objects. In this letter, we present a novel nonlinear inverse scattering method that combines IBA with an edgepreserving total variation (TV) regularizer. The proposed method is obtained by relating iterations of IBA to layers of an artificial multi-layer neural network and developing a corresponding error backpropagation algorithm for efficiently estimating the permittivity of the object. Simulations illustrate that, by accounting for multiple scattering, the method successfully recovers the permittivity distribution where the traditional linear inverse scattering fails.

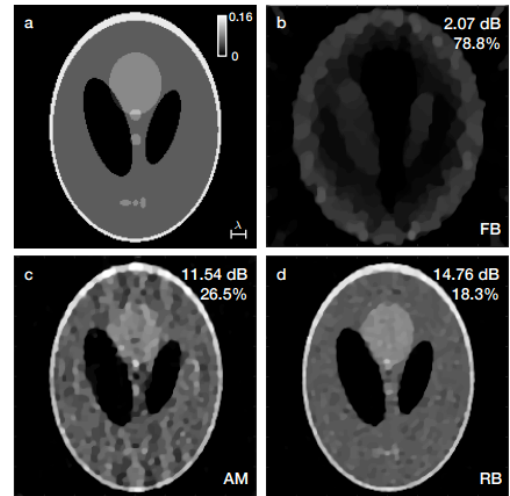

Coherent Distributed Array Imaging under Unknown Position Perturbations

Citation: Liu, D.; Kamilov, U.; Boufounos, P.T., “Coherent Distributed Array Imaging under Unknown Position Perturbations”, *International Workshop on Compressed Sensing Theory and its Applications to Radar, Sonar, and Remote Sensing (CoSeRa)*, DOI: 10.1109/CoSeRa.2016.7745709, pp. 105-109, September 2016.
 Contacts: Dehong Liu, Ulugbek Kamilov, Petros T. Boufounos

We consider a distributed array imaging problem for detecting targets in a region of interest (ROI), where the radar sensors are perturbed with location errors corresponding to several wavelengths. In order to improve the imaging performance, we propose a method based on compressive sensing that can simultaneously compensate for position-induced phase errors and perform focused imaging. Compared to existing autofocus methods that typically exhibit poor performance for large position errors, our method can form sharp images of targets situated in the ROI even for position errors that are ten wavelengths large. We validate our method on simulated noisy data.

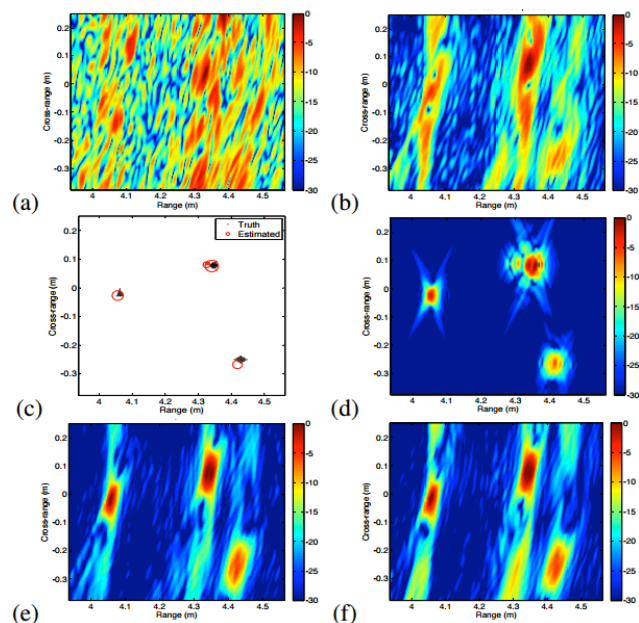

Online Blind Deconvolution for Sequential Through-the-Wall-Radar-Imaging

Citation: Mansour, H.; Kamilov, U.; Liu, D.; Orlik, P.V.; Boufounos, P.T.; Parsons, K.; Vetro, A., “Online Blind Deconvolution for Sequential Through-the-Wall-Radar-Imaging”, *International Workshop on Compressed Sensing Theory and its Applications to Radar, Sonar, and Remote Sensing (CoSeRa)*, DOI: 10.1109/CoSeRa.2016.7745700, pp.61- 65, September 2016.

Contacts: Hassan Mansour, Ulugbek S. Kamilov, Dehong Liu, Philip V. Orlik, Petros T. Boufounos. Kieran Parsons, Anthony Vetro

We propose an online blind deconvolution approach to sequential through-the-wall-radar-imaging (TWI) where the received signal is contaminated by front wall ringing artifacts. The sequential measurements correspond to individual transmitter-receiver pairs where the front wall ringing induces a multipath kernel that corrupts the received target reflections. The convolution kernels may vary across sequential measurements but are assumed to be shared among targets viewed by a single measurement. Our approach extends recent convex programming formulations for blind deconvolution to the sequential measurement scenario by formulating it as a low-rank tensor recovery problem. We develop a stochastic gradient descent algorithm that is capable of recovering the sparse scene and separating out the delay convolution kernels.

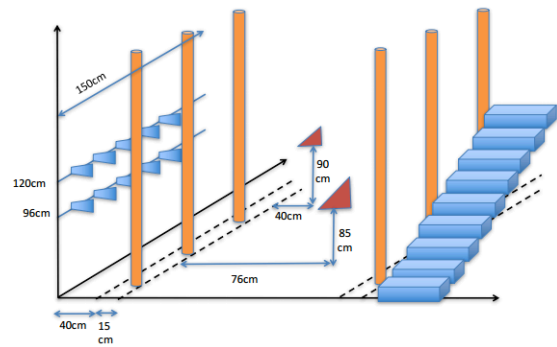

Motion-Adaptive Depth Super-Resolution

Citation: Kamilov, U.; Boufounos, P.T., “Motion-Adaptive Depth Superresolution”, *IEEE Transactions on Image Processing*, DOI: 10.1109/TIP.2017.2658944, vol. 26, no. 4, pp. 1723- 1731, January 2017.

Contacts: Ulugbek S. Kamilov, Petros T. Boufounos

Multi-modal sensing is increasingly becoming important in a number of applications, providing new capabilities and new processing challenges. In this paper we explore the benefit of combining a low-resolution depth sensor with a high-resolution optical video sensor, in order to provide a high-resolution depth map of the scene. We propose a new formulation that is able to incorporate temporal information and exploit the motion of objects in the video to significantly improve the results over existing methods. In particular, our approach exploits the space-time redundancy in the depth and intensity using motion-adaptive low-rank regularization. We provide experiments to validate our approach and confirm that the quality of the estimated high-resolution depth is improved substantially.

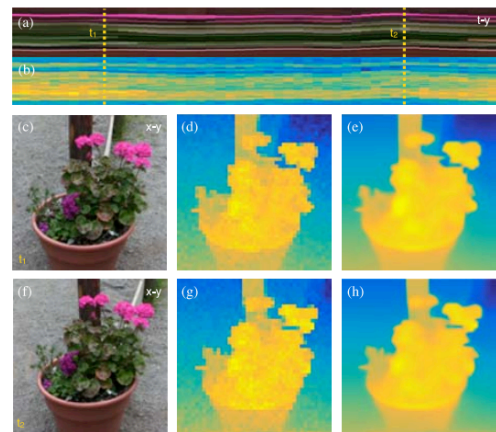

Attribute compression for sparse point clouds using graph transforms

Citation: Cohen, R.A.; Tian, D.; Vetro, A., “Attribute compression for sparse point clouds using graph transforms”, *IEEE International Conference on Image Processing (ICIP)*, DOI: 10.1109/ICIP.2016.7532583, pp. 1374-1378, September 2016.

Contacts: Robert A. Cohen, Dong Tian, Anthony Vetro

With the recent improvements in 3-D capture technologies for applications such as virtual reality, preserving cultural artifacts and mobile mapping systems, new methods for compressing 3-D point cloud representations are needed to reduce the amount of bandwidth or storage consumed. For point clouds having attributes such as color associated with each point, several existing methods perform attribute compression by partitioning the point cloud into blocks and reducing redundancies among adjacent points. If, however, many blocks are sparsely populated, few or no points may be adjacent, thus limiting the compression efficiency of the system. In this paper, we present two new methods using block-based prediction and graph transforms to compress point clouds that contain sparsely-populated blocks. One method compacts the data to guarantee one DC coefficient for each graph-transformed block, and the other method uses a K-nearest-neighbor extension to generate more efficient graphs.

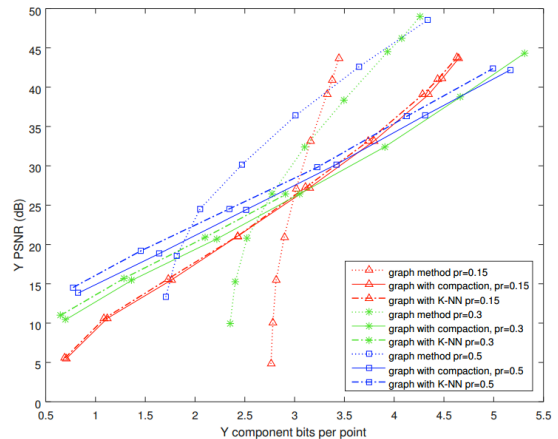

Contour-Enhanced Resampling of 3D Point Clouds Via Graphs

Citation: Chen, S.; Tian, D.; Feng, C.; Vetro, A.; Kovacevic, J., “Contour-Enhanced Resampling of 3D Point Clouds Via Graphs”, *IEEE International Conference on Acoustics, Speech, and Signal Processing (ICASSP)*, March 2017.

Contacts: Dong Tian, Chen Feng, Anthony Vetro

To reduce storage and computational cost for processing and visualizing large-scale 3D point clouds, an efficient resampling strategy is needed to select a representative subset of 3D points that can preserve contours in the original 3D point cloud. We tackle this problem by using graph-based techniques as graphs can represent underlying surfaces and lend themselves well to efficient computation. We first construct a general graph for a 3D point cloud and then propose a graph-based metric to quantify the contour information via high-pass graph filtering. Finally, we obtain an optimal resampling distribution that preserves the contour information by solving an optimization problem. The proposed graph-based resampling performs better than uniform resampling both for toy point clouds as well as real large-scale point clouds.

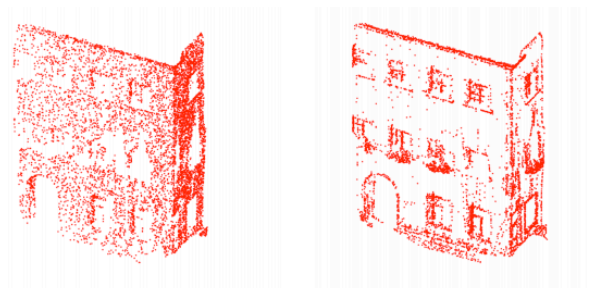

(a) Uniform resampling.

(b) Proposed resampling

Disc-Glasso: Discriminative Graph Learning with Sparsity Regularization

Citation: Kao, J.-Y.; Tian, D.; Mansour, H.; Ortega, A.; Vetro, A., “Disc-Glasso: Discriminative Graph Learning with Sparsity Regularization”, *IEEE International Conference on Acoustics, Speech, and Signal Processing (ICASSP)*, March 2017.
 Contacts: Dong Tian, Hassan Mansour, Antony Vetro

Learning graph topology from data is challenging. Previous work leads to learning graphs on which the graph signals used for training are smooth. In

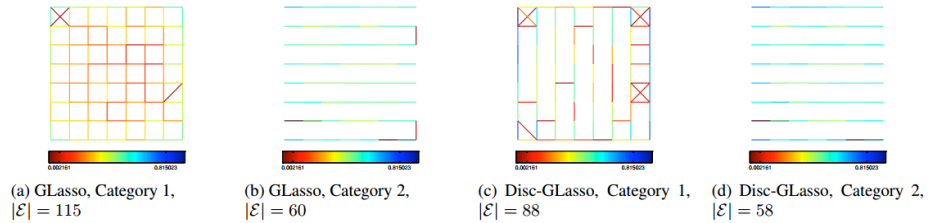

this paper, we propose an optimization framework for learning multiple graphs, each associated to a class of signals, such that representation of signals within a class and discrimination of signals in different classes are both taken into consideration. A Fisher-LDA-like term is included in the optimization objective function in addition to the conventional Gaussian ML objective. A block coordinate descent algorithm is then developed to estimate optimal graphs for different categories of signals, which are then used to efficiently classify the different signals. Experiments on synthetic data demonstrate that our proposed method can achieve better discrimination between the learned graphs.

On Methods for Privacy-Preserving Energy Disaggregation

Citation: Wang, Y.; Raval, N.J.; Ishwar, P.; Hattori, M.; Hirano, T.; Matsuda, N.; Shimizu, R., “On Methods for Privacy-Preserving Energy Disaggregation”, *IEEE International Conference on Acoustics, Speech, and Signal Processing (ICASSP)*, March 2017.
 Contacts: Ye Wang

Household energy monitoring via smart-meters motivates the problem of disaggregating the total energy usage signal into the component energy usage and operating patterns of individual appliances. While

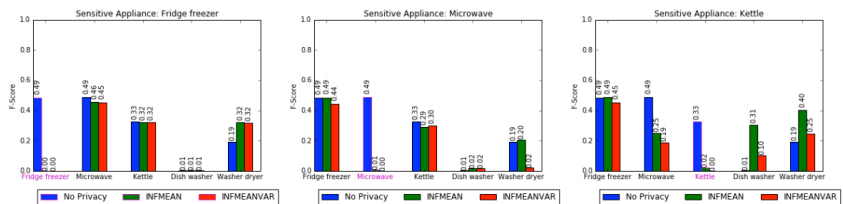

energy disaggregation enables useful analytics, it also raises privacy concerns because sensitive household information may also be revealed. Our goal is to preserve analytical utility while mitigating privacy concerns by processing the total energy usage signal. We consider processing methods that attempt to remove the contribution of a set of sensitive appliances from the total energy signal. We show that while a simple model-based approach is effective against an adversary making the same model assumptions, it is much less effective against a stronger adversary employing neural networks in an inference attack. We investigate the performance of employing neural networks to estimate and remove the energy usage of sensitive appliances.

Data Analytics

Data Analytics technologies aim to improve the performance of devices, systems, and business processes by means of collecting data, constructing predictive models from that data, and making improved decisions based on the constructed models. The Data Analytics group at MERL has been working on both predictive and decision analytics, as well as supporting fields such as signal processing, numerical methods, and information systems infrastructure. The focus of the group is on innovative high-performance algorithms that can be applied to various product lines of Mitsubishi Electric, including electrical power systems, various transportation systems (trains, elevators, cars), heating, ventilation, and air conditioning (HVAC) systems and solutions, and factory automation. The application of these algorithms minimizes costs, maximizes profits, increases reliability, improves energy efficiency, and reduces environmental impact of products.

Research on predictive analytics, supported by advances in the fields of statistical machine learning and data management aims to create accurate data-driven models of electromechanical and thermo dynamical systems, as well as models of complex natural and man-made phenomena such as road traffic and demand for electrical power. The rapidly increasing amount of available sensor data, popularly known as Industrial Big Data, necessitates the development of scalable learning algorithms with computational complexity close to linear in the number of data records.

Decision optimization research emphasizes numerical methods for fast solution of continuous and discrete optimization problems, and finds application in the analysis of electrical power systems and Smart Grids that include renewable power sources with intermittent output as well as highly variable loads such as electrical vehicles. Many problems in transportation systems such as train operation optimization, group elevator scheduling, and route guidance for car navigation, as well as energy optimization in buildings, can be reduced to planning and optimization problems. Similarly, a number of problems in factory automation and production planning and scheduling can be addressed successfully by means of decision-theoretic planning and sequential optimization algorithms based on modern reinforcement learning algorithms.

Recent Research

Learning to Control Partial Differential Equations: Regularized Fitted Q-Iteration Approach ...	62
An IoT System to Estimate Personal Thermal Comfort	62
On the Influence of State Selection on Mass Conservation in ... Vapor Compression Cycle ...	63
Dynamic State Estimation Based on ... and Distributed Generation Forecasting.....	63
Mitigating Substation Demand Fluctuations Using Decoupled Price Schemes	64
Strengthening ... Polyester 3D Printed Parts by ... Five-Axis Printing.....	64
Kernel Regression for the Approximation of Heat Transfer Coefficients	65
... Matrix Estimation with High Dimensional Data for ... Anomaly Detection Problems	65
Distributed secondary voltage controller ... to improve power quality	66
Accelerating Convergence to Competitive Equilibrium in Electricity Markets.....	66
Dynamic Charge Management for Vapor Compression Cycles.....	67
Degeneracy in Maximal Clique Decomposition for Semidefinite Programs	67
A Humidity Integrated Building Thermal Model	68
Treemaps and the Visual Comparison of Hierarchical Multidimensional Data	68

Learning to Control Partial Differential Equations: Regularized Fitted Q-Iteration Approach

Citation: Farahmand, A.-M.; Nabi, S.; Grover, P.; Nikovski, D.N., “Learning to Control Partial Differential Equations: Regularized Fitted Q-Iteration Approach”, *IEEE Conference on Decision and Control (CDC)*, DOI: 10.1109/CDC.2016.7798966, pp. 4578 – 4585, December 2016.

Contacts: Amir-massoud Farahmand, Saleh Nabi, Piyush Grover, Daniel N. Nikovski

This paper formulates a class of partial differential equation (PDE) control problems as a reinforcement learning (RL) problem. We design an RL-based algorithm that directly works with the state of PDE, an infinite dimensional vector, thus allowing us to avoid the model order reduction, commonly used in the conventional PDE controller design approaches. We apply the method to the problem of flow control for time-varying 2D convection-diffusion PDE, as a simplified model for heating, ventilating, air conditioning (HVAC) control design in a room.

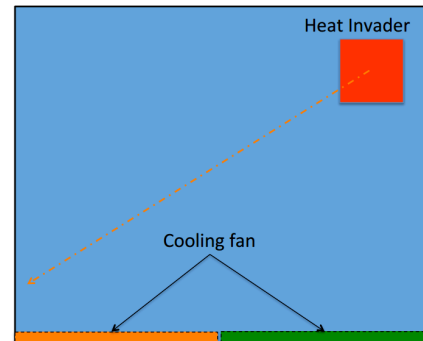

An IoT System to Estimate Personal Thermal Comfort

Citation: Laftchiev, E.; Nikovski, D.N., “An IoT System to Estimate Personal Thermal Comfort”, *IEEE World Forum on Internet of Things (WF- IoT)*, DOI: 10.1109/WF-IoT.2016.7845401, pp. 672 – 677, December 2016.

Contacts: Emil Laftchiev, Daniel N. Nikovski

Thermal comfort in office buildings is emerging as an important variable that can be used to maximize employee productivity. In this paper we propose a new Internet of Things (IoT) based system that creates a personalized model of thermal comfort. To create this model, our system collects telemetry via an IoT network of sensors and user inputs. This data is then input into machine learning algorithms that continuously calibrate and update a personalized thermal comfort model for the user. To facilitate the individuality of our models, the system combines personal measurements from the Microsoft Band, such as biometric readings and user feedback, with environmental measurements such as temperature, humidity, and air speed. In this work, we evaluate a broad set of classification and regression algorithms. Our experimental results show that using our IoT based system improves the mean squared error of the thermal prediction by about 50% when compared to the industry standard method developed by P.O. Fanger.

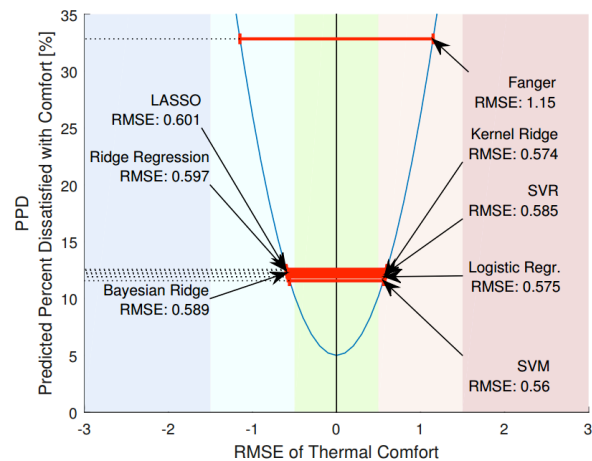

Mitigating Substation Demand Fluctuations Using Decoupled Price Schemes for Demand Response

Citation: Sun, H.; Minot, A.; Nikovski, D.N.; Hashimoto, H.; Takano, T.; Takaguchi, Y., “Mitigating Substation Demand Fluctuations Using Decoupled Price Schemes for Demand Response”, *IEEE Power & Energy Society Innovative Smart Grid Technologies Conference (ISGT)*, DOI: 10.1109/ISGT.2016.7781189, September 2016.

Contacts: Hongbo Sun, Daniel N. Nikovski

We propose a decoupled substation price model with separate charges for base energy production, up/down reserve usages and reserve usage variations. Using the decoupled price scheme, the flexible loads in the distribution system are scheduled to closely follow variations in renewable generation in order to mitigate demand fluctuations in substations. This reduces the need for reserve unit power production, thereby allowing transmission systems to operate at lower cost and higher efficiency. We formulate an optimization problem to determine the optimal scheduling of flexible loads subject to power balance, power flow and demand response constraints. The optimization problem is solvable by computationally efficient linear programming methods.

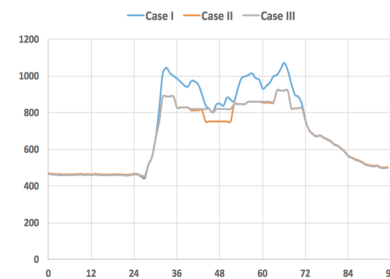

Strengthening ABS, Nylon, and Polyester 3D Printed Parts by Stress Tensor Aligned Deposition Paths and Five-Axis Printing

Citation: Yerazunis, W.S.; Barnwell III, J.C.; Nikovski, D.N., “Strengthening ABS, Nylon, and Polyester 3D Printed Parts by Stress Tensor Aligned Deposition Paths and Five-Axis Printing”, *International Solid Freeform Fabrication Symposium*, August 2016.

Contacts: William S. Yerazunis, Daniel N. Nikovski

In most fused filament fabrication systems, filament laydown paths are at constant Z height. This creates a weak direction in the resulting parts, as the interlayer adhesion between melted and solidified material is much weaker than the tensile strength of the bulk material. For example, a hemispherical dome pressure vessel endcap will fail easily along these Z=constant cleavage planes. We resolve this problem by proposing a 3D printing system that does not limit the nozzle positioning to a single Z layer at a time, or to constant pitch and yaw angle, but instead lays down extrusions more closely aligned with the stress tensor within the part. To verify this, we have constructed a working 5-axis fused-filament fabrication 3D printer and produced a number of test parts in ABS, nylon 645, and T-glase polyester. Using a commercial hydrostatic pressure system, we have tested these parts to destruction and find a typical strength improvement of 3x to 5x over conventional 3-axis parts.

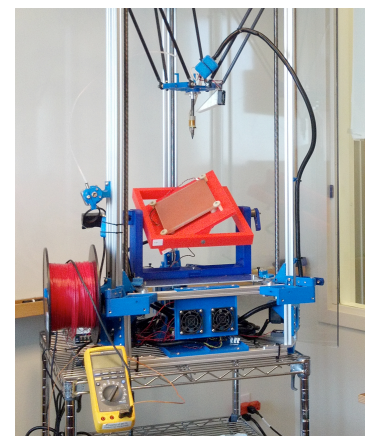

Kernel Regression for the Approximation of Heat Transfer Coefficients

Citation: Laughman, C.R.; Qiao, H.; Nikovski, D.N., “Kernel Regression for the Approximation of Heat Transfer Coefficients”, *Gustav Lorentzen Natural Working Fluids Conference*, August 2016.

Contacts: Christopher R. Laughman, Hongtao Qiao, Daniel N. Nikovski

Experimentally-based correlations and other parametric methods for approximating heat transfer coefficients, while popular, have a number of shortcomings that are manifest when they are used in dynamic simulations of thermofluid systems. This paper studies the application of a nonparametric statistical learning technique, known as kernel regression, to the problem of approximating heat transfer coefficients for single-phase and boiling flows for the use in dynamic simulation. This method is demonstrated to accurately predict heat transfer coefficients for subcooled, two-phase, and superheated flows for a finite volume model of a refrigerant pipe, as compared to results obtained from established correlations drawn from the literature.

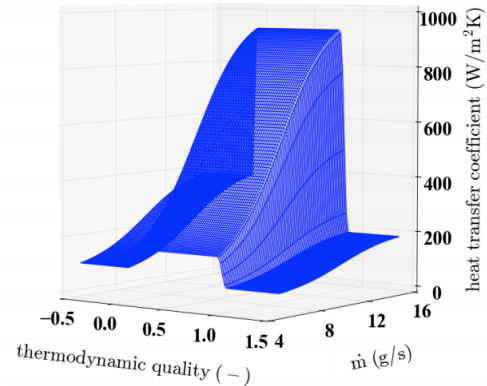

Regularized Covariance Matrix Estimation with High Dimensional Data for Supervised Anomaly Detection Problems

Citation: Nikovski, D.N.; Byadarhaly, K., “Regularized Covariance Matrix Estimation with High Dimensional Data for Supervised Anomaly Detection Problems”, *IEEE International Joint Conference on Neural Networks*, DOI: 10.1109/IJCNN.2016.7727554, pp. 2811-2818, July 2016.

Contacts: Daniel N. Nikovski

We address the problem of estimating high-dimensional covariance matrices (CM) for the explicit purpose of supervised anomaly detection, in the case when the number n of data points is lower than their dimensionality p . This is increasingly common with the emergence of the Internet of Things that makes it possible to collect data from many sensors simultaneously, resulting in very high-dimensional data sets. When we attempt to perform anomaly detection for such data by modeling the normal behavior of the system by means of a multivariate Gaussian distribution, and $n < p$, the sample CM is singular, and cannot be used directly without some form of regularization. In contrast to existing methods for CM regularization that aim to fit the training data accurately, we propose a regularization algorithm for CM estimation that directly aims to maximize the area under the resulting receiver-operator characteristic (AUROC) for the decision problem that needs to be solved: anomaly detection.

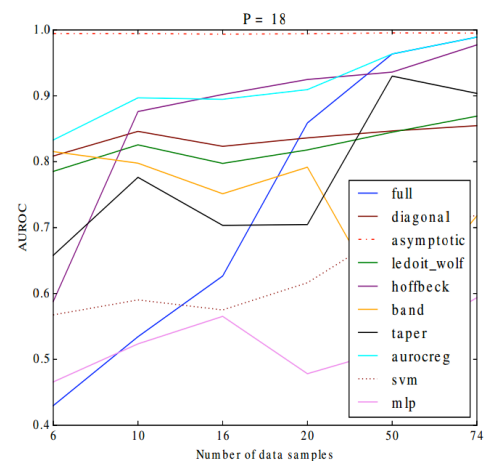

Distributed secondary voltage controller for droop-controlled micro-grids to improve power quality in power distribution networks

Citation: Wang, Z.; Sun, H.; Nikovski, D.N., “Distributed secondary voltage controller for droop-controlled microgrids to improve power quality in power distribution networks”, *IEEE Power & Energy Society General Meeting (PESGM)*, DOI: 10.1109/PESGM.2016.7741071, July 2016.

Contacts: Hongbo Sun, Daniel N. Nikovski

A distributed secondary voltage controller is designed for droop-controlled microgrids in power distribution networks to improve power quality.

Microgrids are typically managed by the droop control mechanism that ensures stability but does not guarantee power quality of voltage magnitude. To solve this power quality problem, the proposed distributed secondary voltage controller maintains a constant voltage at a microgrid's point of common coupling (PCC) using only local measurements. With the voltage regulation capability, a microgrid can be used to improve power quality so that greatly promote the microgrid's value to power system daily operations. The improved voltage regulation in a power network is demonstrated through simulation tests of a modified IEEE 37- node test feeder. Furthermore, this secondary voltage controller is compatible with existing voltage control devices, such as tapchanging transformers that automatically regulate voltage.

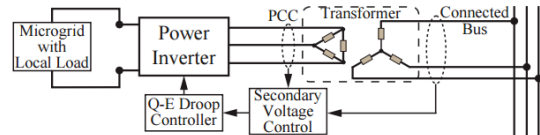

Accelerating Convergence to Competitive Equilibrium in Electricity Markets

Citation: Raghunathan, A.U.; Curtis, F.E.; Takaguchi, Y.; Hashimoto, H., “Accelerating Convergence to Competitive Equilibrium in Electricity Markets”, *IEEE Power & Energy Society General Meeting (PESGM)*, DOI: 10.1109/PESGM.2016.7741162, vol. 17, no. 3, pp. 713-727, July 2016.

Contacts: Arvind U. Raghunathan

We present a single time-period decentralized market clearing model based on the DC power flow model. The electricity market we study consists of a set of Generation Companies (GenCos) and a set of Distribution System Operators (DSOs). We model the DSOs as a single node having deferrable loads. The Independent System Operator (ISO) determines the market clearing generation and demand levels by coordinating with the market participants (GenCos and DSOs). It is assumed that each market participant shares limited information with the ISO. We exploit the problem structure to obtain a decomposition of the market-clearing problem where the GenCos and DSOs are decoupled. We propose a novel semismooth Newton algorithm to compute the competitive equilibrium. Numerical experiments demonstrate that the algorithm can obtain several orders of magnitude speedup over a typical subgradient algorithm.

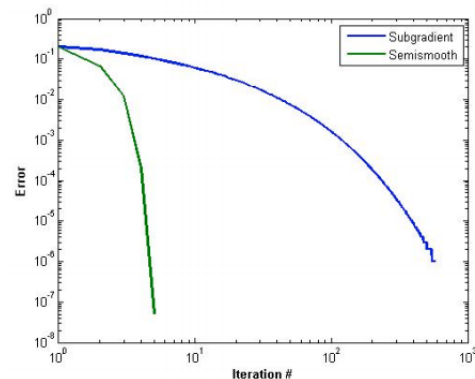

Dynamic Charge Management for Vapor Compression Cycles

Citation: Laughman, C.R.; Qiao, H.; Burns, D.J.; Bortoff, S.A., “Dynamic Charge Management for Vapor Compression Cycles”, *Purdue Air-Conditioning and Refrigeration Conference*, July 2016.

Contacts: Christopher R. Laughman, Hongtao Qiao, Daniel J. Burns, Scott A. Bortoff

While the mass of refrigerant contained in a vapor compression cycle has a significant effect on the cycle's power consumption, conventional cycle architectures cannot optimize energy efficiency by varying the mass as ambient conditions and operational requirements change. This paper proposes a new system architecture that allows the refrigerant mass circulating in the system to be

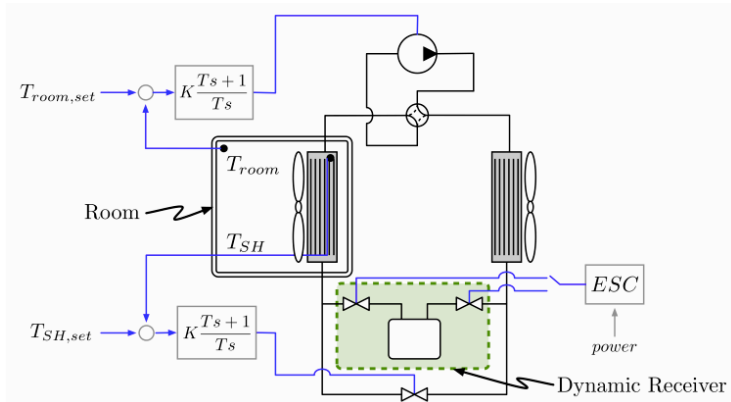

modulated over time in response to the operating conditions. This new architecture is developed with a set of dynamic cycle simulations that facilitate the specification of the mass in the cycle, and which eliminate numerical errors that can cause nonphysical fluctuations in the total mass. Controls that optimize the mass in the cycle as a function of the operating conditions are also incorporated into the overall system, allowing it to be constructed without the addition of new sensors. Gains in the coefficient of performance for this new system exceeding 10% over cycles with a fixed refrigerant charge are demonstrated.

Degeneracy in Maximal Clique Decomposition for Semidefinite Programs

Citation: Raghunathan, A.U.; Knyazev, A., “Degeneracy in Maximal Clique Decomposition for Semidefinite Programs”, *American Control Conference (ACC)*, DOI: 10.1109/ACC.2016.7526549, pp. 5605-5611, July 2016.

Contacts: Arvind U. Raghunathan, Andrew Knyazev

Exploiting sparsity in Semidefinite Programs (SDP) is critical to solving large-scale problems. The chordal completion based maximal clique decomposition is the preferred approach for exploiting sparsity in SDPs. In this paper, we show that the maximal clique-based SDP decomposition is primal degenerate when the SDP has a low rank solution. We also derive conditions under which the multipliers in the maximal cliquebased SDP formulation is not unique. Numerical experiments demonstrate that the SDP decomposition results in the schurcomplement matrix of the Interior Point Method (IPM) having higher condition number than for the original SDP formulation.

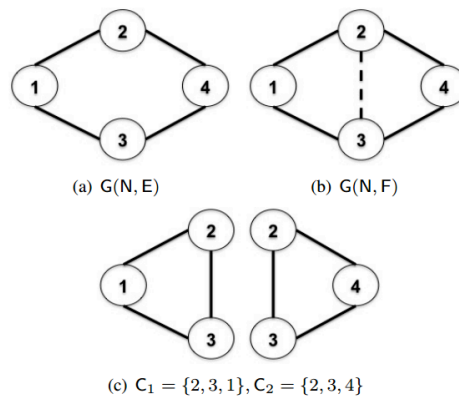

A Humidity Integrated Building Thermal Model

Citation: Xu, J.; Nikovski, D.N., “A Humidity Integrated Building Thermal Model”, *American Control Conference (ACC)*, DOI: 10.1109/ACC.2016.7525127, pp. 1492-1499, July 2016.

Contacts: Daniel N. Nikovski

A building thermal simulation model is proposed in this paper to predict temperature and humidity for short term response under varying environment inputs. This model is composite of a thermal circuit model to predict zone temperature and an enhanced BRE admittance model to predict zone humidity. Various environment factors such as weather, human activity, radiation, moisture absorption/desorption, ventilation, and condensation are considered. The training and prediction procedures are accelerated with approximations. In both laboratory and field tests, the model shows good performance on temperature and humidity estimation. To the best of our knowledge, it is the first time that a grey-box building thermal model can provide accurate humidity prediction with time step as short as 5 minutes.

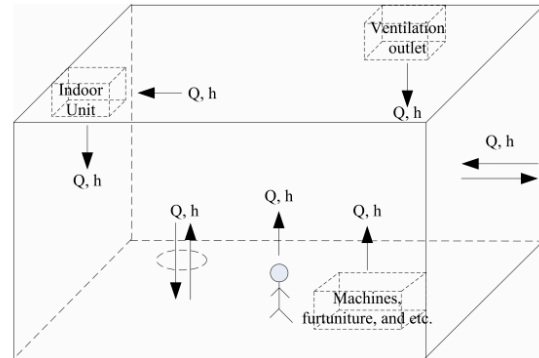

Treemaps and the Visual Comparison of Hierarchical Multidimensional Data

Citation: Wittenburg, K.B.; Turchi, T., “Treemaps and the Visual Comparison of Hierarchical Multidimensional Data”, *International Working Conference on Advanced Visual Interfaces (AVI)*, DOI: 10.1145/2909132.2909286, June 2016.

Contacts: Kent B. Wittenburg

Treemaps have the desirable property of presenting overviews along with details of data and thus are of interest in visualizations of multi-attribute tabular data with attribute

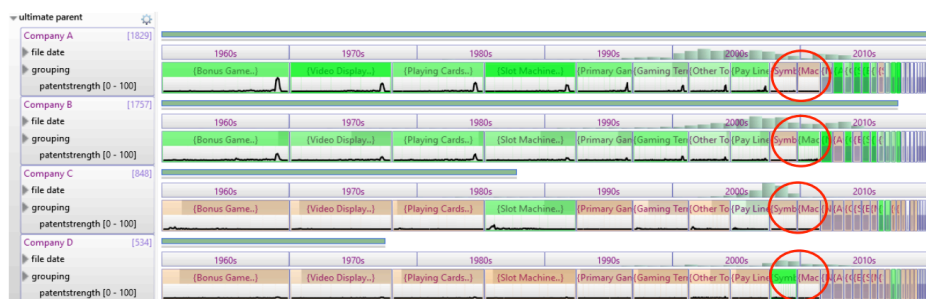

hierarchies. However, the original treemap algorithms and most subsequent variations are hampered in making parallel structures in a hierarchical data structure visually comparable. Structurally parallel elements are not aligned, making it difficult to compare them visually. We propose a method that allows for proportional and non-proportional subdivisions of subtrees while preserving visual alignment of parallel structures. We extend the framework so that other types of data visualizations can be placed within the graphical areas of a treemap to allow for the visual comparison of a broad collection of data types including temporal data.

Computer Vision

The research in the Computer Vision group at MERL covers all aspects of extracting information from images. For instance, from a picture of a scene we can compute features that allow the detection and location of specific objects. Or we learn a dictionary for the appearance of local patches in an image and use it to classify regions and objects or to improve the image quality. We can track a moving object in video to quantify its trajectory. In some cases we can modify the actual image creation process to make subsequent information extraction more effective. For instance, multiple flash exposures can be used to identify an object's edges.

Several of our current projects involve 3D analysis based on 2D images. For example, we have developed algorithms for estimation of object pose so that a robot arm can grasp an object from a cluttered workspace. In another project, we infer automobile position in a city through matching of camera images to a 3D city model. For medical radiation treatment, we align patient position by matching current x-rays to simulated x-rays obtained by project. In all these cases, the algorithms we have developed must be very fast and accurate. We have also developed algorithms that operate directly on 3D data for reconstruction, detection, and recognition.

For many years, MERL has applied machine-learning methods to imaging problems of detection, classification, segmentation and understanding. A decade ago, the Viola-Jones algorithm for face detection was a good example. More recently we have been applying deep learning for semantic scene labeling and people detection/re-identification. We have freely blended our research in 3D and machine learning to enable learning of the most effective features to use in 3D detection and estimation tasks.

Recent Research

Coupled Generative Adversarial Nets	70
User-Guided Dimensional Analysis of Indoor Building Env from ... RGB-D Sensors	70
Unsupervised Network Pretraining via Encoding Human Design	71
Point-Plane SLAM for Hand-Held 3D Sensors	71
Semantic Classification of Boundaries from an RGBD Image	72
Layered Interpretation of Street View Images.....	72
User-Guided Dimensional Analysis of Indoor Scenes Using Depth Sensors.....	73
Deep Hierarchical Parsing for Semantic Segmentation.....	73
An Improved Deep Learning Architecture for Person Re-Identification	74
Deep Active Learning for Civil Infrastructure Defect Detection and Classification.....	74
Real-time Head Pose and Facial Landmark Estimation from Depth Images Using	75
Line-Sweep: Cross-Ratio For Wide-Baseline Matching and 3D Reconstruction	75
Analysis of Shape Assumptions in 3D Reconstruction of Retina from Multiple Fundus Images	76
Fast Plane Extraction in Organized Point Clouds Using Agglomerative ... Clustering.....	76

Coupled Generative Adversarial Nets

Citation: Liu, M.-Y.; Tuzel, C.O.; Sullivan, A., "Coupled Generative Adversarial Nets", *Advances in Neural Information Processing Systems (NIPS)*, December 5, 2016.

Contacts: Alan Sullivan

We propose the coupled generative adversarial nets (CoGAN) framework for generating pairs of corresponding images in two different domains. The framework consists of a pair of generative adversarial nets, each responsible for generating images in one domain. We show that by enforcing a simple weight-sharing constraint, the CoGAN learns to generate pairs of corresponding images without existence of any pairs of corresponding images in the two domains in the training set. In other words, the CoGAN learns a joint distribution of images in the two domains from images drawn separately from the marginal distributions of the individual domains. This is in contrast to the existing multi-modal generative models, which require corresponding images for training.

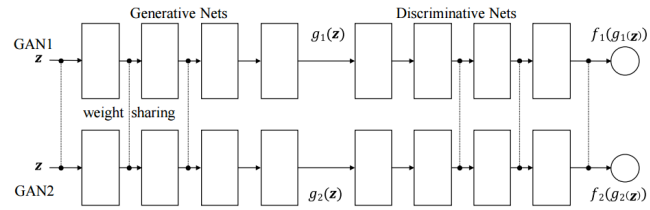

User-Guided Dimensional Analysis of Indoor Building Environments from Single Frames of RGB-D Sensors

Citation: Xiao, Y.; Feng, C.; Taguchi, Y.; Kamat, V.R., "User-Guided Dimensional Analysis of Indoor Building Environments from Single Frames of RGB-D Sensors", *Journal of Computing in Civil Engineering*, DOI: 10.1061/(ASCE)CP.1943-5487.0000648#sthash.qf8wYMXI.dpuf, November 30, 2016.

Contacts: Chen Feng, Yuichi Taguchi

In many construction, facility management, and inspection tasks, dimensional analysis of geometric features and artifacts is significant for spatial analysis and decision making. Tasks such as as-built geometry modeling and robotic workspace generation need to efficiently interpret critical dimensions of specific objects (e.g., diameter of a pipe, width of an opening) in a potentially cluttered environment based on data gathered from various positions. This paper presents a user-guided dimensional analysis approach to automatically acquire geometric information from a single frame of an RGB-D sensor. An RGB-D sensor is used to capture three-dimensional (3D) point clouds of building environments. Then, by extracting planes and performing geometric analysis, the dimensional information of objects of interest is obtained from a single frame. The user guidance system evaluates the completeness of the acquired data, and provides interactive guidance for moving the sensor to acquire complete data, from which accurate geometric measurements can be obtained.

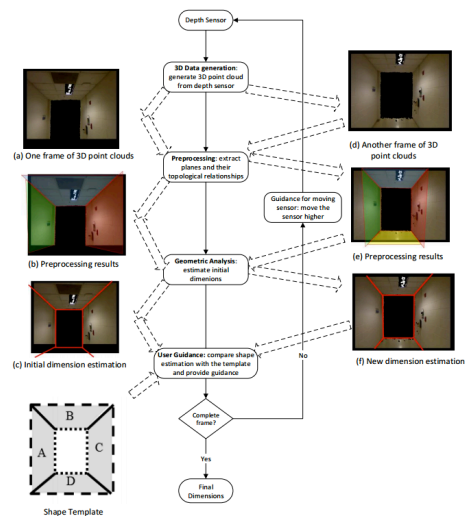

Unsupervised Network Pretraining via Encoding Human Design

Citation: Liu, M.-Y.; Mallya, A.; Tuzel, C.O.; Chen, X., “Unsupervised Network Pretraining via Encoding Human Design”, *IEEE Winter Conference on Applications of Computer Vision (WACV)*, DOI: 10.1109/WACV.2016.7477698, pp. 1-9, March 2016

Contact: Ming-Yu Liu

Over the years, computer vision researchers have spent an immense amount of effort on designing image features for the visual object recognition task. We propose to incorporate this valuable experience to guide the task of training deep neural networks. Our idea is to pretrain the network through the

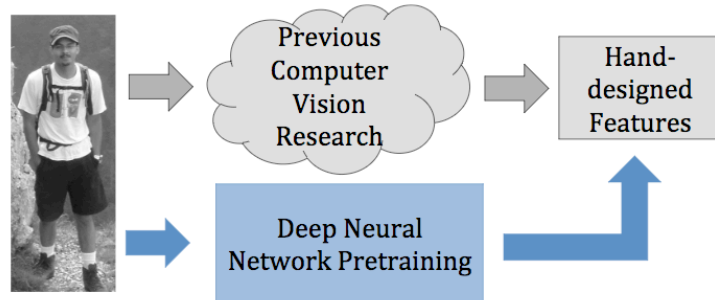

task of replicating the process of hand-designed feature extraction. By learning to replicate the process, the neural network integrates previous research knowledge and learns to model visual objects in a way similar to the hand-designed features. In a succeeding finetuning step, it further learns object-specific representations from labeled data and this boosts its classification power.

Point-Plane SLAM for Hand-Held 3D Sensors

Citation: Taguchi, Y.; Jian, Y-D; Ramalingam, S.; Feng, C., “Point-Plane SLAM for Hand-Held 3D Sensors”, *IEEE International Conference on Robotics and Automation (ICRA)*, DOI: 10.1109/ICRA.2013.6631318, ISSN: 1050-4729, ISBN: 978-1-4673-5641-1, pp. 5182-5189, May 2013

Contacts: Yuichi Taguchi, Chen Feng, Srikumar Ramalingam

We present a simultaneous localization and mapping (SLAM) algorithm for a hand-held 3D sensor that uses both points and planes as primitives. We show that it is possible to register 3D data in two different coordinate systems using any combination of three point/plane primitives (3 planes, 2 planes and 1 point, 1 plane and 2 points, and 3 points). In contrast to existing approaches that mainly use points for registration, our algorithm has the following advantages: (1) it enables faster correspondence search and registration due to the smaller number of plane primitives; (2) it produces plane-based 3D models that are more compact than point-based ones; and (3) being a global registration algorithm, our approach does not suffer from local minima or any initialization problems. Our experiments demonstrate real-time, interactive 3D reconstruction of indoor spaces using a hand-held Kinect sensor.

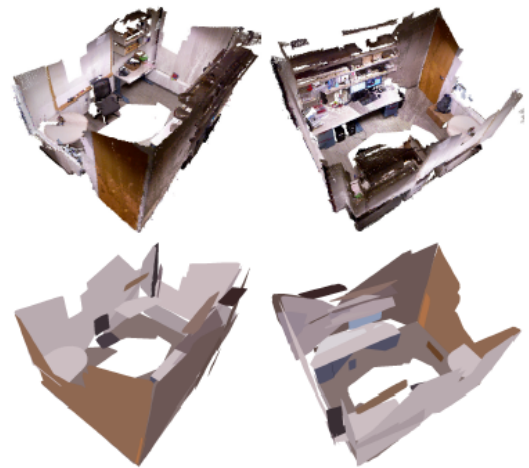

Semantic Classification of Boundaries from an RGBD Image

Citation: Soni, N.; Namboodiri, A.; Ramalingam, S.; Jawahar, C.V., “Semantic Classification of Boundaries from an RGBD Image”, *British Machine Vision Conference (BMVC)*, DOI: 10.5244/C.29.114, ISBN: 1-901725.53-7, pp. 114.1-114.12, September 2015

Contact: Srikumar Ramalingam

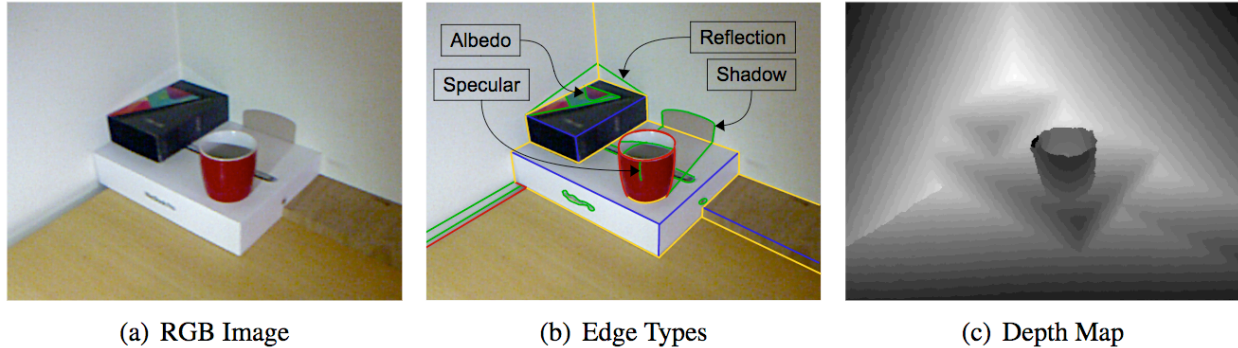

The problem of labeling the edges present in a single color image as convex, concave, and occluding entities is one of the fundamental problems in computer vision. Recently, it has been shown that this classification is not straightforward even using RGBD data. In this paper, we propose a novel algorithm using random forest for classifying edges into convex, concave and occluding entities. We release a data set with more than 500 RGBD images with pixel-wise ground labels. Our method produces promising results and achieves an F-score of 0.84.

Layered Interpretation of Street View Images

Citation: Liu, M.-Y.; Lin, A.; Ramalingam, S.; Tuzel, C.O., “Layered Interpretation of Street View Images”, *Robotics: Science and Systems Conference (RSS)*, DOI: 10.15607/RSS.2015.XI.025, July 2015

Contacts: Ming-Yu Liu, Srikumar Ramalingam

We propose a layered street view model to encode both depth and semantic information on street view images for autonomous driving. Recently, stixels, stix-mantics, and tiered scene labeling methods have been proposed to model street view images. We propose a 4-layer street view model, a compact

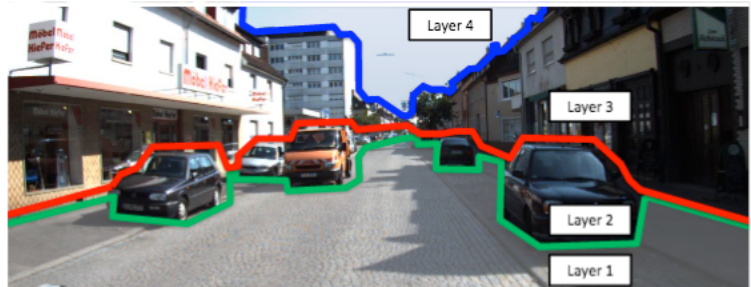

representation over the recently proposed stix-mantics model. Our layers encode semantic classes like ground, pedestrians, vehicles, buildings, and sky in addition to the depths. The only input to our algorithm is a pair of stereo images. We use a deep neural network to extract the appearance features for semantic classes. We use a simple and an efficient inference algorithm to jointly estimate both semantic classes and layered depth values. Our method outperforms other competing approaches in Daimler urban scene segmentation dataset. Our algorithm is massively parallelizable, allowing a GPU implementation with a processing speed about 9 fps.

User-Guided Dimensional Analysis of Indoor Scenes Using Depth Sensors

Citation: Xiao, Y.; Feng, C.; Taguchi, Y.; Kamat, V.R., “User-Guided Dimensional Analysis of Indoor Scenes Using Depth Sensors”, *International Symposium on Automation and Robotics in Construction and Mining (ISARC)*, June 2015

Contacts: Yuichi Taguchi, Chen Feng

In many civil engineering tasks, dimensional analysis of environmental objects is significant for spatial analysis and decision-making. Tasks such as as-built geometry generation need to efficiently interpret the critical dimensions of specific objects (e.g., diameter of a pipe, width of an opening) in a potentially cluttered environment based on data gathered from different positions. This paper presents a user-guided dimensional analysis approach to automatically acquire geometric information from a single frame of a depth sensor. Firstly a depth sensor is used to capture three-dimensional (3D) point clouds of indoor scenes. Then by extracting planes and performing geometric analysis, the dimensional information of objects of interest is obtained from a single frame. Our user guidance system evaluates the quality of the current data and measurement provides interactive guidance for moving the sensor to acquire higher quality data, from which more accurate geometric measurements can be obtained.

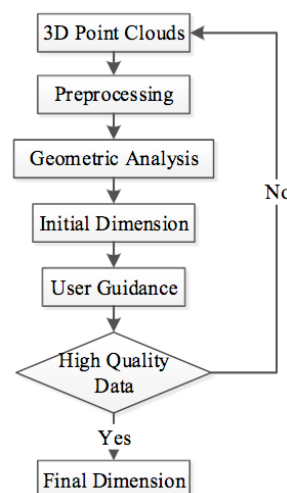

Deep Hierarchical Parsing for Semantic Segmentation

Citation: Sharma, A.; Tuzel, C.O.; Jacobs, D., “Deep Hierarchical Parsing for Semantic Segmentation”, *IEEE Conference on Computer Vision and Pattern Recognition (CVPR)*, 1503.02725v2, June 2015

This paper proposes a learning-based approach to scene parsing inspired by the deep Recursive Context Propagation Network (RCPN). RCPN is a deep feed-forward neural network that utilizes the contextual information from the entire image, through bottom-up followed by top-down context propagation via random binary parse trees. This improves the feature representation of every super-pixel in the image for better classification into semantic categories. We analyze RCPN and propose two novel contributions to further improve the model. We first analyze the learning of RCPN parameters and discover the presence of bypass error paths in the computation graph of RCPN that can hinder contextual propagation. We propose to tackle this problem by including the classification loss of the

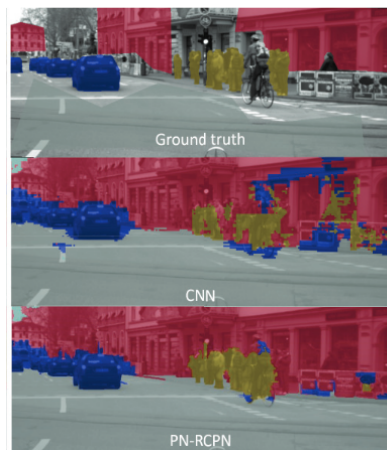

internal nodes of the random parse trees in the original RCPN loss function. Secondly, we use an MRF on the parse tree nodes to model the hierarchical dependency present in the output. Both modifications provide performance boosts over the original RCPN and the new system achieves state-of-the-art performance on Stanford Background, SIFT-Flow and Daimler urban datasets.

An Improved Deep Learning Architecture for Person Re-Identification

Citation: Ahmed, E.; Jones, M.J.; Marks, T.K., "An Improved Deep Learning Architecture for Person Re-Identification", *IEEE Conference on Computer Vision and Pattern Recognition (CVPR)*, DOI: 10.1109/CVPR.2015.7299016, pp. 3908-3916, June 2015

Contacts: Michael J. Jones, Tim K. Marks

We propose a method for simultaneously learning features and a corresponding similarity metric for person re-identification. Given a pair of images as input, our network outputs a similarity value indicating whether the two input images depict the same person. Novel elements of our architecture include a layer that computes cross-input neighborhood differences, which capture local relationships between the two input images based on midlevel features from each input image. A high-level summary of the outputs of this layer is computed by a layer of patch summary features, which are then spatially integrated in subsequent layers. Our method significantly outperforms the state of the art on both a large data set (CUHK03) and a medium-sized data set (CUHK01).

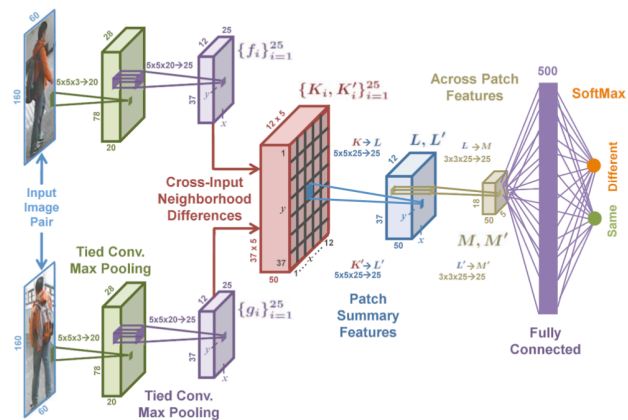

Deep Active Learning for Civil Infrastructure Defect Detection and Classification

Citation: Feng, C.; Liu, M.-Y.; Kao, C.-C.; Lee, T.-Y., "Deep Active Learning for Civil Infrastructure Defect Detection and Classification", *International Workshop on Computing in Civil Engineering (IWCCE)*, March 3, 2017.

Contacts: Chen Feng, Teng-Yok Lee

Automatic detection and classification of defects in infrastructure surface images can largely boost its maintenance efficiency. Given enough labeled images, various supervised learning methods have been investigated for this task, including decision trees and support vector machines in previous studies, and deep neural networks more recently. However, in real world applications, labels are harder to obtain than images, due to the limited labeling resources (i.e., experts). Thus we propose a deep active learning system to maximize the performance. A deep residual network is firstly designed for defect detection and classification in an image. Following our active learning strategy, this network is trained as soon as an initial batch of labeled images becomes available. It is then used to select a most informative subset of new images and query labels from experts to retrain the network. Experiments demonstrate more efficient performance improvements of our method than baselines, achieving 87.5% detection accuracy.

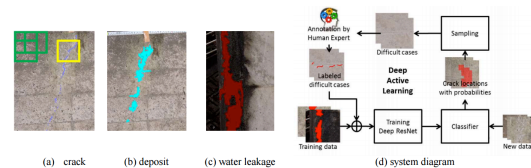

Real-time Head Pose and Facial Landmark Estimation from Depth Images Using Triangular Surface Patch Features

Citation: Papazov, C.; Marks, T.K.; Jones, M.J., "Real-time Head Pose and Facial Landmark Estimation from Depth Images Using Triangular Surface Patch Features", *IEEE Conference on Computer Vision and Pattern Recognition (CVPR)*, DOI: 10.1109/CVPR.2015.7299104, June 2015, pp. 4722-4730.

Contacts: Michael J. Jones, Tim K. Marks

We present a real-time system for 3D head pose estimation and facial landmark localization using a commodity depth sensor. We introduce a novel triangular surface patch (TSP) descriptor, which encodes the shape of the 3D surface of the face within a triangular area. The proposed descriptor is viewpoint invariant, and it is robust to noise and to variations in the data resolution. Using a fast nearest neighbor lookup, TSP descriptors from an input depth map are matched to the most similar ones that were computed from synthetic head models in a training phase. The matched triangular surface patches in the training set are used to compute estimates of the 3D head pose and facial landmark positions in the input depth map. By sampling many TSP descriptors, many votes for pose and landmark positions are generated which together yield robust final estimates. We evaluate our approach on the publicly available Biwi Kinect Head Pose Database to compare it against state-of-the-art methods. Our results show a significant improvement in the accuracy of both pose and landmark location estimates while maintaining real-time speed.

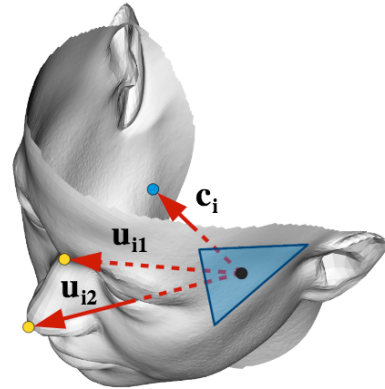

Line-Sweep: Cross-Ratio For Wide-Baseline Matching and 3D Reconstruction

Citation: Ramalingam, S.; Antunes, M.; Snow, D.; Lee, G.H.; Pillai, S., "Line-Sweep: Cross-Ratio for Wide-Baseline Matching and 3D Reconstruction", *IEEE Conference on Computer Vision and Pattern Recognition (CVPR)*, DOI: 10.1109/CVPR.2015.7298728, ISSN: 1063-6919, pp. 1238-1246, June 2015

Contacts: Srikumar Ramalingam

We propose a simple and useful idea based on cross-ratio constraint for wide-baseline matching and 3D reconstruction. Most existing methods exploit feature points and planes from images. Lines have always been considered notorious for both matching and reconstruction due to the lack of good line descriptors. We propose a method to generate and match new points using virtual lines constructed using pairs of key points, which are obtained using standard feature point detectors. We use cross-ratio constraints to obtain an initial set of new point matches, which are subsequently used to obtain line correspondences. We develop a method that works for both calibrated and un-calibrated camera configurations.



line-based model

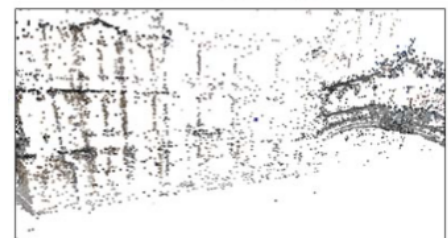

point-based model

Analysis of Shape Assumptions in 3D Reconstruction of Retina from Multiple Fundus Images

Citation: Ataer-Cansizoglu, E.; Taguchi, Y.; Kalpathy-Cramer, J.; Chiang, M.F.; Erdogmus, D., "Analysis of Shape Assumptions in 3D Reconstruction of Retina from Multiple Fundus Images", *IEEE International Symposium on Biomedical Imaging (ISBI)*, DOI: 10.1109/ISBI.2015.7164162, pp. 1502-1505, April 2015

Contacts: Yuichi Taguchi, Esra Ataer-Canisizoglu

Utilizing priors about the shape of retinal surface is important for accurate reconstruction. We present a detailed analysis of geometrical shape priors in the 3D reconstruction of retina. We first approximate the retinal surface either as a sphere inspired by the actual shape of the eyeball, or as a plane

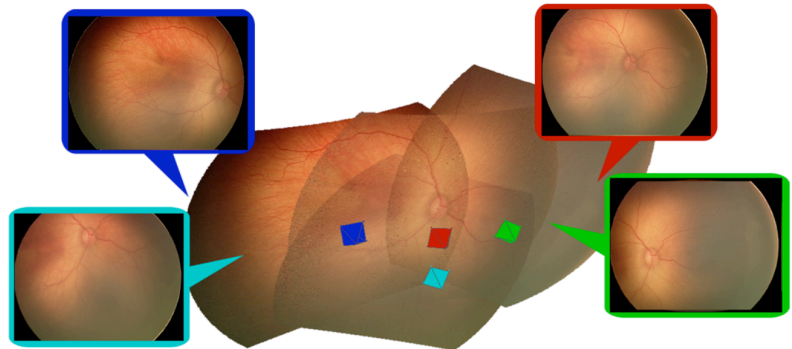

inspired by the 2D mosaicing approaches. Based on this approximation, we perform an initial camera localization with a 2D-to-3D registration procedure. Then, parameters of the surface and the camera poses are refined through a nonlinear least squares optimization using different shape priors. The resulting 3D model and camera poses can be used for intuitively visualizing the retinal images with a model-guided browsing interface.

Fast Plane Extraction in Organized Point Clouds Using Agglomerative Hierarchical Clustering

Citation: Feng, C., Taguchi, Y., Kamat, V., "Fast Plane Extraction in Organized Point Clouds Using Agglomerative Hierarchical Clustering", *IEEE International Conference on Robotics and Automation (ICRA)*, DOI: 10.1109/ICRA.2014.6907776, May 2014, pp. 6218-6225.

Contacts: Chen Feng, Yuichi Taguchi

We present a novel algorithm for reliably detecting multiple planes in real time in organized point clouds obtained from devices such as Kinect sensors. By uniformly dividing such a point cloud into non-overlapping groups of points in the image space, we first construct a graph whose node and edge represent a group of points and their neighborhood respectively. We then perform an agglomerative hierarchical clustering on this graph to systematically merge nodes belonging to the same plane until the plane fitting mean squared error exceeds a threshold. Finally we refine the extracted planes using pixel-wise region growing. Our experiments demonstrate that the proposed algorithm can reliably detect all major planes in the scene at a frame rate of more than 35Hz for 640x480 point clouds, which to the best of our knowledge is much faster than state-of-the-art algorithms.



Mechatronics

Mechatronics (mechanics + electronics) is a multidisciplinary field of engineering science that combines mechanical engineering, electrical engineering, control engineering, dynamical systems and embedded computer systems. The Mechatronics Group has expertise in multivariable, nonlinear, optimal & model predictive control theory, nonlinear estimation, nonlinear dynamical systems, mechanical design, thermo-fluid system dynamics, laser processing and sensing, and rapid prototyping. The business drivers for this R&D program are twofold. First, control of mechatronic systems is central to many areas of Mitsubishi Electric's business. Second, with the increasing power and decreasing cost of embedded computation and sensing technologies, there is the opportunity for innovation and synergy among researchers in the Mechatronics Group and other researchers in MERL's other research groups whose strengths include signal processing, computer and information technology.

Automatic control systems take real-time measurements of a system under control, process the information with a control algorithm, and apply the results of the calculation back to the system under control via actuators. Feedback is the central concept. MERL's research focuses on development of new control algorithms that provide higher performance than the state-of-the-art. Recent results include more energy efficient air conditioners and servomotors, path planning and steering control for autonomous vehicles, more precise laser processing systems, smoother riding elevators, low-fuel mission plans for space probes and satellite station keeping. MERL also conducts fundamental research to develop new control theory for general-purpose use, with a strong focus on model predictive control and nonlinear state and parameter estimation.

A dynamical system is one described by differential or difference equations. MERL's interest is to improve the performance of MELCO products and technology through the application of nonlinear dynamical systems theory. Applied research interests include mixing in fluids and thermo-fluid systems dynamics, and the design of minimum-fuel trajectories for space probes, both of which exploit nonlinearity and chaos in highly creative and deeply mathematical ways.

Recent Research

Tire-Stiffness Estimation by Marginalized Adaptive Particle Filter	78
Reduced Complexity Control Design for Symmetric LPV Systems	78
Station-keeping and Momentum-management on Halo Orbits Around L2:	79
Reference Governor for Network Control Systems Subject to Variable Time-Delay.....	79
Revisiting the State of Charge Estimation for Lithium-Ion Batteries	80
High gain observer for speed-sensorless motor drives: algorithm and experiments	80
Cooling Capacity Control for Multi-Evaporator Vapor Compression Systems	81
A Gradient-Based Approach for Optimal Plant Controller Co-Design	81
A Reconfigurable ... Model Predictive Controller for Multi-Evaporator Vapor Compression ...	82
MPC for Coupled Station Keeping, ... of Low-Thrust Geostationary Satellites	82
Stability and Feasibility of MPC for Switched Linear Systems with Dwell-time Constraints.....	83
Control of Dual-stage Processing Machines by Bounded Tracking-error MPC	83
Data-Driven Gain Computation in the Feedback Particle Filter.....	84
Reference Tracking with Guaranteed Error Bound for Constrained Linear Systems	84

Tire-Stiffness Estimation by Marginalized Adaptive Particle Filter

Citation: Berntorp, K.; Di Cairano, S., “Tire-Stiffness Estimation by Marginalized Adaptive Particle Filter”, *IEEE Annual Conference on Decision and Control (CDC)*, DOI: 10.1109/CDC.2016.7798628, pp. 2443-2448, December 2016.

Contacts: Karl Berntorp, Stefano Di Cairano

This paper considers longitudinal and lateral tire-stiffness estimation for road vehicles, using wheel-speed and inertial measurements. The deviations from nominal stiffness values are treated as disturbances acting on the vehicle, and are included in a nonlinear vehicle model. We formulate a Bayesian approach based on particle filtering, where the tire stiffness as well as the associated uncertainty are jointly

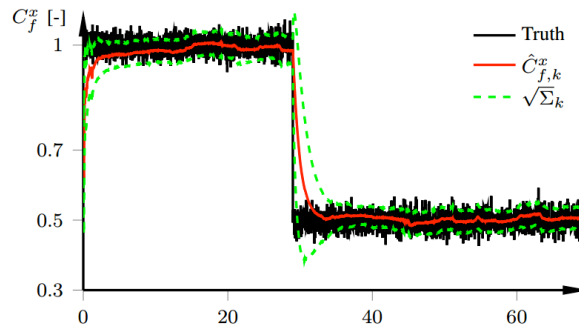

estimated together with the vehicle velocity vector, the yaw rate, and the bias components for the inertial sensors. For computational efficiency, we marginalize out the noise parameters, hence do not need to include them in the state vector. Experimental data for a double lane-change maneuver indicate that the stiffness can be estimated within a few percent of the true values.

Reduced Complexity Control Design for Symmetric LPV Systems

Citation: Danielson, C.; Di Cairano, S., “Reduced Complexity Control Design for Symmetric LPV Systems”, *IEEE Conference on Decision and Control (CDC)*, DOI: 10.1109/CDC.2015.7402088, ISBN: 978-1-4799-7884-7, pp. 72-77, December 2015.

Contacts: Claus Danielson, Stefano Di Cairano

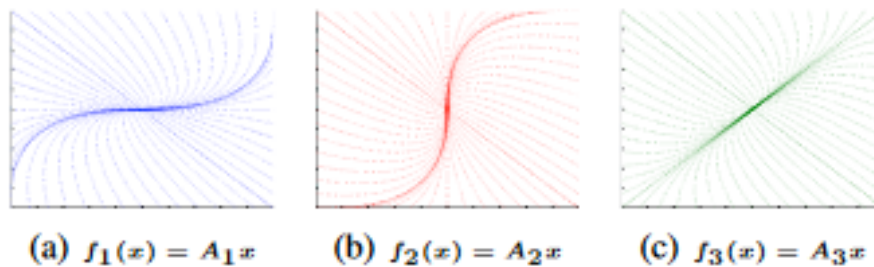

We use symmetry to reduce the computational complexity of designing parameter-dependent controllers and Lyapunov functions. We propose three complementary methods for exploiting symmetry to reduce the complexity. The first method uses symmetry to reduce the number of design variables. The second method uses symmetry to reduce the dimension of the design variables. And the third method reduces the number of linear matrix inequalities that the design variables must satisfy. We apply our reduced complexity control design to a building control problem. We show that, for this example, our method leads to an exponential decrease in the number of design variables and linear matrix inequalities.

Station-keeping and Momentum-management on Halo Orbits Around L2: Linear-quadratic Feedback and Model Predictive Control Approaches

Citation: Kalabic, U.V., Weiss, A., Di Cairano, S., Kolmanovsky, I.V., "Station-keeping and momentum-management on halo orbits around L2: Linear-quadratic feedback and model predictive control approaches", *AAS/AIAA Space Flight Mechanics Meeting*, January 2015.

Contacts: Uros V. Kalabic, Avishai Weiss, Stefano Di Cairano

The control of station-keeping and momentum-management is considered while tracking a halo orbit centered at the second Earth-Moon Lagrangian point. Multiple schemes based on linear-quadratic feedback control and model predictive control (MPC) is considered and it is shown that the method based on periodic MPC performs best for position tracking. The scheme is then extended to incorporate attitude control requirements and numerical simulations are presented demonstrating that the scheme is able to achieve simultaneous tracking of a halo orbit and dumping of momentum while enforcing tight constraints on pointing error.

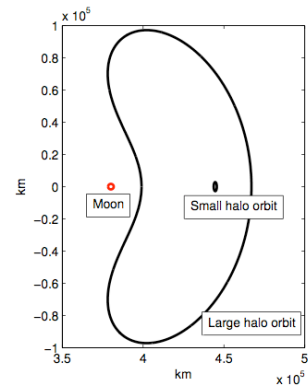

Reference Governor for Network Control Systems Subject to Variable Time-Delay

Citation: Di Cairano, S.; Kalabic, U.V.; Kolmanovsky, I.V., "Reference Governor for Network Control Systems Subject to Variable Time-Delay", *Automatica (Journal of IFAC)*, DOI: 10.1016/j.automatica.2015.09.006, Vol. 62, pp. 77-86, December 2015

Contacts: Stefano Di Cairano, Uros V. Kalabic

The handling of constraints in systems subject to variable time-delay is a challenging problem. It is particularly relevant to Network Control Systems (NCSs) in which a control system is remotely located with respect to the plant to be controlled. In this paper, we develop reference governors for controlling constrained systems subject to variable delays with a particular focus on the application to NCSs. In the proposed

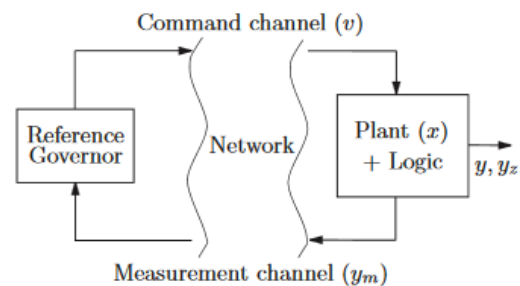

approach, which neither exploits nor depends on any explicit synchronization between the plant and the governor, the closed-loop dynamics are modeled by a sampled data system, for which input delays result in additive disturbances with magnitude proportional to the input rate of change. We first develop a network reference governor (netRG) that guarantees constraint enforcement and finite-time convergence for variable time-delay shorter than the sampling period. Then, we extend the network reference governor to the case of output feedback. Finally, we consider the case of long and potentially unbounded delay. The netRGs is evaluated in a case study of orientation control of a spacecraft with a flexible appendage.

Revisiting the State of Charge Estimation for Lithium-Ion Batteries A Methodical Investigation of the EKF Approach

Citation: Wang, Y.; Fang, H.; Zhou, L.; Wada, T., “Revisiting the State of Charge Estimation for Lithium-Ion Batteries A Methodical Investigation of the EKF Approach”, *IEEE Control Systems Magazine*, October 2016.

Contacts: Yebin Wang

This article is devoted to nonlinear state and parameter estimation problems where the system is represented in the state-space framework. This article comprises of two parts where the first part provides a tutorial on prevailing nonlinear stochastic estimation techniques, and the second part presents a self-contained description of estimation problems and solutions in rechargeable Lithium-ion batteries.

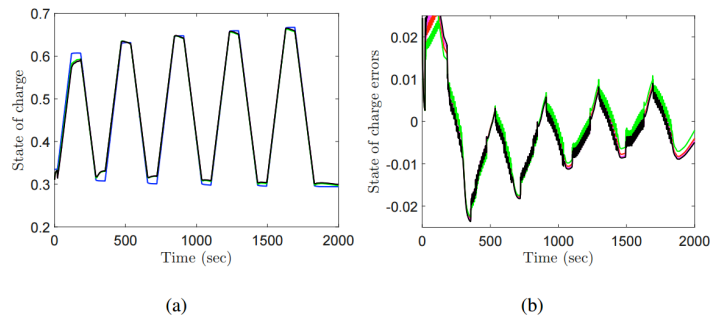

High gain observer for speed-sensorless motor drives: algorithm and experiments

Citation: Wang, Y.; Zhou, L.; Bortoff, S.A.; Satake, A.; Furutani, S., “High gain observer for speed-sensorless motor drives: algorithm and experiments”, *IEEE International Conference on Advanced Intelligent Mechatronics*, DOI: 10.1109/AIM.2016.7576921, pp. 1127 – 1132, July 2016.

Contacts: Yebin Wang, Scott A. Bortoff

This paper considers the rotor speed and flux estimation for induction motors, which is one of the key problems in speed-sensorless motor drives. Existing approaches, e.g. adaptive, Kalman filter-based, and sliding mode observer, have limitations such as unnecessarily assuming the rotor speed as a constant parameter, failure to ensure convergence of estimation error dynamics, or conservative design. This paper proposes a nontriangular observable form-based estimation algorithm. This paper presents realizable observers to avoid transforming the induction motor model into the form. Advantages of the new estimation algorithm include guaranteed stability of estimation error dynamics, constructive observer design, ease of tuning, and improved speed estimation performance. Finally, experiments are conducted to demonstrate the effectiveness of the proposed estimation algorithm.

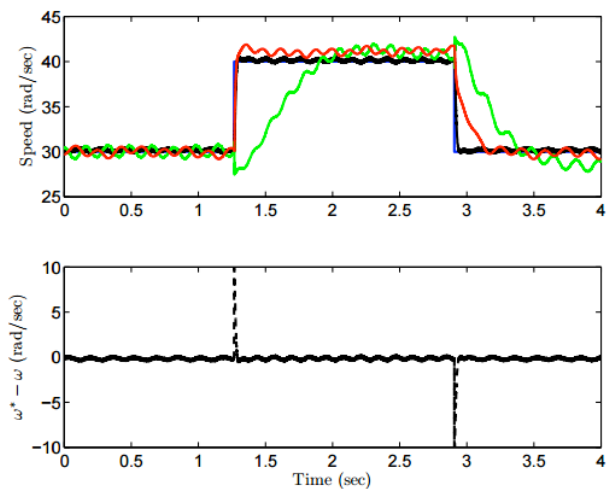

Cooling Capacity Control for Multi-Evaporator Vapor Compression Systems

Citation: Burns, D.J.; Bortoff, S.A., “Cooling Capacity Control for Multi-Evaporator Vapor Compression Systems”, *International Refrigeration and Air conditioning Conference at Purdue*, July 2016.
 Contacts: Daniel J. Burns, Scott A. Bortoff

Multi-evaporator vapor compression systems (ME-VCS) provide cooling to multiple zones. The thermodynamic conditions in these zones are independent: the heat loads often differ, and the occupants of these spaces often have different desired room temperatures. Therefore, in order to regulate each zone to its desired set-point temperature, the amount of thermal energy removed by each evaporator must be controlled independently. However, a common evaporating pressure introduces coupling between all the evaporators that makes this objective difficult--the valve and piping arrangement imposes the constraint that all evaporators operate at the same temperature. We describe the following empirical phenomenon exploited for control: as the inlet valve is decreased, refrigerant mass flow rate entering the heat exchanger is reduced, and at some critical flow rate, refrigerant is shown to preferentially flow in some paths more than others, causing maldistribution. This uneven refrigerant distribution is repeatable, reduces the capacity in a continuous manner and can be exploited with feedback controllers to regulate the per-zone cooling. A feedback controller is designed to provide stability and robustness to per-zone conditions and set points for this controller that relate per-path superheat temperature to overall evaporator capacity is created in such a way as to be robust to changes in local zone temperatures and the overall system evaporating temperature. This strategy provides zone decoupling and ultimately creates a virtual control input for a supervisory controller such as a model predictive controller.

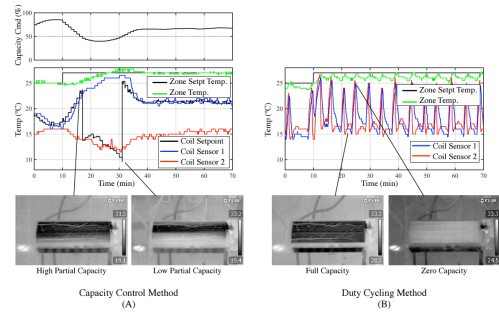

A Gradient-Based Approach for Optimal Plant Controller Co-Design

Citation: Wang, Y.-S.; Wang, Y., “A Gradient-Based Approach for Optimal Plant Controller Co-Design”, *American Control Conference (ACC)*, DOI: 10.1109/ACC.2015.7171833, ISBN: 978-1-4799-8685-9, pp. 3249-3254, July 2015
 Contacts: Yebin Wang

This paper proposes a gradient-based iterative algorithm for optimal co-design of a linear physical plant and a controller. The algorithm does not rely on the common linear parameterization assumption, and thus is applicable to a broader class of problems. The convergence of the algorithm and the verification procedure for a local minimum are given. Numerical examples show that our algorithm is comparable to other complicated algorithms in terms of the performance, but can deal with a more general class of problems.

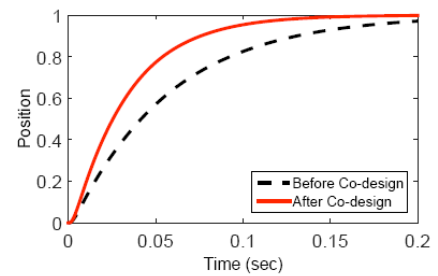

A Reconfigurable Plug-and-Play Model Predictive Controller for Multi-Evaporator Vapor Compression Systems

Citation: Zhou, J.; Burns, D.J.; Danielson, C.; Di Cairano, S., “A Reconfigurable Plug-and-Play Model Predictive Controller for Multi-Evaporator Vapor Compression Systems”, *American Control Conference (ACC)*, DOI: 10.1109/ACC.2016.7525270, pp. 2358-2364, July 2016.

Contacts: Daniel J. Burns, Claus Danielson, Stefano Di Cairano

This paper presents a reconfigurable Plug-and-Play (PnP) Model Predictive Controller (MPC) for multi-evaporator vapor compression systems (VCSs) where individual evaporators are permitted to turn on or off. To compare the performance of the proposed approach, a more conventional switched MPC is also developed in order to provide a benchmark design. Results confirm that the reconfigurable PnP MPC maintains the same performance as a switched MPC approach in terms of room temperature reference tracking after zones are switched on, enforcement of critical machine constraints, and disturbance rejection. However, reconfigurable PnP MPC requires no extra tuning or controller design effort, and can be automatically synthesized from a single master controller design for any VCS operating mode.

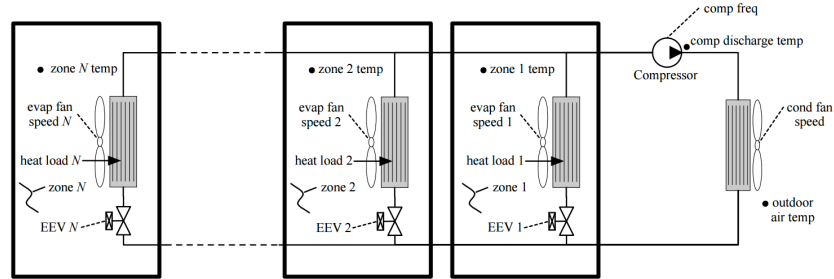

MPC for Coupled Station Keeping, Attitude Control, and Momentum Management of Low-Thrust Geostationary Satellites

Citation: Walsh, A.; Di Cairano, S.; Weiss, A., “MPC for Coupled Station Keeping, Attitude Control, and Momentum Management of Low-Thrust Geostationary Satellites”, *American Control Conference (ACC)*, DOI: 10.1109/ACC.2016.7526842, pp. 7408-7413, July 2016.

Contacts: Stefano Di Cairano, Avishai Weiss

This paper develops a model predictive control (MPC) policy for simultaneous station keeping, attitude control, and momentum management of a nadir-pointing geostationary satellite equipped with three reaction wheels and four gimbaled electric thrusters that are located on the anti-nadir face of the satellite. The MPC policy works in combination with an inner loop Sop3q-based attitude controller that ensures the satellite maintains a nadir-pointing attitude. The policy is able to maintain the satellite's position within a prescribed latitude and longitude window, while minimizing the thruster v required.

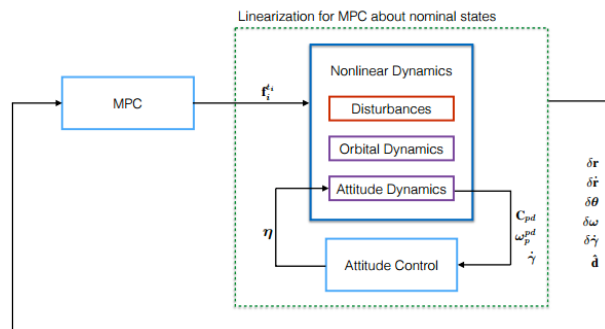

Stability and Feasibility of MPC for Switched Linear Systems with Dwell-time Constraints

Citation: Bridgeman, L.; Danielson, C.; Di Cairano, S., "Stability and Feasibility of MPC for Switched Linear Systems with Dwell-time Constraints", *American Control Conference (ACC)*, DOI: 10.1109/ACC.2016.7525323, pp. 2681-2686, July 2016.

Contacts: Claus Danielson, Stefano Di Cairano

This paper considers the control of discrete-time switched linear systems using model predictive control. A model predictive controller is designed with terminal cost and constraints depending on the terminal mode of the switched linear system. Conditions on the terminal cost and constraints are presented to ensure persistent feasibility and stability of the closed-loop system given sufficiently long dwell-time. A procedure is proposed to numerically compute admissible terminal costs and constraint sets.

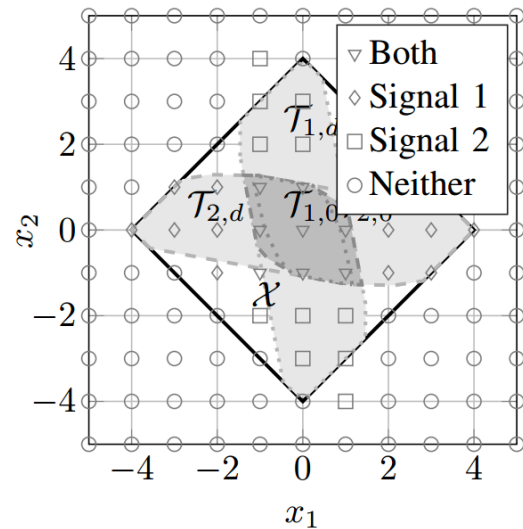

Control of Dual-stage Processing Machines by Bounded Tracking-error MPC

Citation: Di Cairano, S.; Goldsmith, A.M., "Control of Dual-stage Processing Machines by Bounded Tracking-error MPC", *American Control Conference (ACC)*, DOI: 10.1109/ACC.2016.7525167, pp. 1735-1740, July 2016.

Contacts: Stefano Di Cairano, Abraham M. Goldsmith

We consider a dual-stage precision manufacturing machine where a worktool is actuated via a motion system consisting of a "fast" stage with large bandwidth but small operating range, and a "slow" stage with smaller bandwidth but larger operating range. We design a controller based on a recently developed tracking method for constrained systems that guarantees enforcement of constraints and of an assigned bound on the tracking error. For satisfying the controller assumption, we design a reference trajectory generation algorithm that is simple and can also be executed offline. The proposed control system guarantees correct processing of the pattern and finite processing time, for which bounds can be easily computed.

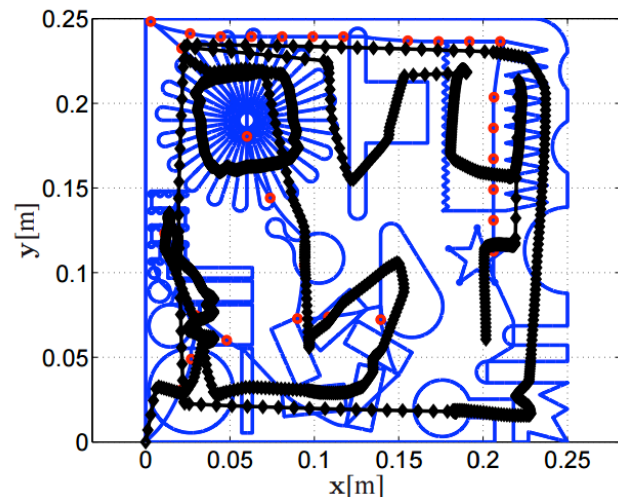

Data-Driven Gain Computation in the Feedback Particle Filter

Citation: Berntorp, K.; Grover, P., "Data-Driven Gain Computation in the Feedback Particle Filter", *American Control Conference (ACC)*, DOI: 10.1109/ACC.2016.7525328, pp. 2711-2716, July 2016.

Contacts: Karl Berntorp, Piyush Grover

The recently introduced feedback particle filter (FPF) is a control-oriented particle filter (PF) aimed at estimation of nonlinear/non-Gaussian systems. The FPF controls each particle using feedback from the measurements and is resampling free, which is in contrast to conventional PFs based on importance sampling. The control gains are computed by solving boundary value problems. In general, numerical approximations are required and it is an open

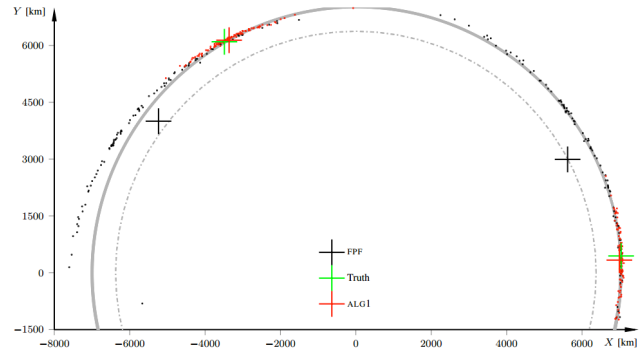

question how to properly compute the approximate solution. This paper outlines a novel method inspired by high-dimensional data-analysis techniques. Based on the time evolution of the particle cloud, we compute values of the gain function for each particle. We exemplify applicability and highlight the benefit of the approach on a planar two-body problem.

Reference Tracking with Guaranteed Error Bound for Constrained Linear Systems

Citation: Di Cairano, S.; Borrelli, F., "Reference Tracking with Guaranteed Error Bound for Constrained Linear Systems", *IEEE Transactions on Automatic Control*, DOI: 10.1109/TAC.2015.2491738, ISSN: 0018-9286, Vol. PP, pp. 1, October 2015.

Contacts: Stefano Di Cairano

We propose a control design for a constrained linear system to track reference signals within a given bounded error. The admissible reference signals are generated as output trajectories of a reference generator, which is a linear system driven by unknown bounded inputs. The controller has to track the reference signals and to never violate a given tracking error bound, while satisfying state and input constraints, for any admissible reference. The design is based on a model predictive controller (MPC) enforcing a polyhedral robust control invariant set defined by the system and reference generator models and constraints. We describe an algorithm to compute the robust control invariant set and how to design the tracking MPC law that guarantees satisfaction of the tracking error bound and of the system constraints, and achieves persistent feasibility.

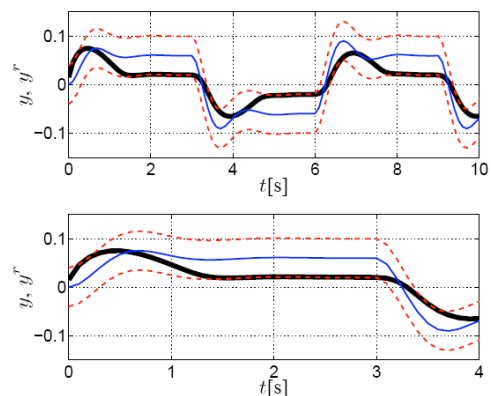

Algorithms

Researchers in the Algorithms group at MERL develop solution methods for optimization problems involving very large numbers of variables or real-time computing, particularly in settings where current methods are not viable. Our results can open new business opportunities where there are no competitive technologies. Much of the group's work involves graph-based optimizations, where the graph is a representation of the problem and associated computational constraints such as the dataflow of a parallel computer. This meshes with and helps build MERL's expertise in fields and technologies such as machine learning, computer vision, dynamic programming, convex optimization, computational mathematics, control, and signal processing. Another main research theme involves adaptively-sampled distance fields (ADFs), an efficient representation for shapes of any dimension. ADFs have distinct advantages over alternative forms, including superior font and graphical rendering for digital displays.

Recent Research

Conjugate Gradient Acceleration of Non-Linear Smoothing Filters	86
Edge-Enhancing Filters with Negative Weights.....	86
Preconditioning for Continuation Model Predictive Control.....	87
Projection-free Parallel Quadratic Programming for Linear Model Predictive Control.....	87
Parallel Quadratic Programming for Image Processing.....	88
Lifting 3D Manhattan Lines from a Single Image.....	88
Sharp images from freeform optics and extended light sources	89
Least squares dynamics in Newton-Krylov Model Predictive Control	89
Multi-exponential Lifetime Extraction in Time-logarithmic Scale	90
Sparse Preconditioning for Model Predictive Control.....	90
Accelerated Graph-based Nonlinear Denoising Filters	91

Conjugate Gradient Acceleration of Non-Linear Smoothing Filters

Citation: Knyazev, A.; Malyshev, A., “Conjugate Gradient Acceleration of Non-Linear Smoothing Filters”, *IEEE Global Conference on Signal and Information Processing (GlobalSIP)*, DOI: 10.1109/GlobalSIP.2015.7418194, pp. 245-249, December 2015

Contacts: Andrew Knyazev

The most efficient signal edge-preserving smoothing filters, e.g., for denoising, are non-linear. Thus, their acceleration is challenging and is often performed in practice by tuning filter parameters, such as by increasing the width of the local smoothing neighborhood, resulting in more aggressive smoothing of a single sweep at the cost of increased edge blurring. We propose an alternative technology, accelerating the original filters without tuning, by running them through a special conjugate gradient method, not affecting their quality. The filter nonlinearity is dealt with by careful freezing and restarting. Our initial numerical experiments on toy one-dimensional signals demonstrate 20x acceleration of the classical bilateral filter and 3-5x acceleration of the recently developed guided filter.

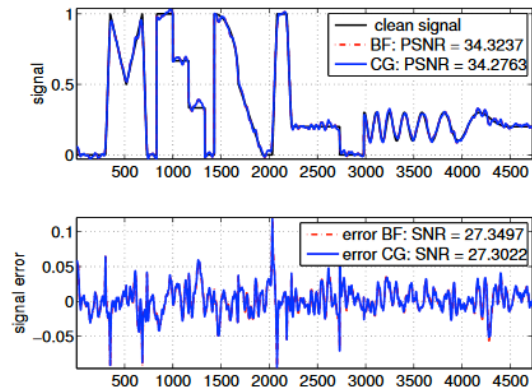

Edge-Enhancing Filters with Negative Weights

Citation: Knyazev, A., “Edge-Enhancing filters with Negative Weights”, *IEEE Global Conference on Signal and Information Processing (GlobalSIP)*, DOI: 10.1109/GlobalSIP.2015.7518197, pp. 260-264, December 2015

Contact: Andrew Knyazev

In [doi:10.1109/ICMEW.2014.6890711], a graph-based denoising is performed by projecting the noisy image to a lower dimensional Krylov subspace of the graph Laplacian, constructed using non-negative weights determined by distances between image data corresponding to image pixels. We extend the construction of the graph Laplacian to the case, where some graph weights can be negative. Removing the positivity constraint provides a more accurate inference of a graph model behind the data, and thus can improve quality of filters for graphbased signal processing, e.g., denoising, compared to the standard construction, without affecting the computational costs.

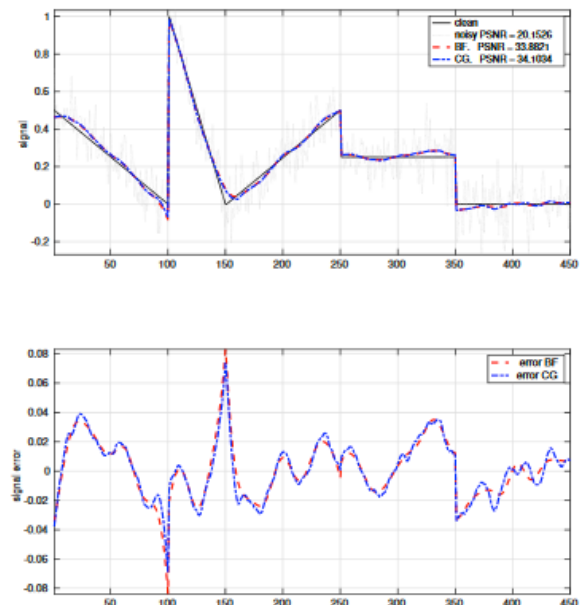

Preconditioning for Continuation Model Predictive Control

Citation: Knyazev, A.; Malyshev, A., “Preconditioning for Continuation Model Predictive Control”, IFAC Conference on Nonlinear Model Predictive Control, DOI: 10.1016/j.ifacol.2015.11.282, Vol. 48, pp.191-196, September 2015
 Contact: Andrew Knyazev

Model predictive control (MPC) anticipates future events to take appropriate control actions. Nonlinear MPC (NMPC) deals with nonlinear models and/or constraints. A Continuation/GMRES Method for NMPC, suggested by T. Ohtsuka in 2004, uses the GMRES iterative algorithm to solve a forward difference approximation $Ax = b$ of the original NMPC equations on every time step. We have previously proposed accelerating the GMRES and MINRES convergence by preconditioning the coefficient matrix A . We now suggest simplifying the construction of the preconditioner, by approximately solving a forward recursion for the state and a backward recursion for the costate, or simply reusing previously computed solutions.

$$F[U, x, t] = \begin{bmatrix} \frac{\partial H^T}{\partial u}(\tau_0, x_0, \lambda_1, u_0, \mu_0, p)\Delta\tau \\ \vdots \\ \frac{\partial H^T}{\partial u}(\tau_i, x_i, \lambda_{i+1}, u_i, \mu_i, p)\Delta\tau \\ \vdots \\ \frac{\partial H^T}{\partial u}(\tau_{N-1}, x_{N-1}, \lambda_N, u_{N-1}, \mu_{N-1}, p)\Delta\tau \\ C(\tau_0, x_0, u_0, p)\Delta\tau \\ \vdots \\ C(\tau_i, x_i, u_i, p)\Delta\tau \\ \vdots \\ C(\tau_{N-1}, x_{N-1}, u_{N-1}, p)\Delta\tau \\ \psi(x_N, p) \\ \frac{\partial \phi^T}{\partial p}(x_N, p) + \frac{\partial \psi^T}{\partial p}(x_N, p)\nu \\ + \sum_{i=0}^{N-1} \frac{\partial H^T}{\partial p}(\tau_i, x_i, \lambda_{i+1}, u_i, \mu_i, p)\Delta\tau \end{bmatrix}$$

Projection-free Parallel Quadratic Programming for Linear Model Predictive Control

Citation: Di Cairano, S.; Brand, M.E.; Bortoff, S.A., “Projection-free Parallel Quadratic Programming for Linear Model predictive Control”, *International Journal of Control*, DOI: 10.1080/00207179.2013.801080, Vol. 86, Issue 8, pp. 1367-1385, July 2013
 Contacts: Stefano Di Cairano, Matthew Brand, Scott Bortoff

A key component in enabling the application of model predictive control (MPC) in fields such as automotive, aerospace and factory automation is the availability of low-complexity fast optimization algorithms to solve the MPC finite horizon optimal control problem in architectures with reduced computational capabilities. In this paper we introduce a projection-free iterative optimization algorithm and discuss its application to linear MPC. The algorithm, originally developed by Brand for non-negative quadratic programs, is based on a multiplicative update rule and it is shown to converge to a fixed point, which is the optimum. An acceleration technique based on a projection-free line search is also introduced, to speed-up the convergence to the optimum. The algorithm is applied to MPC through the dual of the quadratic program (QP) formulated from the MPC finite time optimal control problem. We discuss how termination conditions with guaranteed degree of sub-optimality can be enforced, and how the algorithm performance can be optimized by pre-computing the matrices in a parametric form. We show computational results of the algorithm in three common case studies.

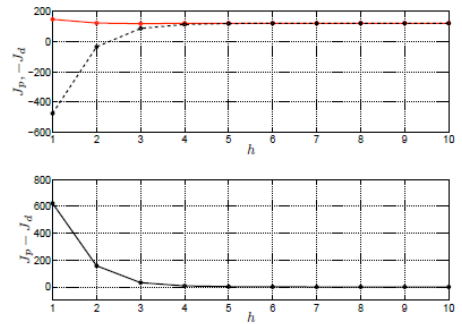

Parallel Quadratic Programming for Image Processing

Citation: Brand, M.; Chen, D., “Parallel Quadratic Programming for Image Processing”, *IEEE International Conference on Image Processing (ICIP)*, DOI: 10.1109/ICIP.2011.6116089, pp. 2261-2264, September 2011

Contacts: Matthew Brand

Many image processing and computer vision problems can be solved as quadratic programs in the non-negative cone. This paper develops a provably convergent multiplicative update that has a simple form and is amenable to fine-grained data parallelism. Classic algorithms for deblurring, matrix factorization, and tomography are recovered as special cases. This paper also demonstrates applications to super-resolution, labeling and segmentation.

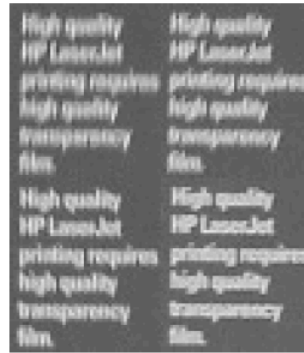

(a) 4 of 30 low-res images



(b) reconstructed high-res image

Lifting 3D Manhattan Lines from a Single Image

Citation: Ramalingam, S.; Brand, M.E., “Lifting 3D Manhattan Lines from a Single Image”, *IEEE International Conference on Computer Vision (ICCV)*, DOI: 10.1109/ICCV.2013.67, ISSN: 1550-5499, pp. 497-504, December 2013

Contacts: Matthew Brand

We propose a novel and an efficient method for reconstructing the 3D arrangement of lines extracted from a single image, using vanishing points, orthogonal structure, and an optimization procedure that considers all plausible connectivity constraints between lines. Line detection identifies a large number of salient lines that intersect or nearly intersect in an image, but relatively few of these apparent junctions correspond to real intersections in the 3D scene. We use linear programming (LP) to identify a minimal set of least-violated connectivity constraints that are sufficient to unambiguously reconstruct the 3D lines. In contrast to prior solutions that primarily focused on well-behaved synthetic line drawings with severely restricting assumptions, we develop an algorithm that can work on real images.



(a)

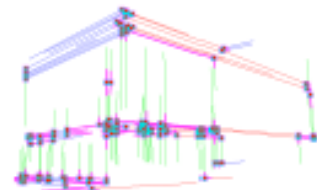

(b)



(c)



(d)

Sharp images from freeform optics and extended light sources

Citation: Brand, M.E., Aksoylar, A., "Sharp images from freeform optics and extended light sources", *OSA Frontiers in Optics*, DOI: 10.1364/FIO.2016.FW5H.2, ISBN: 978-1-943580-19-4, October 2016.

Contact: Matthew Brand



We introduce a class of pictorial irradiance patterns that freeform optics can render sharply despite the blurring effect of extended light sources; show how to solve for the freeform geometry; and demonstrate a fabricated lens.

Least squares dynamics in Newton-Krylov Model Predictive Control

Citation: Knyazev, A., Malyshev, A., "Least squares dynamics in Newton-Krylov Model Predictive Control"

Contact: Andrew Knyazev

Newton-Krylov methods for nonlinear Model Predictive Control were pioneered by T. Ohtsuka under the name "C/GMRES". Ohtsuka eliminates a system state over the horizon from Karush-Kuhn-Tucker stationarity conditions of a Lagrangian using equations of system dynamics. We propose instead using least squares to fit the state to the dynamics and some constraints on the state, if they are inconsistent. Correspondingly modified Newton-Krylov methods are described. Numerical tests demonstrate workability of our modification.

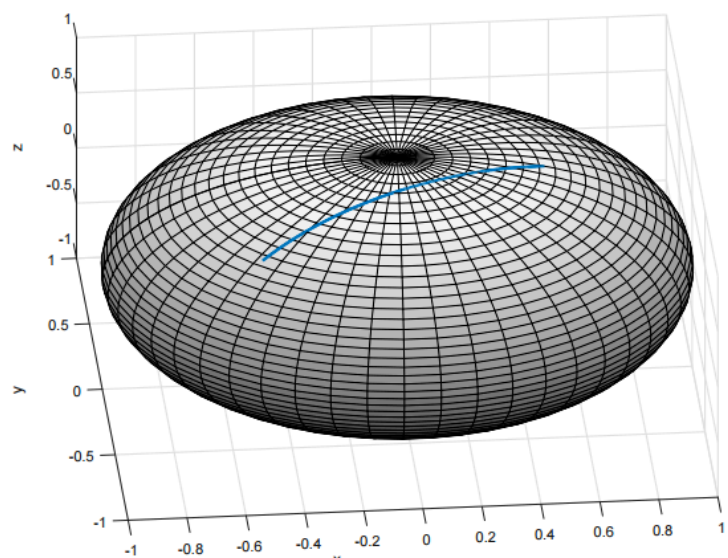

Multi-exponential Lifetime Extraction in Time-logarithmic Scale

Citation: Knyazev, A.; Gao, Q.; Teo, K.H., “Multi-exponential Lifetime Extraction in Time-logarithmic Scale”, *Industrial Conference on Data Mining (ICDM)*, DOI: 10.1007/978-3-319-41561-1_21, vol. 9728, pp. 282-296, July 2016
 Contact: Andrew Knyazev, Koon H. Teo

Methods are proposed for estimating real lifetimes and corresponding coefficients from real-valued measurement data in logarithmic scale, where the data are multi-exponential, i.e. represented by linear combinations of decaying exponential functions with various lifetimes. Initial approximations of lifetimes are obtained as peaks of the first derivative of the data, where the first derivative can, e.g. be calculated in the spectral domain using the cosine Fourier transform. The coefficients

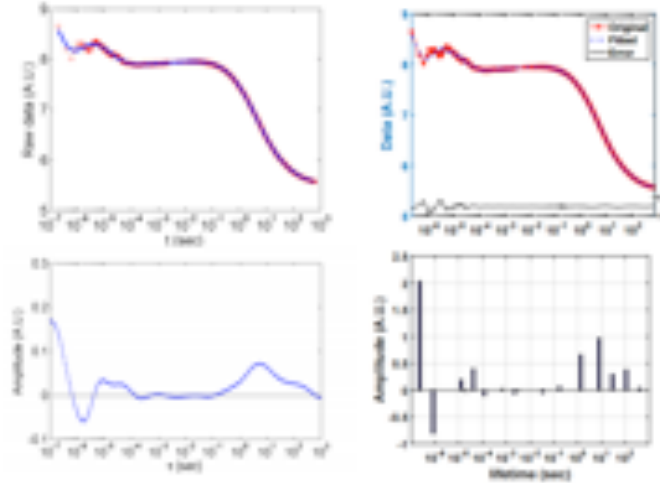

corresponding to lifetimes are then estimated using the linear least squares fitting. Finally, all the coefficients and the lifetimes are optimized using the values previously obtained as initial approximations in the non-linear least squares fitting.

Sparse Preconditioning for Model Predictive Control

Citation: Knyazev, A.; Malyshev, A., “Sparse Preconditioning for Model Predictive Control”, *American Control Conference (ACC)*, DOI: 10.1109/ACC.2016.7526060, pp. 4494-4499, July 2016
 Contact: Andrew Knyazev

We propose fast $O(N)$ preconditioning, where N is the number of gridpoints on the prediction horizon, for iterative solution of (non)-linear systems appearing in model predictive control methods such as forward-difference Newton-Krylov methods. The Continuation/GMRES method for nonlinear model predictive control, suggested by T. Ohtsuka in 2004, is a specific application of the Newton-Krylov method, which uses the GMRES iterative algorithm to solve a forward difference approximation of the optimality equations on every time step.

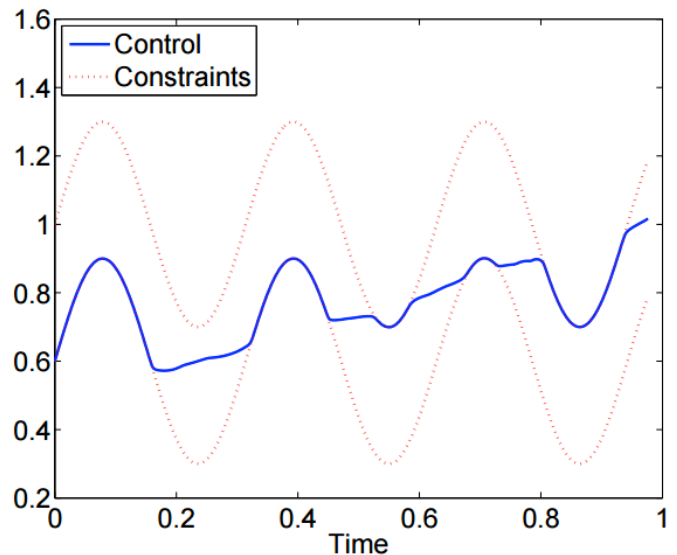

Accelerated Graph-based Nonlinear Denoising Filters

Citation: Knyazev, A.; Malyshev, A., “Accelerated Graph-based Nonlinear Denoising Filters”, *International Conference on Computational Science (ICCS)*, DOI: 10.1016/j.procs.2016.05.348, vol. 80, pp. 607-616, June 2016.

Contact: Andrew Knyazev

Denoising filters, such as bilateral, guided, and total variation filters, applied to images on general graphs may require repeated application if noise is not small enough. We formulate two acceleration techniques of the resulting iterations: conjugate gradient method and Nesterov's acceleration. We numerically show efficiency of the accelerated nonlinear filters for image denoising and demonstrate 2-12 times speed-up, i.e., the acceleration techniques reduce the number of iterations required to reach a given peak signal-to-noise ratio (PSNR) by the above indicated factor of 2-12.

