

**Mitsubishi Electric Research Laboratories (MERL)**

# **Annual Report**

**April 2021 through March 2022**

**TR2022-000**

(Published December 2022)

Welcome to Mitsubishi Electric Research Laboratories (MERL), the North American corporate R&D arm of Mitsubishi Electric Corporation. In this report, you will find descriptions of MERL and our projects.

This work may not be copied or reproduced in whole or in part for any commercial purpose. Permission to copy in whole or in part without payment of fee is granted for nonprofit educational and research purposes provided that all such whole or partial copies include the following: a notice that such copying is by permission of Mitsubishi Electric Research Laboratories; an acknowledgment of the authors and individual contributions to the work; and all applicable portions of the copyright notice. Copying, reproduction, or republishing for another purpose shall require a license with payment of fee to Mitsubishi Electric Research Laboratories. All rights reserved.

Copyright © Mitsubishi Electric Research Laboratories, 2022  
201 Broadway, Cambridge, Massachusetts 02139  
617.621.7500

**Production:**

Thomas Harrington, Richard C. Waters

# Table of Contents

- Mitsubishi Electric Research Laboratories..... 1
- Awards and Commendations..... 7
- Staff ..... 9
- Publications ..... 25
- Research..... 39
  - Media Intelligence ..... 41
  - Robotics ..... 47
  - Optimization & Data Analytics ..... 53
  - Connectivity & Information Processing..... 59
  - Computational Sensing ..... 65
  - Control for Autonomy ..... 71
  - Electric Machines & Devices ..... 77
  - Multi-physical Systems ..... 83



# Mitsubishi Electric Research Laboratories

Mitsubishi Electric Research Laboratories (MERL) is the US subsidiary of the corporate research and development organization of Mitsubishi Electric Corporation. MERL conducts application-motivated basic research and advanced development in: Physical Modelling & Simulation, Signal Processing, Control, Optimization, and Artificial Intelligence. The main body of this report presents our recent research in these areas.

MERL's mission—our assignment from Mitsubishi Electric:

- Generating new technology and intellectual property in areas of importance to Mitsubishi Electric.
- Impacting Mitsubishi Electric's business significantly: using our technical expertise in partnership with organizations in Mitsubishi Electric to produce new and improved products in Mitsubishi Electric's main areas of business.

MERL's vision—our goal for ourselves:

- Being a premiere research laboratory, doing long-term fundamental research that advances the frontiers of technology and makes lasting impacts on the world.
- Being the prime source of technology for Mitsubishi Electric in our areas of expertise.

MERL's values—how we operate:

- Recruiting the highest-quality researchers and developing them into leaders in their fields, encouraging everyone to be a principal investigator and pursue their passions.
- Fostering interdisciplinary teamwork inside MERL with our colleagues at Mitsubishi Electric, and with interns and universities.
- Participating in the world research community, publishing our work while maintaining the confidentiality of business information.
- Combining nimble bottom-up research direction setting with stable long-term support from our large parent organization.
- Enabling researchers to both extend the frontier of science and make real products happen through the large and capable engineering workforce of Mitsubishi Electric.
- Providing excellent benefits and a flexible work environment.

This annual report is a snapshot of MERL's web site. For additional and updated information please visit "[www.merl.com](http://www.merl.com)".

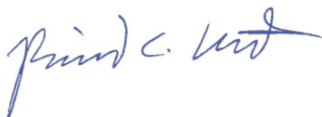

Richard C. Waters  
President, MERL

# MERL Organization

MERL is organized as six groups centered on technology areas, which collaborate closely to achieve groundbreaking results. We use a relatively flat organization to enhance the opportunities for collaboration within MERL. The six members of the top management team work closely together, guiding all aspects of MERL’s operation.



**Richard C. (Dick) Waters** *Ph.D., MIT, 1978*  
 President, CEO & MERL Fellow, ACM Distinguished Scientist  
 Dick Waters received his Ph.D. in Artificial Intelligence (AI). For 13 years he worked at the MIT AI Lab as a Research Scientist and co-principal investigator of the Programmer’s Apprentice project. Dick was a founding member of MERL’s Research Lab in 1991. At MERL, his research centered on multi-user interactive environments for work, learning, and play. In 1999, he became CEO of MERL as a whole.



**Shinsuke Azuma** *M.Eng., The University of Tokyo, 1989*  
 Executive Vice President & CFO  
 Shinsuke (Shin) Azuma joined Mitsubishi Electric in 1989 and worked on the development of small business computers and database processors. In 2000, the DIAPRISM database processor he helped develop set a world record in the sort benchmark contest. Before joining MERL in 2021, he was the general manager of the Information Technology Laboratory in Mitsubishi Electric's Information Technology R&D Center.

**Anthony Vetro** *Ph.D., Polytechnic U. (now part of NYU), 2001*  
Vice President & Director, IEEE Fellow



Anthony joined MERL in 1996 and conducted research in the area of multimedia signal processing. He has contributed to the transfer and development of several technologies to digital television, surveillance, automotive, and satellite imaging systems. He has been an active participant in video coding standards and has also served in various leadership roles for conferences, technical committees and editorial boards. He joined MERL's top management in 2014.

**Philip V. Orlik** *Ph.D., State University of NY at Stony Brook, 1999*  
Vice President & Director



Prior to joining MERL in 2000, Phil worked as a simulation engineer for the MITRE Corporation. His current research interests include wireless communications and networking, signal processing for communication systems, queuing theory, and analytical modeling. He has been an active participant in communication standards

**Elizabeth Phillips** *B.A., University of Massachusetts Amherst, 1988*  
Vice President & Director, Human Resources & Administration



Elizabeth has over 25 years of human resources experience. For 12 years before joining MERL in 2014 she was the principal of a boutique human resources consulting firm in New England, which supported small to mid-size companies with all aspects of their employee related needs. Engagements included: on-site HR leadership, development of talent management programs, management of total rewards programs, facilitation of employee development programs, and HR compliance and administration.

**Jinyun Zhang** *Ph.D., University of Ottawa, 1991*  
Advisor, MD Group Manager, MERL Fellow, IEEE Fellow



Before joining MERL in 2001, Jinyun worked for Nortel Networks for 10 years where she held engineering and management positions in the areas of VLSI design and advanced wireless & optical technology development. She joined MERL's management in 2001. In recognition of her contributions to broadband wireless transmission and networking technology she became an IEEE Fellow in 2008.

# Mitsubishi Electric

One of the world’s largest companies, Mitsubishi Electric Corporation has \$38 billion in annual sales, \$2.1 billion in operating profits (in the year ending in March 2022) and more than 145,000 employees around the world (see [www.mitsubishielectric.com](http://www.mitsubishielectric.com)).

Mitsubishi Electric is composed of a wide range of operations. The primary business units are listed below.



Together, these ten business units produce most of Mitsubishi Electric’s revenue. Due to the wide applicability of MERL’s research, MERL works with them all.

It is worthy of note that there are over 30 major independent companies in the world that use the word “Mitsubishi” in their names. These companies include Mitsubishi UFJ Financial Group, Mitsubishi Corporation, Mitsubishi Heavy Industries, Mitsubishi Chemical Holdings and Mitsubishi Motors, all of which are also among the world’s largest companies. They have shared roots in 19th century Japan; however, they have been separated for many years and Mitsubishi Electric has been separate from all of them since its founding in 1921.



# Mitsubishi Electric’s US Operations

A significant part of Mitsubishi Electric’s sales are in North America and many of Mitsubishi Electric’s business units have North American subsidiaries. The largest US operations are listed below (see [www.mitsubishielectric-usa.com](http://www.mitsubishielectric-usa.com)).

- Mitsubishi Electric Automotive America, Inc.** (Detroit MI & Mason OH)  
 Alternators, Ignition Coils, Automotive Electronics
- Mitsubishi Electric Power Products, Inc.** (Pittsburgh PA)  
 Power Transmission Products, Rail Transportation Systems
- Mitsubishi Electric USA, Inc.** (Los Angeles CA & other cities)  
 Air Conditioners, Elevators, High Power Semiconductors
- Mitsubishi Electric Automation, Inc.** (Chicago IL)  
 Factory Automation Equipment
- Iconics, Inc.** (Boston MA)  
 Real-time visualization, HMI/SCADA, energy management and fault detection software

# Mitsubishi Electric Corporate R&D

Mitsubishi Electric has a global R&D network comprising five laboratories and is the second largest filer of international patents in the world. The chart below summarizes the primary activities of these labs. MERL collaborates with all of these labs.

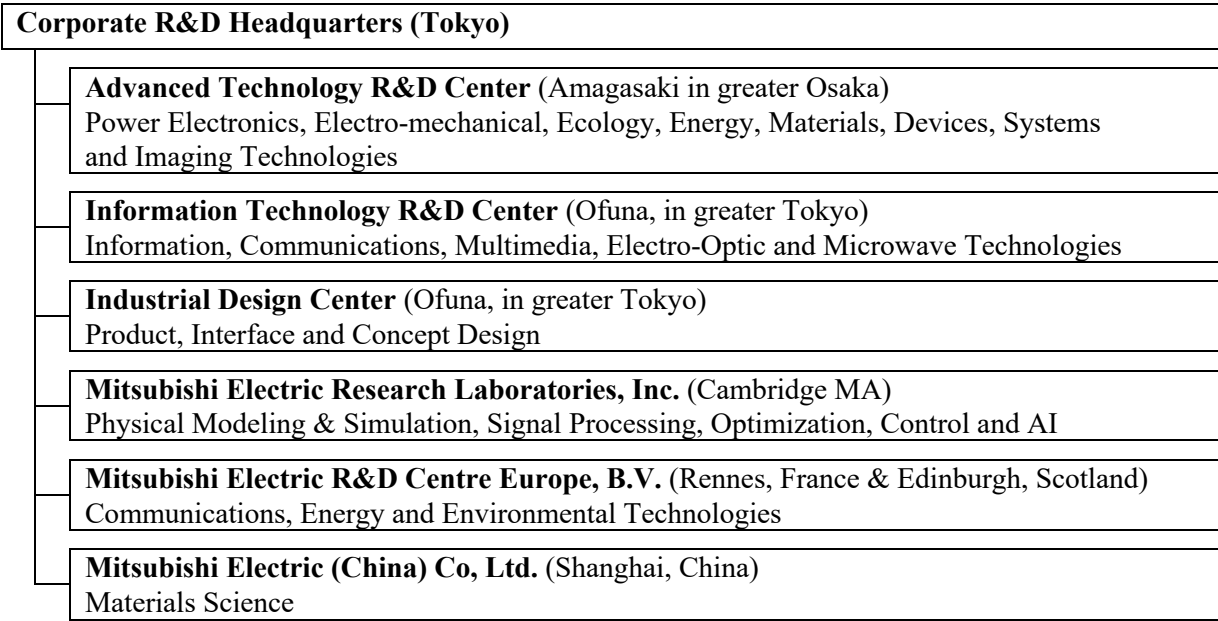



## Awards and Commendations

The high caliber of MERL's research and researchers is evident in a variety of ways. Two are highlighted below. The first is the members of our staff who are Fellows of technical societies. The second is best paper and other awards received from outside organizations. Listed below are awards for the period of this Annual Report.

### Current Technical Society Fellows

Dr. Petros Boufounos - Fellow, Institute of Electrical and Electronic Engineers  
Dr. Toshiaki Koike-Akino - Fellow, Optica (formerly Optical Society of America)  
Dr. Anthony Vetro - Fellow, Institute of Electrical and Electronic Engineers  
Dr. Jin Zhang - Fellow, Institute of Electrical and Electronic Engineers

### Awards and Major Events

MERL's work IoT communication Standardization (see Nagai, Y., Guo, J., Orlik, P.V., Sumi, T., Rolfe, B.A. Mineno, H., "Sub-1 GHz Frequency Band Wireless Coexistence for the Internet of Things", *IEEE Access*, Vol. 9, September 2021) won multiple awards including the 33rd ARIB Radio Achievement Award and the 37th Telecommunications Advancement Foundation Award.

In November 2021, the MERL Signal Processing group achieved first place in the cross-subject transfer learning task and fourth place overall in the NeurIPS 2021 BEETL AI Challenge for EEG Transfer Learning.

The Elevators and Escalators Division of Mitsubishi Electric US, Inc. was recognized as a 2022 CES® Innovation Awards honoree for its new PureRide™ Touchless Control for elevators, jointly developed with MERL.

MERL researcher Joshua Rapp won the 2021 Best PhD Dissertation Award from the IEEE Signal Processing Society. The award recognizes a PhD thesis completed on a signal processing subject within the past three years for its relevant work in signal processing while stimulating further research in the field.

It is worthy of note that MERL had a large number of papers in some of the most selective and prestigious conferences related to MERL's areas of research: 10 papers in the IEEE International Conference on Acoustics, Speech, and Signal Processing (ICASSP), 7 papers in the American Control Conference (ACC), 7 papers in the IEEE Conference on Decision and Control (CDC), 4 papers in the IEEE International Conference on Robotics and Automation (ICRA), and 4 papers in the Annual Conference of the International Speech Communication Association (Interspeech).



## Staff

By providing a highly productive, collaborative environment, MERL believes that it is more than the sum of its parts; however, there is no question that its only important parts are its people. The following pages present the capabilities and interests of MERL's staff members as of the end of the period of this report. Additional information about their work can be found in the publications list and descriptions later in this report.



**Jose Amaya** *Northern Essex Community College*  
Systems & Network Administrator

Jose has over 15 years' experience in various IT support roles in system administration and technical training. His primary interests are working with different open-source technologies and research computing services. Northern Essex Community College graduate, certified in computer networking.



**Luigi (Lou) Baccari** *B.S., University of Massachusetts of Lowell*  
Manager Computational & Network Services & Purchasing

Lou has 23 years of experience in the System and Network Administrations field. For the 6 years prior to joining MERL he worked at HP/Compaq's Cambridge Research Labs providing System and Network. Previous to that he worked for Force Computers, Lycos and Digital Equipment Corp. as Data Center Manager and in various System/Network Support roles.



**Mouhacine Benosman** *Ph.D., Ecole Centrale de Nantes, 2002*  
Senior Principal Research Scientist

Before coming to MERL in 2010, Mouhacine worked at universities in Rome, Italy, Reims, France and Glasgow, Scotland before spending 5 years as a Research Scientist with the Temasek Laboratories at the National University of Singapore. His research interests include modeling and control of flexible systems, non-linear robust and fault tolerant control, vibration suppression in industrial machines and multi-agent control with applications to smart-grid.



**Karl Berntorp** *Ph.D., Lund University, 2014*  
Principal Research Scientist

Karl's doctoral research addressed development of particle-filtering methods, and sensor fusion and optimal control applied to vehicles and robots. His research interests are in nonlinear estimation and control, path planning, motion control, and their applications to automotive, robotics, and aerospace systems.



**Scott A. Bortoff** *Ph.D., University of Illinois Urbana-Champaign, 1992*  
Distinguished Research Scientist, Strategic Project Leader

Scott's research interests are in applications of nonlinear and optimal control theory to motion control, path planning and process control problems. Before joining MERL in 2009, Scott led the Controls Group at the United Technology Research Center and previously was an Associate Professor at the University of Toronto.



**Petros T. Boufounos** *Sc.D., Massachusetts Institute of Technology, 2006*  
Senior Principal Research Scientist, Team Leader

Petros was a Postdoctoral associate at Rice until Jan. 2009, when he joined MERL. Since joining MERL, Petros has contributed in areas such as high-speed video acquisition, ultrasonic imaging, and privacy-preserving secure embeddings. His interests include signal acquisition and processing, signal representations and compressive sensing. He is also a visiting scholar at Rice University and an Associate Editor of IEEE Signal Processing Letters.



**Matthew E. Brand** *Ph.D., Northwestern University, 1994*  
MERL Fellow

Matt develops and analyzes optimization algorithms for problems in logistics, control, perception, data mining, and learning. Notable results include methods for parallel solution of quadratic programs, recomposing photos by re-arranging pixels, nonlinear dimensionality reduction, online singular value decomposition, 3D shape-from-video, and learning concise models of data.



**Ankush Chakrabarty** *Ph.D., Purdue University, 2016*  
Research Scientist

At Purdue, Ankush's research focused on developing scalable, data-driven methods for simplifying computationally intensive operations encountered in controlling and observing complex, nonlinear systems. Prior to joining MERL, Ankush was a postdoctoral Fellow at Harvard where he designed embedded model predictive controllers and deep learning-assisted control strategies for treating people with type 1 diabetes.



**Anoop Cherian** *Ph.D., University of Minnesota, 2013*  
Principal Research Scientist

Anoop was a postdoctoral researcher in the LEAR group at Inria 2012-2015 where his research was on the estimation and tracking of human poses in videos. 2015-2017, he was a Research Fellow at the Australian National University, where he worked on recognizing human activities in video. Currently, his research focus is on modeling the semantics of video data.



**Radu Corcodel** *Ph.D., University of Connecticut, 2017*  
Research Scientist

Radu's PhD focused on workspace analysis and motion synthesis for arbitrary kinematic chains, with particular emphasis on robotic 3D printing and Fusion Deposition Modeling. Currently his research focuses on motion planning and workspace analysis for over-actuated kinematic linkages and collaborative robots.



**Marissa Deegan** *M.B.A., Southern New Hampshire University, 2018*  
HR Generalist, Administrator

Marissa joined MERL in 2015. She has experience in various fields as coordinators of customer service and administration departments. Previously, she worked as a Coordinator of Customer Service and Administration in a soccer company for children. Her interests are in human resource management.



**Stefano Di Cairano** *Ph.D., University of Siena, 2008*  
Senior Principal Research Scientist, Senior Team Leader

Stefano's interests are model predictive control, constrained control, networked control systems, optimization algorithms, stochastic systems, and their applications to automotive, aerospace, logistics, and factory automation. Stefano is a member of the IEEE CSS Conference Editorial Board, and the Chair of the IEEE CSS Technical Committee on Automotive Controls.



**Abraham M. Goldsmith** *M.S., Worcester Polytechnic Institute, 2008*  
Principal Research Scientist

At WPI, Abraham researched 3D ultrasound imaging, particularly the reconstruction of 3D volumes from sequences of 2D images. At MERL he has worked in areas ranging from wireless sensor networks to optical metrology and control of electro-mechanical systems. In addition, Abraham provides electrical and mechanical engineering support to the entire laboratory.



**Jianlin Guo** *Ph.D., University of Windsor, 1995*  
Senior Principal Research Scientist

Jianlin worked at Waterloo Maple as a software developer before joining MERL in 1998. His primary research interests include reliable wireless networks, SmartGrid systems, vehicular communications, broadband wireless communications, and embedded systems.



**Varun Haritsa** M.S., North Carolina State University, 2020  
Visiting Associate Research Scientist

Varun has worked on computer vision projects for applications such as autonomous driving, automated material handling and video anomaly detection. His interests are focused on artificial intelligence including computer vision, deep learning and robotics.



**Chiori Hori** *Ph.D., Tokyo Institute of Technology, 2002*  
Senior Principal Research Scientist

Prior to joining MERL in 2015, Chiori spent 8 years at Japan's National Institute of Information and Communication Technology (NICT), rising to research manager of the Spoken Language Communication Lab. Chiori's work has focused on speech summarization/translation, spoken dialog technology, and standardization of speech interface communication protocols.



**Takaaki Hori** *Ph.D., Yamagata University, 1999*  
Senior Principal Research Scientist

Before joining MERL in 2015, Takaaki spent 15 years doing research on speech and language technology at Nippon Telegraph, and Telephone in Japan. His work includes speech recognition algorithms using weighted finite-state transducers (WFSTs), efficient search algorithms for spoken document retrieval, spoken language understanding, and automatic meeting analysis.



**Frederick J. Igo, Jr.** *B.A., Le Moyne College, 1982*  
Senior Principal Member Research Staff

Fred's professional interests are in software development and its process. He joined MERL in 1985 and has worked on various software technologies, including Distributed Computing, Distributed OLTP, Message Queuing, Mobile Agents, Data Mining, ZigBee, reliable wireless protocols and web development. Prior to joining MERL Fred worked at IPL Systems.



**Teruaki Ito** M.S., Carnegie Mellon University, 2003  
Liaison Manager

Teruaki joined Mitsubishi Electric in 1994 and worked on research and development of computer networks and industrial networks. He is an architect of the CC-Link IE families, an ethernet-based industrial network, used in factory automation systems. Prior to joining MERL, he worked at the Information Technology R&D center of Mitsubishi Electric Corporation as a senior manager of the network technology group.





**Siddarth Jain** *Ph.D., Northwestern University, 2019*  
Visiting Research Scientist

Siddarth's research lies at the intersection of robotics, computer vision, and machine learning. Prior to joining MERL in 2019, he was affiliated with the Shirley Ryan AbilityLab, Chicago (nation's top ranked physical medicine and rehabilitation research hospital). Currently, Siddarth's research focuses on the core challenges in active perception, robotic manipulation, autonomy, and human-robot interaction.



**Devesh Jha** *Ph.D., Pennsylvania State University, 2016*  
Principal Research Scientist

Devesh's PhD Thesis was on decision & control of autonomous systems. He also got a Master's degree in Mathematics from Penn State. His research interests are in the areas of Machine Learning, Time Series Analytics and Robotics. He was a recipient of the best student paper award at the 1st ACM SIGKDD workshop on Machine Learning for Prognostics and Health Management at KDD 2016, San Francisco.



**Michael J. Jones** *Ph.D., Massachusetts Institute of Technology, 1997*  
Senior Principal Research Scientist

Mike's main interest is in computer vision, machine learning and data mining. He has focused on algorithms for detecting and analyzing people in images and video including face detection/recognition and pedestrian detection. He is co-inventor of the popular Viola-Jones face detection method. Mike received the Marr Prize at ICCV and the Longuet-Higgins Prize at CVPR.



**Uros Kalabic** *Ph.D., University of Michigan, 2015*  
Principal Research Scientist

Uros works on advancements in the theory of predictive control and constrained control, as well as its applications to the control of automotive and aerospace systems. His dissertation dealt with theoretical developments and practical applications of reference governors. Prior to joining MERL, Uros interned at MERL and at Ford Motor Company.



**Kyeong Jin Kim** *Ph.D., University of California Santa Barbara, 2000*  
Senior Principal Research Scientist

Kyeong Jin's research interests include transceiver design, performance analysis of spectrum sharing systems, design of cooperative communication systems. Since joining MERL, he has contributed in areas such as reliable communications and E-WLAN system. Currently he is an Associate Editor of IEEE Communications Letters.



**Toshiaki Koike-Akino** *Ph.D., Kyoto University, 2005*  
Senior Principal Research Scientist

Prior to joining MERL in 2010, Toshiaki was a postdoctoral researcher at Harvard University. His research interests include signal processing, cooperative communications, coding theory, and information theory. He received best paper awards at IEEE GLOBECOM in 2008 and 2009.



**Keisuke Kojima** *Ph.D., University of Tokyo, 1990*  
Distinguished Research Scientist

During his 8 years at the Central Research Laboratory, Mitsubishi Electric Corp. (Amagasaki, Japan), and 13 years AT&T/Lucent Bell Laboratories and other major US companies, Keisuke worked on R&D of semiconductor lasers and optical systems as a technical staff and later as a manager. At MERL he is currently working on simulations of optical devices and systems. He has more than 100 publications in journals and conference proceedings.



**Christopher Laughman** *Ph.D., Massachusetts Institute Technology, 2008*  
Senior Principal Research Scientist, Senior Team Leader

Christopher's interests lie in the intersection of the modeling of physical systems and the experimental construction and testing of these systems, including simulation, numerical methods, and fault detection. He has worked on a variety of multi-physical systems, such as thermo-fluid systems and electromechanical energy conversion systems.



**Jonathan Le Roux** *Ph.D., University of Tokyo, 2009*  
Senior Principal Research Scientist, Senior Team Leader

Jonathan completed his B.Sc. and M.Sc. in Mathematics at the Ecole Normale Supérieure in Paris, France. Before joining MERL in 2011, he spent several years in Beijing and Tokyo. In Tokyo he worked as a postdoctoral researcher at NTT's Communication Science Laboratories. His research interests are in signal processing and machine learning applied to speech and audio.



**Chungwei Lin** *Ph.D., Columbia University, 2008*  
Principal Research Scientist

Before joining MERL, Chungwei was a postdoctoral researcher in the Physics Department of the University of Texas at Austin. His particular interest is the use of doping/interface to control optical, thermal, and transport properties. He has worked on the theory of self-assembly, configuration interaction quantum impurity solvers, and photoemission spectroscopy.



**Dehong Liu** *Ph.D., Tsinghua University, 2002*  
Senior Principal Research Scientist

Prior to joining MERL in 2010, Dehong worked at Duke University as a post-doctoral Research Associate (2003-2008), Research Scientist (2008-2010) and Sr. Research Scientist (2010). His main research interests include compressive sensing, signal processing and machine learning.



**Suhas Lohit** *Ph.D., Arizona State University, 2019*  
Visiting Research Scientist

Before coming to MERL, Suhas worked as an intern at MERL (summer 2018), SRI International (summer 2017) and Nvidia (summer 2016). His research interests include computer vision, computational imaging and deep learning. Recently, his research focus has been on creating hybrid model- and data-driven neural architectures for various applications in imaging and vision.



**Rui Ma** *Ph.D., University of Kassel, 2009*  
Senior Principal Research Scientist

Prior to joining MERL, Rui was a Senior Power Amplifier Research Engineer at Nokia Siemens Networks. His research interests include RF Power Device Modeling, Power Amplifier / Radio Front-End Architectures, non-linear microwave circuit design and high frequency measurement techniques.



**Yanting Ma** *Ph.D., North Carolina State University, 2017*  
Research Scientist

Yanting's research interests are mainly in algorithm design and analysis for inverse problems arising in computational sensing using statistical inference and optimization techniques. Her PhD research focused on algorithmic and theoretical studies of approximate message passing, as well as provably convergent optimization algorithms for nonlinear diffractive imaging. Her postdoctoral work developed principled methods for dead time compensation for single-photon detectors based on Markov chain modeling.



**Hassan Mansour**, *Ph.D. University of British Columbia, 2009*  
Senior Principal Research Scientist

Hassan's research interests are in video compression, video transmission and compressed sensing. His PhD research developed resource allocation schemes for the transmission of scalable video content over bandwidth constrained wireless networks. Subsequent work developed adaptive sparse recovery algorithms for correlated signals from compressive measurements.



**Tim K. Marks** *Ph.D., University of California San Diego, 2006*  
Senior Principal Research Scientist

Prior to joining MERL's Imaging Group in 2008, Tim did postdoctoral research in robotic Simultaneous Localization and Mapping in collaboration with NASA's Jet Propulsion Laboratory. His research at MERL spans a variety of areas in computer vision and machine learning, including face recognition under variations in pose and lighting, and robotic vision and touch-based registration for industrial automation.



**Kathleen McCarthy** *B.A., Boston College, 1992*  
Controller

Kathleen has worked for over 30 years in the accounting field with experience in general accounting, payroll and property management. Prior to joining MERL in 1993, she worked in manufacturing, financial and service industries.



**Marcel Menner** *Ph.D., ETH Zurich, 2020*  
Visiting Research Scientist

Marcel's research interests include optimization-based control, machine learning, learning from human interactions, as well as their applications to vehicles and robots. During his Ph.D. research, he developed data-based control methodologies for improving the operation of dynamical systems.



**Francis Morales** *B.S., Universidad APEC (Dominican Republic), 2007*  
Systems & Network Administrator

Francis has been in the IT field since 2001 with experience in different IT industries with special interest in OSs, Networking and Security. Prior to joining MERL he worked 4 years in the healthcare IT field. Previous to that, he was the principal of a small Computer Service business in his home country.



**Niko Moritz** *Ph.D., University of Oldenburg, 2016*  
Visiting Research Scientist

Niko's research interests are in automatic speech recognition and machine learning with application to acoustic events and speech. Prior to joining MERL in 2018, Niko spent 9 years at the Hearing, Speech and Audio (HSA) Technology branch of the Fraunhofer IDMT in Oldenburg (Germany) doing R&D to build automatic speech recognition systems.



**Saleh Nabi** *Ph.D., University of Alberta, 2014*  
Principal Research Scientist

Saleh's research interests are analytical, numerical and similitude experimental modeling of fluid flow and heat transfer in complex systems. His ambition is to derive reduced order models for turbulent buoyancy-driven flows in confined regions to reduce the simulation run time by several orders of magnitude. Saleh's doctoral research mainly focused on environmental and architectural fluid mechanics applied to airflow modeling.



**Daniel N. Nikovski** *Ph.D., Carnegie Mellon University, 2002*  
Data Analytics Group Manager

Dan's research is focused on algorithms for reasoning, planning, and learning with probabilistic models. His current work is on the application of such algorithms to hard transportation problems such as group elevator control and traffic prediction. He also has varied interests in the field of data mining.



**Norihiro Nishiuma** *M.Eng., The University of Tokyo, 1999*  
Liaison Manager

Nori joined Mitsubishi Electric in 1999 working as a researcher in the area of Intelligent Transport Systems (ITS) including road infrastructure and automotive navigation systems. Then, he engaged in product development as a software engineer for automotive equipment in the Sanda Works. Before joining MERL, he was a member of the Systems Technology Dept. in the Advanced Technology R&D Center.



**Carlos J. Nohra** *Ph.D., Carnegie Mellon University, 2020*  
Visiting Research Scientist

Carlos' research focuses on the development of algorithms and software for mixed-integer nonlinear programs, with applications in electric power grids and heat exchanger design.



**Abraham P. Vinod** *Ph.D., University of New Mexico Albuquerque, 2018*  
Research Scientist

Abraham's Ph.D. research developed scalable algorithms for providing safety guarantees for stochastic, control-constrained, dynamical systems. His research work has been applied in motion planning under uncertainty, spacecraft rendezvous planning, and human-automation interactions. His current research interests lie in the intersection of optimization, control, and learning.



**Kieran Parsons** *Ph.D., University of Bristol, UK, 1996*  
Senior Principal Research Scientist, Senior Team Leader

Kieran spent 12 years in Canada working at Nortel, BelAir Networks and AMCC on the system design of several wireless and optical technologies, including early work on electronic dispersion compensation for optical links. His research interests include optical communications network architecture and digital signal processing algorithms for coherent optical communications.



**Kuan-Chuan Peng** *Ph.D., Cornell University, 2016*  
Principal Research Scientist

Before joining MERL, Kuan-Chuan was a Research Scientist (2016-2018) and Staff Scientist (2019) at Siemens Corporate Technology. In addition to his PhD, he received Bachelor's and Master's degrees from National Taiwan University in 2009 and 2012 respectively. His research interests include incremental learning, developing practical solutions given biased or scarce data, and fundamental computer vision and machine learning problems.



**Ronald N. Perry** *B.Sc., Bucknell University, 1981*  
Distinguished Research Scientist

Ron's fundamental research in computer graphics has resulted in numerous publications, a comprehensive patent portfolio, and the development of several meticulously crafted software and hardware products. Ron is best known for the Saffron Type System. The other highlight of his research is the development of 3D ADFs for CAD related products, including an NC simulation system demonstrating unprecedented precision and compactness.



**Kristin Peterson** *B.S., Towson University, 2007*  
Patent Paralegal

Kristin joined MERL in 2012 as a Patent assistant. Prior to working at MERL she attended Boston University's Paralegal program to support a career change. She previously held a position in hospital finance and was a Realtor in the Maryland metropolitan area. She has a Bachelor of Science degree in Psychology.



**Hongtao Qiao** *Ph.D., University of Maryland, 2014*  
Principal Research Scientist

Prior to his PhD, Hongtao worked at Carrier Corporation developing advanced steady-state computer simulations for HVAC systems. During his PhD, he developed a comprehensive transient modeling framework for thermo-fluid systems to explore complex dynamic characteristics of vapor compression cycles.



**Rien Quirynen** *Ph.D., KU Leuven and University of Freiburg, 2017*  
Principal Research Scientist

Rien's research interests are in model predictive control and moving horizon estimation, numerical algorithms for (nonlinear) dynamic optimization and real-time control applications. His doctoral research was focused on numerical simulation methods with efficient sensitivity propagation for real-time optimal control algorithms.



**Arvind U. Raghunathan** *Ph.D., Carnegie Mellon University, 2004*  
Senior Principal Research Scientist

Arvind's research focuses on optimization algorithms large-scale and mixed integer nonlinear programs with applications in power grid, transportation systems and model-based control of processes. He previously worked at the United Technologies Research Center for 7 years developing optimization algorithms for aerospace, elevator, and energy systems.



**Diego Romeres** *Ph.D., University of Padova, 2017*  
Principal Research Scientist

Diego's research interests are in machine learning, system identification and robotic applications. At MERL he is currently working on applying nonparametric machine learning techniques for the control of robotic platforms. His Ph.D. thesis is about the combination of nonparametric data-driven models and physics-based models in gaussian processes for robot dynamics learning.



**Koji Sakai** *M.S., Kobe University, 2008*  
Liaison Manager

Koji joined Mitsubishi Electric Corporation in 2016 and has been working in the area of Intellectual Property. Prior to joining Mitsubishi Electric in 2016, he worked at Toshiba in the same area.



**Alan Sullivan** *Ph.D., University of California at Berkeley, 1993*  
Computer Vision Group Manager

First at U.C. Berkeley, then at Lawrence Livermore National Laboratory, Alan studied interactions between ultra-high intensity femtosecond lasers and plasmas. Prior to joining MERL in 2007, he worked at a series of start-ups where he developed a novel volumetric 3D display technology. At MERL His research interests include computational geometry and computer graphics.



**Hongbo Sun** *Ph.D., Chongqing University, 1991*  
Senior Principal Research Scientist

Prior to joining MERL in 2010, Hongbo was a principal applications Engineer at Oracle, and a technical architect at SPL WorldGroup. He is a registered Professional Engineer with more than 20 years' experience in technical consulting, product development and research on electrical transmission and distribution system planning, analysis, and automation.



**Koon Hoo Teo** *Ph.D., University of Alberta 1990*  
Senior Principal Research Scientist, Strategic Projects Leader

Koon Hoo was with Nortel for 15 years where he was actively involved in the research and implementation of 3G and 4G wireless systems. His work at MERL includes Cognitive Radio, Game Theory and Wireless Mesh for WiMAX and LTE systems. His current areas of research include Metamaterials, Power Amplifiers and Power Devices.



**Jay E. Thornton** *Ph.D., University of Michigan, 1982*  
Multi-Physical Devices Group Manager

Prior to joining MERL in 2002, Jay worked at Polaroid Corporation for many years on human vision and image science problems concerning color reproduction, image quality, half toning, and image processing. At MERL he has become absorbed in research on vision for robotics, medical imaging, computational photography, computer human observation, dictionary learning, and processing of the 3D world.



**Hironori Tsukamoto** *Ph.D., Tokyo Institute of Technology, 1999*  
Patent Agent

Tsukamoto worked as a research scientist in the area of silicon and compound semiconductor materials/devices at Sony Research Center and Yale University for more than 15 years. Prior to joining MERL, he worked at a Japanese Patent Firm to support US patent practice of Japanese client companies for more than 5 years.



**Jeroen van Baar** *Ph.D., ETH Zurich, 2013*  
Senior Principal Research Scientist, Team leader

Jeroen came to MERL in 1997 as an intern, and was subsequently hired as research associate. He temporarily left MERL to pursue a Ph.D. and returned early 2013. At MERL he has made contributions in the areas of computer graphics, computer vision and computational photography. His interests include 3D reconstruction, medical imaging, GP-GPU for computational photography and computer vision.





**Gene V. Vinokur** *J.D., Suffolk University Law School, 2011*  
Senior Patent Counsel

Gene graduated cum laude with distinction in Intellectual Property law. In addition, he holds advanced degrees in Mechanical Engineering and Computer Science. He is a member of Massachusetts Bar and has been a licensed patent practitioner since 2003.



**Bingnan Wang** *Ph.D., Iowa State University 2009*  
Senior Principal Research Scientist

Bingnan's doctoral work focused on the study of wave propagation in novel electromagnetic materials, including photonic crystals and meta-materials. His research interests include electromagnetics and photonics, and their applications to communications, imaging, and energy systems.



**Hongyu Wang** *Ph.D., Tsinghua University, 2006*  
Visiting Research Scientist

Hongyu's main research interest is electric machine design and analysis, including electromagnetic field, thermal field and mechanical aspects of electric machines, transient processes, steady-state and transient parameter calculations, stability, fault/post-fault operation analysis, and drive system control. Before joining MERL, he worked as a Senior Research Associate at The Ohio State University and previously was an Associate Professor at the North China Electrical Power University.



**Pu Wang** *Ph.D., Stevens Institute of Technology, 2011*  
Principal Research Scientist

Before coming to MERL, Pu was a Research Scientist in the Mathematics and Modeling Department of Schlumberger-Doll Research, contributing to development of logging-while-drilling Acoustic/NMR products. His current research interests include statistical signal processing, Bayesian inference, sparse signal recovery, and their applications to sensing, wireless communications, and networks.

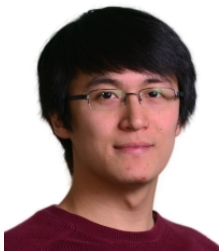

**Ye Wang** *Ph.D., Boston University, 2011*  
Principal Research Scientist

Ye was a member of the Information Systems and Sciences Laboratory at Boston University, where he studied information-theoretically secure multiparty computation. His current research interests include information security, biometric authentication, and data privacy.



**Yebin Wang** *Ph.D., University of Alberta, 2008*  
Senior Principal Research Scientist

Prior to joining MERL, Yebin worked on process control, software development and management, and nonlinear estimation theory for over ten years. Yebin's research interests include nonlinear estimation/control theory and applications, optimal control, adaptive/learning systems, modeling and control of complex systems.



**Avishai Weiss** *Ph.D., University of Michigan, 2013*  
Principal Research Scientist

Avishai's doctoral research was on spacecraft orbital and attitude control. Prior to the University of Michigan, he studied at Stanford University, where he received a B.S. in Electrical Engineering and an M.S. in Aeronautics and Astronautics. Avishai's interests are in constrained control, model predictive control, and time-varying systems.



**Gordon Wichern** *Ph.D., Arizona State University, 2010*  
Principal Research Scientist

Gordon's research interests are at the intersection of signal processing and machine learning applied to speech, music, and environmental sounds. Prior to joining MERL, Gordon worked at iZotope inc. developing audio signal processing software, and at MIT Lincoln Laboratory where he worked in radar target tracking.



**Victoria Wong** *B.S. Bentley College, 2008*  
Principal Staff Accountant

Victoria has over 10 years' experience primarily focusing on accounts payable and payroll. She joined MERL in June, 2008. Prior to joining MERL, she was an intern with Federal Reserve Bank of Boston and EF Education. Her B.S. degree is in Accounting Information Systems.



**William S. Yerazunis** *Ph.D., Rensselaer Polytechnic Institute, 1987*  
Senior Principal Research Scientist

Bill has worked in numerous fields, including parallel computation, SETI, jet engine production, real-time signal processing, expert systems, pattern recognition, text classification, wireless power, and meta-materials. He is the author of the CRM114 spam filter, and was voted one of the 50 most important people in computer network security by Network World magazine.



**Jing Zhang** *Ph.D., Boston University, 2017*  
Research Scientist

Jing's PhD dissertation was on detection and optimization problems with applications in transportation systems. His research interests include anomaly detection, optimization, machine learning, and time series analysis. He was a recipient of the Boston Area Research Initiative (BARI) Research Seed Grant Award (Spring 2017).



## Publications

The following lists the major publications by members of the MERL staff during the period of this report. A publication is considered major if it appeared in a refereed journal, a refereed conference proceeding or some other significant publication such as a book.

Han, M., Ozdenizci, O., Koike-Akino, T., Wang, Y., Erdogmus, D., "**Universal Physiological Representation Learning with Soft-Disentangled Rateless Autoencoders**", *IEEE Journal of Biomedical and Health Informatics*, DOI: 10.1109/JBHI.2021.3062335, ISSN: 2168-2208, Vol. 25, No. 8, pp. 2928-2937, April 2021. ([TR2021-027](#))

Ma, R., Komatsuzaki, Y., Benosman, M., Yamanaka, K., Shinjo, S., "**A New Frontier for Power Amplifier enabled by Machine Learning**", *Microwave Journal*, ISSN: 0192-6225, No. 4, pp. 22-32, April 2021. ([TR2021-030](#))

Wang, F., Wang, P., Zhang, X., Li, H., Himed, B., "**An Overview of Parametric Modeling and Methods for Radar Target Detection with Limited Data**", *IEEE Access*, DOI: 10.1109/ACCESS.2021.3074063, ISSN: 2169-3536, Vol. 9, pp. 60459-60469, April 2021. ([TR2021-049](#))

Koga, S., Benosman, M., Borggaard, J., "**Extremum Seeking-Based Observer Design for Reduced Order Models of Coupled Thermal and Fluid Systems**", *International Journal of Adaptive Control and Signal Processing*, DOI: 10.1002/acs.3252, April 2021. ([TR2021-065](#))

Kalabic, U., Weiss, A., Chiu, M., "**Distributed Small Sat Location Verification**", *Integrated Communications Navigation and Surveillance (ICNS) Conference*, DOI: 10.1109/ICNS52807.2021.9441603, April 2021. ([TR2021-033](#))

Nagai, Y., Sumi, T., Guo, J., Orlik, P.V., Mineno, H., "**IEEE 802.19.3 Standardization for Coexistence of IEEE 802.11ah and IEEE 802.15.4g Systems in Sub-1 GHz Frequency Bands**", *Information Processing Society of Japan/Consumer Device and System Transaction*, Vol. 11, No. 5, May 2021. ([TR2021-035](#))

Chiu, M., Goldsmith, A.M., Kalabic, U., "**Blockchain for Embedded System Accountability**", *IEEE International Conference on Blockchain and Cryptocurrency (ICBC)*, DOI: 10.1109/ICBC51069.2021.9461143, May 2021. ([TR2021-041](#))

Kalabic, U., Weiss, A., Chiu, M., "**Orbit Verification of Small Sat Constellations**", *IEEE International Conference on Blockchain and Cryptocurrency (ICBC)*, DOI: 10.1109/ICBC51069.2021.9461065, May 2021. ([TR2021-040](#))

Pan, C., Chen, S., Ortega, A., "**Spatio-Temporal Graph Scattering Transform**", *International Conference on Learning Representations (ICLR)*, May 2021. ([TR2021-044](#))

Hori, C., Tsuchiya, M., Chen, S., Cherian, A., Hori, T., Harsham, B.A., Marks, T.K., Le Roux, J., Sullivan, A., Vetro, A., "**マルチモーダルセンシング情報に基づく Scene-aware Interaction 技術**", *Society of Automotive Engineers of Japan*, Vol. 75, No. 5, pp. 66-71, May 2021. ([TR2021-042](#))

Fujihashi, T., Koike-Akino, T., Watanabe, T., Orlik, P.V., "**HoloCast+: Hybrid Digital-Analog Transmission for Graceful Point Cloud Delivery with Graph Fourier Transform**", *IEEE Transactions on Multimedia*, DOI: 10.1109/TMM.2021.3077772, ISSN: 1941-0077, May 2021. ([TR2021-043](#))

Kim, S., Galley, M., Gunasekara, C., Lee, S., Atkinson, A., Peng, B., Schulz, H., Gao, J., Li, J., Adada, M., Huang, M., Lastras, L., Kummerfeld, J.K., Lasecki, W.S., Hori, C., Cherian, A., Marks, T.K., Rastogi, A., Zang, X., Sunkara, S., Gupta, R., "**Overview of the Eighth Dialog System Technology Challenge: DSTC8**", *IEEE/ACM Transactions on Audio, Speech, and Language Processing*, DOI: 10.1109/TASLP.2021.3078368, ISSN: 2329-9290, May 2021. ([TR2021-064](#))

Tang, Y., Kojima, K., Koike-Akino, T., Wang, Y., Jha, D.K., Parsons, K., Qi, M., "**Nano-Optic Broadband Power Splitter Design via Cycle-Consistent Adversarial Deep Learning**", *Conference on Lasers and Electro-Optics (CLEO)*, DOI: 10.1364/CLEO\_SI.2021.SW4E.1, May 2021. ([TR2021-045](#))

Lin, C., Ma, Y., Sels, D., "**Optimal Control for Quantum Metrology via Pontryagin's principle**", *Physical Review*, DOI: 10.1103/PhysRevA.103.052607, Vol. 103, No. 5, pp. 052607, May 2021. ([TR2021-067](#))

Zhou, L., Guo, F., Wang, H., Wang, B., "**High-Torque Direct-Drive Machine with Combined Axial- and Radial-flux Out-runner Vernier Permanent Magnet Motor**", *International Electric Machine & Drives Conference (IEMDC)*, DOI: 10.1109/IEMDC47953.2021.9449499, May 2021, pp. 1-8. ([TR2021-050](#))

Zhou, L., Wang, B., Lin, C., Miyoshi, M., Inoue, H., "**Static Eccentricity Fault Detection for PSH-type Induction Motors Considering High-order Air Gap Permeance Harmonics**", *International Electric Machine & Drives Conference (IEMDC)*, DOI: 10.1109/IEMDC47953.2021.9449496, May 2021, pp. 1-7. ([TR2021-051](#))

Laughman, C.R., Qiao, H., "**Patch-based Thermodynamic Property Models for the Subcritical Region**", *Purdue Air-Conditioning and Refrigeration Conference*, May 2021. ([TR2021-053](#))

Bonzanini, A.D., Mesbah, A., Di Cairano, S., "**Perception-Aware Chance-Constrained Model Predictive Control for Uncertain Environments**", *American Control Conference (ACC)*, DOI: 10.23919/ACC50511.2021.9483203, May 2021. ([TR2021-055](#))

Aguilar Marsillach, D., Di Cairano, S., Kalabic, U., Weiss, A., "**Fail-Safe Spacecraft Rendezvous on Near-Rectilinear Halo Orbits**", *American Control Conference (ACC)*, DOI: 10.23919/ACC50511.2021.9483328, ISSN: 2378-5861, ISBN: 978-1-6654-4197-1, May 2021, pp. 2980-2985. ([TR2021-054](#))

Berntorp, K., Chakrabarty, A., Di Cairano, S., "**Vehicle Center-of-Gravity Height and Dynamics Estimation with Uncertainty Quantification by Marginalized Particle Filter**", *American Control Conference (ACC)*, DOI: 10.23919/ACC50511.2021.9483251, May 2021, pp. 160-165. ([TR2021-058](#))

Kalur, A., Nabi, S., Benosman, M., "**Robust Adaptive Dynamic Mode Decomposition for Reduce Order Modelling of Partial Differential Equations**", *American Control Conference (ACC)*, DOI: 10.23919/ACC50511.2021.9483319, ISSN: 2378-5861, ISBN: 978-1-7281-9704-3, May 2021, pp. 4497-4502. ([TR2021-059](#))

Laftchiev, E., Romeres, D., Nikovski, D.N., "**Dynamic Thermal Comfort Optimization for Groups**", *American Control Conference (ACC)*, DOI: 10.23919/ACC50511.2021.9483191, ISSN: 2378-5861, ISBN: 978-1-6654-4197-1, May 2021. ([TR2021-057](#))

Berntorp, K., Quirynen, R., Vaskov, S., "**Joint Tire-Stiffness and Vehicle-Inertial Parameter Estimation for Improved Predictive Control**", *American Control Conference (ACC)*, DOI: 10.23919/ACC50511.2021.9482635, May 2021, pp. 186-191. ([TR2021-060](#))

Vaskov, S., Berntorp, K., Quirynen, R., "**Cornering Stiffness Adaptive, Stochastic Nonlinear Model Predictive Control for Vehicles**", *American Control Conference (ACC)*, DOI: 10.23919/ACC50511.2021.9482699, May 2021, pp. 154-159. ([TR2021-056](#))

Dong, S., Jha, D.K., Romeres, D., Kim, S., Nikovski, D.N., Rodriguez, A., "**Tactile-RL for Insertion: Generalization to Objects of Unknown Geometry**", *IEEE International Conference on Robotics and Automation (ICRA)*, May 2021. ([TR2021-052](#))

Dai, S., Wang, Y., "**Long-Horizon Motion Planning for Autonomous Vehicle Parking Incorporating Incomplete Map Information**", *IEEE International Conference on Robotics and Automation (ICRA)*, DOI: 10.1109/ICRA48506.2021.9562101, May 2021, pp. 8135-8142. ([TR2021-062](#))

Haruna, M., Kawaguchi, N., Ogino, M., Koike-Akino, T., "**Comparison of Three Feedback Modalities for Haptics Sensation in Remote Machine Manipulation**", *IEEE International Conference on Robotics and Automation (ICRA)*, DOI: 10.1109/LRA.2021.3070301, ISSN: 2377-3766, May 2021. ([TR2021-063](#))

Fang, H., Haile, M., Wang, Y., "**Robust Extended Kalman Filtering for Systems with Measurement Outliers**", *IEEE Transactions on Control Systems Technology*, DOI: 10.1109/TCST.2021.3077535, Vol. 30, No. 2, pp. 795-802, May 2021. ([TR2021-078](#))

Hu, W., Chen, S., Tian, D., "**Graph Spectral Point Cloud Processing**" in ISTE Ltd, DOI: 10.1002/9781119850830.ch7, June 2021. ([TR2021-085](#))

Jin, S., Romeres, D., Raghunathan, A., Jha, D.K., Tomizuka, M., "**Trajectory Optimization for Manipulation of Deformable Objects: Assembly of Belt Drive Units**", *IEEE International Conference on Robotics and Automation (ICRA)*, DOI: 10.1109/ICRA48506.2021.9561556, ISSN: 2577-087X, ISBN: 978-1-7281-9077-8, June 2021. ([TR2021-072](#))

Watanabe, S., Boyer, F., Chang, X., Guo, P., Hayashi, T., Higuchi, Y., Hori, T., Huang, W.-C., Inaguma, H., Kamo, N., Shigeki, K., Li, C., Shi, J., Subramanian, A.S., Zhang, W., "**The 2020 ESPNET Update: New Features, Broadened Applications, Performance Improvements, and Future Plans**", *IEEE Data Science and Learning Workshop (DSLW)*, DOI: 10.1109/DSLW51110, ISBN: 978-1-6654-2826-2, June 2021, pp. 1-6. ([TR2021-073](#))

Moritz, N., Hori, T., Le Roux, J., "**Semi-Supervised Speech Recognition via Graph-Based Temporal Classification**", *IEEE International Conference on Acoustics, Speech, and Signal Processing (ICASSP)*, DOI: 10.1109/ICASSP39728.2021.9414058, June 2021, pp. 6548-6552. ([TR2021-037](#))

Khurana, S., Moritz, N., Hori, T., Le Roux, J., "**Unsupervised Domain Adaptation For Speech Recognition via Uncertainty Driven Self-Training**", *IEEE International Conference on Acoustics, Speech, and Signal Processing (ICASSP)*, DOI: 10.1109/ICASSP39728.2021.9414299, June 2021, pp. 6553-6557. ([TR2021-039](#))

Hyder, R., Mansour, H., Ma, Y., Boufounos, P.T., Wang, P., "**A Consensus Equilibrium Solution for Deep Image Prior Powered by Red**", *IEEE International Conference on Acoustics, Speech, and Signal Processing (ICASSP)*, DOI: 10.1109/ICASSP39728.2021.9414290, ISSN: 2379-190X, ISBN: 978-1-7281-7605-5, June 2021, pp. 1380-1384. ([TR2021-046](#))

Chen, S., Eldar, Y., "**Time-Varying Graph Signal inpainting via Unrolling Networks**", *IEEE International Conference on Acoustics, Speech, and Signal Processing (ICASSP)*, DOI: 10.1109/ICASSP39728.2021.9413406, June 2021. ([TR2021-070](#))

Hung, Y.-N., Wichern, G., Le Roux, J., "**Transcription Is All You Need: Learning to Separate Musical Mixtures with Score as Supervision**", *IEEE International Conference on Acoustics, Speech, and Signal Processing (ICASSP)*, DOI: 10.1109/ICASSP39728.2021.9413358, ISSN: 2379-190X, ISBN: 978-1-7281-7605-5, June 2021, pp. 46-50. ([TR2021-069](#))

Chen, S., Eldar, Y., "**Graph Signaling Denoising via Unrolling Networks**", *IEEE International Conference on Acoustics, Speech, and Signal Processing (ICASSP)*, DOI: 10.1109/ICASSP39728.2021.9415073, June 2021. ([TR2021-071](#))

Yao, G., Wang, P., Berntorp, K., Mansour, H., Boufounos, P.T., Orlik, P.V., "**Extended Object Tracking with Automotive Radar Using B-Spline Chained Ellipses Model**", *IEEE International Conference on Acoustics, Speech, and Signal Processing (ICASSP)*, DOI: 10.1109/ICASSP39728.2021.9415080, ISSN: 2379-190X, ISBN: 978-1-7281-7605-5, June 2021, pp. 8408-8412. ([TR2021-048](#))

Shi, L., Liu, D., Umeda, M., Hana, N., "**Fusion-Based Image Correlations Framework For Strain Measurement**", *IEEE International Conference on Acoustics, Speech, and Signal Processing (ICASSP)*, DOI: 10.1109/ICASSP39728.2021.9414987, ISSN: 2379-190X, ISBN: 978-1-7281-7606-2, June 2021. ([TR2021-012](#))

Ma, Y., Boufounos, P.T., Mansour, H., Aeron, S., "**Multiview Sensing with Unknown Permutations: An Optimal Transport Approach**", *IEEE International Conference on Acoustics, Speech, and Signal Processing (ICASSP)*, DOI: 10.1109/ICASSP39728.2021.9415075, ISSN: 1520-6149, ISBN: 978-1-7281-7606-2, June 2021, pp. 1440-1444. ([TR2021-047](#))



Moritz, N., Hori, T., Le Roux, J., "**Capturing Multi-Resolution Context by Dilated Self-Attention**", *IEEE International Conference on Acoustics, Speech, and Signal Processing (ICASSP)*, DOI: 10.1109/ICASSP39728.2021.9415001, June 2021, pp. 5869-5873. ([TR2021-036](#))

Raychaudhuri, D.S., van Baar, J., Paul, S., Roy-Chowdhury, A.K., "**Cross-domain Imitation from Observations**", *International Conference on Machine Learning (ICML)*, June 2021. ([TR2021-074](#))

Kim, K.J., Guo, J., Orlik, P.V., Nagai, Y., Poor, H.V., "**A Cluster-Based Transmit Diversity Scheme for Asynchronous Joint Transmissions in Private Networks**", *IEEE International Conference on Communications (ICC)*, DOI: 10.1109/ICC42927.2021.9500522, June 2021, pp. 1-6. ([TR2021-075](#))

Fujihashi, T., Koike-Akino, T., Chen, S., Watanabe, T., "**Wireless 3D Point Cloud Delivery Using Deep Graph Neural Networks**", *IEEE International Conference on Communications (ICC)*, DOI: 10.1109/ICC42927.2021.9500925, ISSN: 1938-1883, ISBN: 978-1-7281-7122-7, June 2021. ([TR2021-066](#))

Zhang, S., Ye, F., Wang, B., Habetler, T.G., "**Few-Shot Bearing Fault Diagnosis Based on Model-Agnostic Meta-Learning**", *IEEE Transactions on Industry Applications*, DOI: 10.1109/TIA.2021.3091958, June 2021. ([TR2021-081](#))

Dalla Libera, A., Amadio, F., Nikovski, D.N., Carli, R., Romeres, D., "**Control of Mechanical Systems via Feedback Linearization Based on Black-Box Gaussian Process Models**", *European Control Conference (ECC)*, DOI: 10.23919/ECC54610.2021.9654429, ISBN: 978-9-4638-4236-5, June 2021. ([TR2021-068](#))

Li, K., Yagy, E., Sato, H., Teo, K.H., Rakheja, S., "**Compact modeling of gate leakage phenomenon in GaN HEMTs**", *IEEE Transactions on Electron Devices*, DOI: 10.23919/SISPAD49475.2020.9241666, June 2021. ([TR2021-079](#))

Cherian, A., Wang, J., "**Generalized One-Class Learning Using Pairs of Complementary Classifiers**", *IEEE Transactions on Pattern Analysis and Machine Intelligence*, DOI: 10.1109/TPAMI.2021.3092999, June 2021. ([TR2021-076](#))

Koike-Akino, T., Wang, Y., "**Protograph-Based Design for QC Polar Codes**", *IEEE International Symposium on Information Theory (ISIT)*, DOI: 10.1109/ISIT45174.2021.9517868, ISBN: 978-1-5386-8209-8, July 2021. ([TR2021-080](#))

Quirynen, R., Berntorp, K., "**Uncertainty Propagation by Linear Regression Kalman Filters for Stochastic NMPC**", *IFAC Conference on Nonlinear Model Predictive Control*, DOI: 10.1016/j.ifacol.2021.08.527, July 2021, pp. 76-82. ([TR2021-084](#))

Zeng, T., Guo, J., Kim, K.J., Parsons, K., Orlik, P.V., Di Cairano, S., Saad, W., "**Multi-Task Federated Learning for Traffic Prediction and Its Application to Route Planning**", *IEEE Intelligent Vehicles Symposium*, July 2021. ([TR2021-083](#))

Wang, Y., Aeron, S., Rakin, A.S., Koike-Akino, T., Moulin, P., "**Robust Machine Learning via Privacy/Rate-Distortion Theory**", *IEEE International Symposium on Information Theory (ISIT)*, DOI: 10.1109/ISIT45174.2021.9517751, ISBN: 978-1-5386-8210-4, July 2021. ([TR2021-082](#))

Chakrabarty, A., Wichern, G., Laughman, C.R., "**ANP-BBO: Attentive Neural Processes and Batch Bayesian Optimization for Scalable Calibration of Physics-Informed Digital Twins**", *International Conference on Machine Learning (ICML)*, July 2021. ([TR2021-086](#))

Wang, S., Sun, H., Kim, K.J., Guo, J., Nikovski, D.N., "**Solving Bernoulli Bandit Problems for Weather-relative Overhead Distribution Line Failures Forecasting**", *IEEE PES GM*, DOI: 10.1109/PESGM46819.2021.9638153, July 2021. ([TR2021-087](#))

Solomon, E., Yerazunis, W.S., "**Robotic Applications of Mechanical Metamaterials Produced Using SLA 3D Printing: Cthulhu-Morphic Grippers**", *Solid Freeform Fabrication Symposium*, August 2021. ([TR2021-088](#))

Menner, M., Berntorp, K., Di Cairano, S., "**A Kalman Filter for Online Calibration of Optimal Controllers**", *IEEE Conference on Control Technology and Applications (CCTA)*, DOI: 10.1109/CCTA48906.2021.9658684, August 2021, pp. 441-446. ([TR2021-091](#))

Greiff, M., Berntorp, K., Di Cairano, S., Kim, K.J., "**Mixed-Integer Linear Regression Kalman Filters for GNSS Positioning**", *IEEE Conference on Control Technology and Applications (CCTA)*, DOI: 10.1109/CCTA48906.2021.9659142, August 2021. ([TR2021-090](#))

Ravikumar, S., Quirynen, R., Bhagat, A., Zeino, E., Di Cairano, S., "**Mixed-integer Programming for Centralized Coordination of Connected and Automated Vehicles in Dynamic Environment**", *IEEE Conference on Control Technology and Applications (CCTA)*, DOI: 10.1109/CCTA48906.2021.9658675, August 2021, pp. 814-819. ([TR2021-089](#))

Moritz, N., Hori, T., Le Roux, J., "**Dual Causal/Non-Causal Self-Attention for Streaming End-to-End Speech Recognition**", *Annual Conference of the International Speech Communication Association (Interspeech)*, DOI: 10.21437/Interspeech.2021-1693, August 2021, pp. 1822-1826. ([TR2021-094](#))

Hori, C., Hori, T., Le Roux, J., "**Optimizing Latency for Online Video Captioning Using Audio-Visual Transformers**", *Annual Conference of the International Speech Communication Association (Interspeech)*, DOI: 10.21437/Interspeech.2021-1975, August 2021, pp. 586-590. ([TR2021-093](#))

Jain, S., Corcodel, R., van Baar, J., "**Visual 3D Perception for Interactive Robotic Tactile Data Acquisition**", *IEEE International Conference on Automation Science and Engineering (CASE 2021)*, August 2021. ([TR2021-092](#))

Hori, T., Moritz, N., Hori, C., Le Roux, J., "**Advanced Long-context End-to-end Speech Recognition Using Context-expanded Transformers**", *Annual Conference of the International Speech Communication Association (Interspeech)*, DOI: 10.21437/Interspeech.2021-1643, August 2021, pp. 2097-2101. ([TR2021-100](#))

Koike-Akino, T., Wang, Y., "**Evolution of Polar Coding**", *IEEE International Symposium on Topics in Coding (ISTC)*, August 2021. ([TR2021-104](#))

Qiao, H., Laughman, C.R., "**Modeling and Analysis of Pressure Drop Oscillations in Horizontal Boiling Flow**", *International Refrigeration and Air Conditioning Conference at Purdue*, August 2021. ([TR2021-102](#))

Chakrabarty, A., Benosman, M., "**Safe Learning-based Observers for Unknown Nonlinear Systems using Bayesian Optimization**", *Automatica*, DOI: 10.1016/j.automatica.2021.109860, August 2021. ([TR2021-101](#))

Nagai, Y., Guo, J., Orlik, P.V., Sumi, T., Rolfe, B.A. Mineno, H., "**Sub-1 GHz Frequency Band Wireless Coexistence for the Internet of Things**", *IEEE Access*, Vol. 9, September 2021. (TR2022-037)

Chakrabarty, A., Maddalena, E., Qiao, H., Laughman, C.R., "**Data-driven calibration of physics-informed models of joint building/equipment dynamics using Bayesian optimization**", *2021 Building Simulation Conference*, September 2021. ([TR2021-105](#))

Tanaka, R., Nabi, S., Nonaka, M., "**Airflow Optimization for Room Air Conditioners**", *Building Simulation 2021 Conference*, September 2021. ([TR2021-106](#))

Liu, B., Guo, J., Koike-Akino, T., Wang, Y., Kim, K.J., Parsons, K., Orlik, P.V., Hashimoto, S., Yuan, J., "**Anomaly Detection and Diagnosis Using Pre-Processing and Time-Delay Autoencoder**", *IEEE International conference on emerging technologies and factory automation*, September 2021. ([TR2021-107](#))

Haruna, M., Ogino, M., Koike-Akino, T., "**Human x Machine Remote Fusion System: Visual Haptics Implementation**," Tech. Rep., The Robotics Society of Japan (RSJ), September 2021.

Higuchi, Y., Moritz, N., Le Roux, J., Hori, T., "**Momentum Pseudo-Labeling for Semi-Supervised Speech Recognition**", *Annual Conference of the International Speech Communication Association (Interspeech)*, DOI: 10.21437/Interspeech.2021-571, September 2021, pp. 726-730. ([TR2021-103](#))

Amadio, F., Dalla Libera, A., Carli, R., Romeres, D., "**Model-Based Reinforcement Learning Using Monte Carlo Gradient Estimation**", *Automatica.it*, September 2021. ([TR2021-108](#))

Koike-Akino, T., Wang, Y., Kojima, K., Parsons, K., Yoshida, T., "**Zero-Multiplier Sparse DNN Equalization for Fiber-Optic QAM Systems with Probabilistic Amplitude Shaping**", *European Conference on Optical Communication (ECOC)*, DOI: 10.1109/ECOC52684.2021.9605870, ISBN: 978-1-6654-3868-1, September 2021. ([TR2021-110](#))

Skvortcov, P., Millar, D.S., Phillips, I., Forsyia, W., Koike-Akino, T., Kojima, K., Parsons, K., "**Experimental Analysis of Mismatched Soft-Demapping for Probabilistic Shaping in Short-Reach Nonlinear Transmission**", *European Conference on Optical Communication (ECOC)*, DOI: 10.1109/ECOC52684.2021.9605820, ISBN: 978-1-6654-3868-1, September 2021. ([TR2021-109](#))

Skvortcov, P., Koike-Akino, T., Millar, D.S., Kojima, K., Parsons, K., "**Dual Coding Concatenation for Burst-Error Correction in Probabilistic Amplitude Shaping**", *European Conference on Optical Communication (ECOC)*, DOI: 10.1109/ECOC52684.2021.9605842, ISBN: 978-1-6654-3868-1, September 2021. ([TR2021-111](#))

Shi, L., Liu, D., Thornton, J.E., **"Robust Camera Pose Estimation for Image Stitching"**, *IEEE International Conference on Image Processing (ICIP)*, DOI: 10.1109/ICIP42928.2021.9506680, ISBN: 978-1-6654-4115-5, September 2021. ([TR2021-113](#))

Comas, A., Marks, T.K., Mansour, H., Lohit, S., Ma, Y., Liu, X., **"TURNIP: Time-series U-NET with Recurrence for NIR Imaging PPG"**, *IEEE International Conference on Image Processing (ICIP)*, September 2021. ([TR2021-099](#))

Rackaukas, C., Anantharaman, R., Edelman, A., Gowda, S., Gwozdz, M., Jain, A., Laughman, C.R., Ma, Y., Martinuzzi, F., Pal, A., Rajput, U., Saba, E., Shah, V., **"Composing Modeling and Simulation with Machine Learning in Julia"**, *14th International Modelica Conference*, September 2021. ([TR2021-114](#))

Kannapiran, S., van Baar, J., Berman, S., **"A Visual Inertial Odometry Framework for 3D Points, Lines and Planes"**, *IEEE/RSJ International Conference on Intelligent Robots and Systems (IROS)*, DOI: 10.1109/IROS51168.2021.9636526, September 2021. ([TR2021-131](#))

Leonard, E., Qiao, H., Nabi, S., **"A Comparison of Interpolation Methods in Fast Fluid Dynamics"**, *International High Performance Buildings Conference*, September 2021. ([TR2021-118](#))

Matsumine, T., Koike-Akino, T., Ochiai, H., **"A Low-Complexity Probabilistic Amplitude Shaping with Short Linear Block Codes"**, *IEEE Transactions on Communications*, DOI: 10.1109/TCOMM.2021.3111032, ISSN: 1558-0857, Vol. 69, No. 12, pp. 7923-7933, September 2021. ([TR2021-117](#))

Li, S., Qiao, H., **"Development of a fast fluid dynamics model based on PISO algorithm for simulating indoor airflow"**, *ASME - Summer Heat Transfer Conference*, DOI: HT2021-63909, September 2021. ([TR2021-120](#))

Hu, W., Pang, J., Liu, X., Tian, D., Lin, C.-W., Vetro, A., **"Graph Signal Processing for Geometric Data and Beyond: Theory and Applications"**, *IEEE Transactions on Multimedia*, October 2021. ([TR2021-121](#))

Jurdi, R., Guo, J., Kim, K.J., Orlik, P.V., Nagai, Y., **"Queueing Delay Analysis of Mixed Traffic in Time Sensitive Networks"**, *International Conference on Intelligent Manufacturing and Automation Engineering (ICIMA)*, October 2021. ([TR2021-122](#))

Chatterjee, M., Ahuja, N., Cherian, A., **"A Hierarchical Variational Neural Uncertainty Model for Stochastic Video Prediction"**, *IEEE International Conference on Computer Vision (ICCV)*, October 2021, pp. 9751-9761. ([TR2021-096](#))

Chatterjee, M., Le Roux, J., Ahuja, N., Cherian, A., **"Visual Scene Graphs for Audio Source Separation"**, *IEEE International Conference on Computer Vision (ICCV)*, October 2021, pp. 1204-1213. ([TR2021-095](#))

Cherian, A., Pais, G., Jain, S., Marks, T.K., Sullivan, A., **"InSeGAN: A Generative Approach to Segmenting Identical Instances in Depth Images"**, *IEEE International Conference on Computer Vision (ICCV)*, October 2021, pp. 10023-10032. ([TR2021-097](#))

Wang, B., Shin, K.-H., Hidaka, Y., Kondo, S., Arita, H., Ito, K., "**Analytical Magnetic Model for Variable-Flux Interior Permanent Magnet Synchronous Motors**", *IEEE Energy Conversion Congress and Exposition (ECCE)*, DOI: 10.1109/ECCE47101.2021.9595341, October 2021, pp. 4142-4148. ([TR2021-123](#))

Wang, B., Zhou, L., Wang, H., Lin, C., "**Analytical Modeling and Design Optimization of a Vernier Permanent Magnet Motor**", *IEEE Energy Conversion Congress and Exposition (ECCE)*, DOI: 10.1109/ECCE47101.2021.9595230, October 2021, pp. 4480-4485. ([TR2021-124](#))

Rakin, A.S., Wang, Y., Aeron, S., Koike-Akino, T., Moulin, P., Parsons, K., "**Towards Universal Adversarial Examples and Defenses**", *IEEE Information Theory Workshop*, DOI: 10.1109/ITW48936.2021.9611439, ISBN: 978-1-6654-0312-2, October 2021. ([TR2021-125](#))

Chakrabarty, A., Quirynen, R., Romeres, D., Di Cairano, S., "**Learning Disagreement Regions with Deep Neural Networks to Reduce Practical Complexity of Mixed-Integer MPC**", *IEEE International Conference on Systems, Man, and Cybernetics*, DOI: 10.1109/SMC52423.2021.9659186, October 2021, pp. 3238-3244. ([TR2021-126](#))

Wang, Z.-Q., Wichern, G., Le Roux, J., "**Convolutional Prediction for Reverberant Speech Separation**", *IEEE Workshop on Applications of Signal Processing to Audio and Acoustics (WASPAA)*, DOI: 10.1109/WASPAA52581.2021.9632667, October 2021, pp. 56-60. ([TR2021-127](#))

Chakrabarty, A., Bortoff, S.A., Laughman, C.R., "**Simulation Failure Robust Bayesian Optimization for Estimating Black-Box Model Parameters**", *IEEE International Conference on Systems, Man, and Cybernetics (SMC)*, DOI: 10.1109/SMC52423.2021.9658893, October 2021. ([TR2021-128](#))

Wichern, G., Chakrabarty, A., Wang, Z.-Q., Le Roux, J., "**Anomalous sound detection using attentive neural processes**", *IEEE Workshop on Applications of Signal Processing to Audio and Acoustics (WASPAA)*, DOI: 10.1109/WASPAA52581.2021.9632762, October 2021, pp. 186-190. ([TR2021-129](#))

Li, X., Kojima, K., Brand, M.E., "**Predicting Long- and Variable-Distance Coupling Effects in Metasurface Optics**", *IEEE Photonics Conference (IPC)*, DOI: 10.1109/IPC48725.2021.9593086, October 2021, pp. 1-2. ([TR2021-140](#))

Sun, H., Kawano, S., Nikovski, D.N., Takano, T., Mori, K., "**Distribution system fault location analysis using graph neural network with node and link attributes**", *IEEE PES Innovative Smart Grid Technologies Conference - Europe (ISGT Europe)*, DOI: 10.1109/ISGTEurope52324.2021.9639928, October 2021. ([TR2021-130](#))

Menner, M., Di Cairano, S., "**Kernel Regression for Energy-Optimal Control of Fully Electric Vehicles**", *IEEE Vehicle Power and Propulsion Conference*, DOI: 10.1109/VPPC53923.2021.9699361, October 2021, pp. 1-6. ([TR2021-132](#))

Chen, D., Danielson, C., Di Cairano, S., "**A Predictive Controller for Drivability and Comfort in Multi-Motor Electric Vehicles**", *IFAC Modeling, Estimation and Control Conference (MECC)*, DOI: 10.1016/j.ifacol.2021.11.245, October 2021, pp. 650-656. ([TR2021-133](#))

Srinivasan, M., Chakrabarty, A., Quirynen, R., yoshikawa, N., Mariyama, T., Di Cairano, S., **"Fast Multi-Robot Motion Planning via Imitation Learning of Mixed-Integer Programs"**, *IFAC Modeling, Estimation and Control Conference (MECC)*, DOI: 10.1016/j.ifacol.2021.11.237, October 2021, pp. 598-604. ([TR2021-134](#))

Zhang, Z., Liu, D., **"A Graph-based Method to Extract Broken Rotor Bar Fault Signature in Varying Speed Operation"**, *ICEMS 2021*, DOI: 10.23919/ICEMS52562.2021.9634664, ISSN: 2642-5513, ISBN: 978-8-9865-1021-8, October 2021. ([TR2021-135](#))

Demir, A., Koike-Akino, T., Wang, Y., Erdogmus, D., Haruna, M., **"EEG-GNN: Graph Neural Networks for Classification of Electroencephalogram (EEG) Signals"**, *International IEEE EMBS Conference on Neural Engineering*, DOI: 10.1109/EMBC46164.2021.9630194, ISSN: 2694-0604, ISBN: 978-1-7281-1179-7, October 2021. ([TR2021-136](#))

Wang, Z.-Q., Wichern, G., Le Roux, J., **"On The Compensation Between Magnitude and Phase in Speech Separation"**, *IEEE Signal Processing Letters*, DOI: 10.1109/LSP.2021.3116502, Vol. 28, pp. 2018-2022, November 2021. ([TR2021-137](#))

Yao, G., WANG, P., Berntorp, K., Mansour, H., Boufounos, P.T., Orlik, P.V., **"Extended Object Tracking with Spatial Model Adaptation Using Automotive Radar"**, *International Conference on Information Fusion (FUSION)*, ISBN: IEEE Xplore, November 2021, pp. 1-8. ([TR2021-138](#))

Wang, B., Zhou, L., Miyoshi, M., Inoue, H., Kanemaru, M., **"Quantification of Induction Motor Bearing Fault Severity based on Modified Winding Function Theory"**, *International Conference on Electrical Machines and Systems (ICEMS)*, DOI: 10.23919/ICEMS52562.2021.9634328, November 2021, pp. 944-948. ([TR2021-139](#))

Wang, P., Koike-Akino, T., Ma, R., Orlik, P.V., Yamashita, G., Tsujita, W., Nakajima, M., **"Learning-Based THz Multi-Layer Imaging for High-Capacity Positioning"**, *International Conference on Infrared, Millimeter, and Terahertz Waves (IRMMW-THz)*, DOI: 10.1109/IRMMW-THz50926.2021.9566940, ISSN: 2162-2035, ISBN: 978-1-7281-9424-0, November 2021. ([TR2021-098](#))

Furuichi, T., Ma, R., Koike-Akino, T., Komatsuzaki, Y., **"Full-Range Three-Stage 16GSa/s Riemann Pump RF-Power DAC in GaN HEMT"**, *Asia-Pacific Microwave Conference (APMC) 2021*, DOI: 1109/APMC52720.2021.9661641, ISBN: 978-1-6654-3782-0, November 2021. ([TR2021-141](#))

Kojima, K., Tang, Y., Wang, Y., Koike-Akino, T., **"Machine Learning for design and optimization of photonic devices"** in *Machine Learning for Future Fiber Optic Communication Systems* (Elsevier Book), November 2021. ([TR2021-142](#))

Wang, Z.-Q., Wichern, G., Le Roux, J., **"Convolutional Prediction for Monaural Speech Dereverberation and Noisy-Reverberant Speaker Separation"**, *IEEE/ACM Transactions on Audio, Speech, and Language Processing*, DOI: 10.1109/TASLP.2021.3129363, Vol. 29, pp. 3476-3490, December 2021. ([TR2021-144](#))

Yu, X., van Baar, J., Chen, S., Sullivan, A., **"Keypoint-aligned 3D Human Shape Recovery from A Single Imagewith Bilayer-Graph"**, *International Conference on 3D Vision (3DV)*, DOI: 10.1109/3DV53792.2021.00060, December 2021, pp. 505-514. ([TR2021-143](#))

Bonzanini, A.D., Mesbah, A., Di Cairano, S., "**On the Stability Properties of Perception-aware Chance-constrained MPC in Uncertain Environments**", *IEEE Conference on Decision and Control (CDC)*, DOI: 10.1109/CDC45484.2021.9682990, December 2021. ([TR2021-145](#))

Johnson, R.S., Di Cairano, S., Sanfelice, R., "**Parameter Estimation using Hybrid Gradient Descent**", *IEEE Conference on Decision and Control (CDC)*, DOI: 10.1109/CDC45484.2021.9682794, December 2021. ([TR2021-146](#))

Raghunathan, A., "**Homogeneous Formulation of Convex Quadratic Programs for Infeasibility Detection**", *IEEE Conference on Decision and Control (CDC)*, DOI: 10.1109/CDC45484.2021.9682847, ISSN: 2576-2370, ISBN: 978-1-6654-3659-5, December 2021, pp. 968-973. ([TR2021-150](#))

Zhan, S., Wichern, G., Laughman, C.R., Chakrabarty, A., "**Meta-Learned Bayesian Optimization for Building Model Calibration using Attentive Neural Processes**", *Advances in Neural Information Processing Systems (NeurIPS)*, December 2021. ([TR2021-149](#))

Vinod, A.P., Weiss, A., Di Cairano, S., "**Abort-safe spacecraft rendezvous under stochastic actuation and navigation uncertainty**", *IEEE Annual Conference on Decision and Control (CDC)*, DOI: 10.1109/CDC45484.2021.9683322, December 2021, pp. 6620-6625. ([TR2021-148](#))

Quirynen, R., Di Cairano, S., "**Sequential Quadratic Programming Algorithm for Real-Time Mixed-Integer Nonlinear MPC**", *IEEE Conference on Decision and Control (CDC)*, DOI: 10.1109/CDC45484.2021.9683714, December 2021, pp. 993-999. ([TR2021-147](#))

Raghunathan, A., "**Homogeneous Formulation of Convex Quadratic Programs for Infeasibility Detection**", *IEEE Conference on Decision and Control (CDC)*, DOI: 10.1109/CDC45484.2021.9682847, ISSN: 2576-2370, ISBN: 978-1-6654-3659-5, December 2021, pp. 968-973. ([TR2021-150](#))

Berntorp, K., Chakrabarty, A., Di Cairano, S., "**Vehicle Rollover Avoidance by Parameter-Adaptive Reference Governor**", *IEEE Annual Conference on Decision and Control (CDC)*, DOI: 10.1109/CDC45484.2021.9683770, December 2021, pp. 635-640. ([TR2021-151](#))

Teo, K.H., Zhang, Y., Chowdhury, N., Rakheja, S., Ma, R., Xie, Q., Yagyu, E., Yamanaka, K., Li, K., Palacios, T., "**Emerging GaN technologies for power, RF, digital and quantum computing applications: recent advances and prospects**", *Journal of Applied Physics*, DOI: 10.1063/5.0061555, December 2021. ([TR2022-002](#))

Nohra, C.J., Raghunathan, A., Sahinidis, N.V., "**SDP-quality bounds via convex quadratic relaxations for global optimization of mixed-integer quadratic programs**", *Mathematical Programming B*, December 2021. ([TR2022-001](#))

Ma, Y., Guo, J., Wang, Y., Chakrabarty, A., Ahn, H., Orlik, P.V., Guan, X., Lu, C., "**Optimal Dynamic Transmission Scheduling for Wireless Networked Control Systems**", *IEEE Transaction on Control Systems Technology*, DOI: 10.1109/TCST.2022.3141581, January 2022, ([TR2022-043](#))

Jeon, W., Chakrabarty, A., Zemouche, A., Rajamani, R., "**Simultaneous State Estimation and Tire Model Learning for Autonomous Vehicle Applications**", *IEEE/ASME Transactions on Mechatronics*, DOI: 10.1109/TMECH.2021.3081035, Vol. 26, No. 4, pp. 1941-1950, January 2022. ([TR2022-003](#))

Yu, L., Liu, D., Mansour, H., Boufounos, P.T., "**Fast and High-Quality Blind Multi-Spectral Image Pansharpening**", *IEEE Transactions on Geoscience and Remote Sensing*, DOI: 10.1109/TGRS.2021.3091329, ISSN: 1558-0644, Vol. 60, pp. 1-17, January 2022. ([TR2022-004](#))

Fujihashi, T., Koike-Akino, T., Watanabe, T., "**Overhead Reduction for Graph-Based Point Cloud Delivery Using Non-Uniform Quantization**", *IEEE International Conference on Consumer Electronics (ICCE)*, DOI: 10.1109/ICCE53296.2022.9730509, ISSN: 2158-4001, ISBN: 978-1-6654-4154-4, January 2022. ([TR2022-005](#))

Lohit, S., Jones, M.J., "**Model Compression Using Optimal Transport**", *IEEE Winter Conference on Applications of Computer Vision (WACV)*, January 2022. ([TR2022-006](#))

De Silva, U., Ma, R., Koike-Akino, T., Yamashita, A., Nakamizo, H., "**A Modular 1D-CNN Architecture for Real-time Digital Pre-distortion**", *IEEE Radio and Wireless Symposium (RWS) 2022*, ISSN: 2473-4640, ISBN: 978-1-6654-3472-0, January 2022. ([TR2022-007](#))

Zhu, X., Yuan, L., Kim, K.J., Li, Q., Zhang, J., "**Reconfigurable Intelligent Surface-Assisted Spatial Scattering Modulation**", *IEEE Communications Letters*, January 2022. ([TR2022-008](#))

Vijayshankar, S., Chakrabarty, A., Grover, P., Nabi, S., "**Co-Design of Reduced-Order Models and Observers from Thermo-Fluid Data**", *IFAC Journal of Systems and Control*, DOI: 10.1016/j.ifacsc.2021.100181, Vol. 19, pp. 100181, January 2022. ([TR2022-009](#))

Chakrabarty, A., Danielson, C., Bortoff, S.A., Laughman, C.R., "**Accelerating self-optimization control of refrigerant cycles with Bayesian optimization and adaptive moment estimation**", *Applied Thermal Engineering*, February 2022. ([TR2022-010](#))

Medin, S.C., Egger, B., Cherian, A., Wang, Y., Tenenbaum, J.B., Liu, X., Marks, T.K., "**MOST-GAN: 3D Morphable StyleGAN for Disentangled Face Image Manipulation**", *AAAI Conference on Artificial Intelligence*, February 2022. ([TR2022-011](#))

Kantana, C., Ma, R., Benosman, M., Komatsuzaki, Y., Yamanaka, K., "**A Hybrid Heuristic Search Control Assisted Optimization of Dual-Input Doherty Power Amplifier**", *European Microwave Conference 2021*, February 2022. ([TR2022-012](#))

Shah, A., Sra, S., Chellappa, R., Cherian, A., "**Max-Margin Contrastive Learning**", *AAAI Conference on Artificial Intelligence*, February 2022. ([TR2022-013](#))

Cherian, A., Hori, C., Marks, T.K., Le Roux, J., "**(2.5+1)D Spatio-Temporal Scene Graphs for Video Question Answering**", *AAAI Conference on Artificial Intelligence*, February 2022. ([TR2022-014](#))

Ke, L., Peng, K.-C., Lyu, S., "**Towards To-a-T Spatio-Temporal Focus for Skeleton-Based Action Recognition**", *AAAI Conference on Artificial Intelligence*, February 2022. ([TR2022-015](#))



Hori, C., Shah, A.P., Geng, S., Gao, P., Cherian, A., Hori, T., Le Roux, J., Marks, T.K., **"Overview of Audio Visual Scene-Aware Dialog with Reasoning Track for Natural Language Generation in DSTC10"**, *The 10th Dialog System Technology Challenge Workshop at AAI*, February 2022. ([TR2022-016](#))

Shah, A.P., Hori, T., Le Roux, J., Hori, C., **DSTC10-AVSD Submission System with Reasoning using Audio-Visual Transformers with Joint Student-Teacher Learning**, February 2022. ([TR2022-025](#))

Kim, K.J., Yeoh, P.L., Liu, H., Guo, J., Orlik, P.V., Nagai, Y., Poor, H.V., **"A Multi-Cluster-based Distributed CDD Scheme for Asynchronous Joint Transmissions in Local and Private Wireless Networks"**, *IEEE Transactions on Wireless Communications*, February 2022. ([TR2022-027](#))

Cao, W., Benosman, M., Zhang, X., Ma, R., **"Domain Knowledge-Based Automated Analog Circuit Design with Deep Reinforcement Learning"**, *AAAI Conference on Artificial Intelligence*, February 2022. ([TR2022-017](#))

Nabi, S., Grover, P., Caulfield, C.-C., **"Robust preconditioned one-shot methods and direct-adjoint-looping for optimising Reynolds-averaged turbulent flows"**, *Computers & Fluids*, March 2022. ([TR2022-031](#))

Chakrabarty, A., Maddalena, E., Qiao, H., Laughman, C.R., **"Scalable Bayesian Optimization for Parameter Estimation of Coupled Building and HVAC Dynamics"**, *Energy and Buildings*, March 2022. ([TR2022-030](#))

Chakrabarty, A., Maddalena, E., Qiao, H., Laughman, C.R., **"Scalable Bayesian Optimization for Parameter Estimation of Coupled Building and HVAC Dynamics"**, *Energy and Buildings*, March 2022. ([TR2022-030](#))

Bortoff, S.A., Schwerdtner, P., Danielson, C., Di Cairano, S., Burns, D.J., **"H-Infinity Loop-Shaped Model Predictive Control for HVAC Application"**, *IEEE Transactions on Control Systems Technology*, March 2022. ([TR2022-028](#))

Rosen, E., Rammohan, S., Jha, D.K., **"Learning robot motor skills with mixed reality"**, *International Workshop on Virtual, Augmented, and Mixed-Reality for Human-Robot Interactions ACM/IEEE International Conference on Human-Robot Collaboration 2022*, March 2022. ([TR2022-032](#))

Jin, S., Pu, W., Boufounos, P.T., Orlik, P.V., Roy, S., **"Automotive Radar Interference Mitigation with Fast-Time-Frequency Mode Retrieval"**, *IEEE Radar Conference (RadarCon)*, March 2022. ([TR2022-029](#))

Anantharaman, R., Abdelrahim, A., Martinuzzi, F., Yalburgi, S., Saba, E., Fischer, K., Hertz, G., de Vos, P., Laughman, C.R., Ma, Y., Shah, V., Edelman, A., Rackauckas, C., **"Composable and Reusable Neural Surrogates to Predict System Response of Causal Model Components"**, *AAAI 2022 Workshop on AI based Design and Manufacturing*, March 2022. ([TR2022-034](#))



## Research

The body and soul of any research lab is its portfolio of research projects. The main body of this annual report consists of descriptions of research recently done at MERL. The reports are grouped into the seven areas MERL's research is focused on.

**Media Intelligence** – Enabling machines to perceive, understand, navigate, and interact with the world, by extracting meaning and building representations of scenes, objects, and events. Developing machine learning algorithms to perform a wide range of inference tasks including detection, classification, recognition, and reconstruction, and applying these algorithms to problems in computer vision, speech, and audio processing.

**Robotics** – Algorithms for enabling a new generation of industrial and household robots to plan optimally their motion in response to rich sensor information in challenging robotic automation applications that involve contact-rich manipulation. Methods for human-robot interaction that allow safe close collaboration with human workers on work tasks, as well as learning from instruction given by such human operators. Machine learning algorithms for system identification of robot dynamics and learning of control policies from human demonstration or self-experimentation.

**Optimization & Data Analytics** – Highly scalable continuous and discrete optimization and scheduling algorithms that can be applied to electrical power systems, various transportation systems (trains, elevators, cars), heating, ventilation, and air conditioning (HVAC) systems and solutions, and factory automation. The application of these algorithms minimizes costs, increases reliability, improves energy efficiency, and reduces environmental impact of products. Algorithms for analysis of industrial big data, including multidimensional time series of process measurements, for the purpose of anomaly detection, diagnostics, prognostics, and condition-based maintenance of equipment.

**Connectivity & Information Processing** – Research on communications networks performance and security, and information processing developing fundamental machine learning methods for robust inference, distributed learning, bio-signal processing, and quantum machine learning.

**Computational Sensing** – Exploring novel architectures for signal acquisition and sensing, methods to acquire and filter signals in the presence of noise and other degrading factors, techniques that fuse signals from multiple sensing modalities, and approaches to infer meaning from processed signals. Research focused on signal acquisition, modeling, and reconstruction algorithms, with applications to autonomous vehicles, factory automation, navigation systems, automotive radars, public security, non-contact sensing and radar imaging, among others.

**Control for Autonomy** – Developing novel control, motion planning and estimation algorithms with improved performance and robustness, and reduced computational footprint aimed at increasing the capabilities of autonomous mobile systems. Special focus areas include model predictive control, statistical estimation, constrained control, motion planning, stochastic control, integration of learning and control, and real-time optimization for control. The main application areas are driver assistance and automated driving systems, space systems, global positioning systems, team of drones, and electric vehicles.

**Electric Machines & Devices** – Research on multi-physical modeling & simulations as a basis for producing model-based design for motors, RF circuits and devices; develop optimal control and estimation algorithms for motor drive, motion control to achieve improved performance and reliability; apply signal processing and other fundamentals for predictive maintenance of electric machines; and utilize AI technologies to speed up design process, enable data-driven/learning-based control and intelligent performance monitoring.

**Multi-Physical Systems** – Research on multi-physical modeling & simulation as a basis for producing model-based designs for devices, systems, and controls to achieve optimized performance with high efficiency; developing computational methods that connect physics-based models, controls, estimation, and machine learning to enable digital twin solutions. Target applications include HVAC systems, factory automation, robotics, energy-efficient buildings, and energy systems.

## Media Intelligence

Media Intelligence research at MERL encompasses machine learning applied to media signals for a particular inference task. The media signals primarily include audio, visual and textual data, but may also include thermal and infrared imagery, 3D point cloud and range data, as well as other modalities. Comprehensive scene understanding is a key aspect of Media Intelligence with example inference tasks including object detection and classification, sound analysis and separation, multimodal analysis, and natural language processing. Key research themes include robust machine learning for improved scene understanding, data-efficient learning using semi-/un-supervised techniques, effective utilization of multiple data modalities, as well as cognition and reasoning based on learned semantic representations. We apply our work to a broad range of applications involving monitoring, interaction, and navigation.

### Recent research

TURNIP: Time-series U-NET with Recurrence for NIR Imaging PPG.....	42
A 3D Morphable StyleGAN for Disentangled Face Image Manipulation .....	42
Spatio-Temporal Focus for Skeleton-Based Action Recognition .....	43
Model Compression Using Optimal Transport.....	43
Visual Scene Graphs for Audio Source Separation .....	44
D Spatio-Temporal Scene Graphs for Video Question Answering.....	44
Optimizing Video Captioning Latency Using Audio-Visual Transformers .....	45
Anomalous sound detection using attentive neural processes.....	45
Speech Dereverberation and Noisy-Reverberant Speaker Separation .....	46
Speech Recognition via Graph-Based Temporal Classification.....	46

## TURNIP: Time-series U-NET with Recurrence for NIR Imaging PPG

Citation: Comas, A., Marks, T.K., Mansour, H., Lohit, S., Ma, Y., Liu, X., "TURNIP: Time-series U-NET with Recurrence for NIR Imaging PPG", IEEE International Conference on Image Processing (ICIP), September 2021.

Contacts: Tim Marks, Hassan Mansour, Suhas Lohit

Imaging photo-plethysmography (iPPG) is the process of estimating the waveform of a person's pulse by processing a video of their face to detect minute color or intensity changes in the skin. To deal with

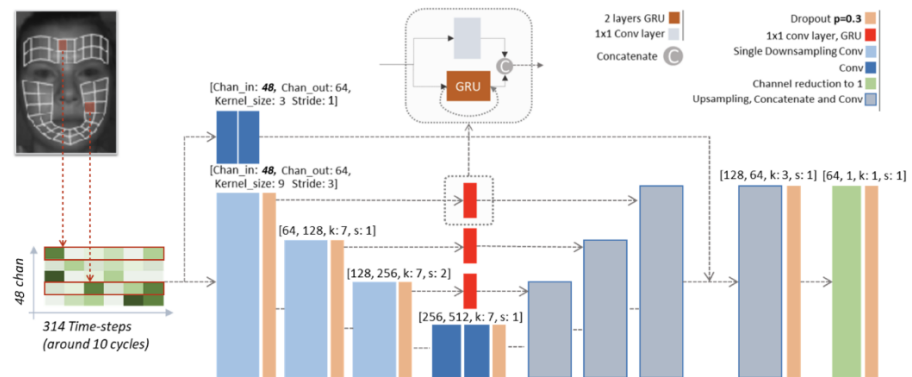

rapidly changing and insufficient lighting in situations such a driving, we use active illumination and bandpass filtering from a monochromatic near-infrared (NIR) light source and camera. We propose a novel time-series U-net architecture in which a Gated Recurrent Unit (GRU) network is added to the passthrough layers. Our model's iPPG estimation performance on NIR video outperforms both the state-of-the-art model-based method and a recent end-to-end deep learning method that we adapted to monochromatic video.

## A 3D Morphable StyleGAN for Disentangled Face Image Manipulation

Citation: Medin, S.C., Egger, B., Cherian, A., Wang, Y., Tenenbaum, J.B., Liu, X., Marks, T.K., "MOST-GAN: 3D Morphable StyleGAN for Disentangled Face Image Manipulation", AAAI Conference on Artificial Intelligence, February 2022.

Contacts: Anoop Cherian, Ye Wang, Tim K. Marks

While methods that use style-based generative adversarial networks (GANs) can generate strikingly photorealistic face

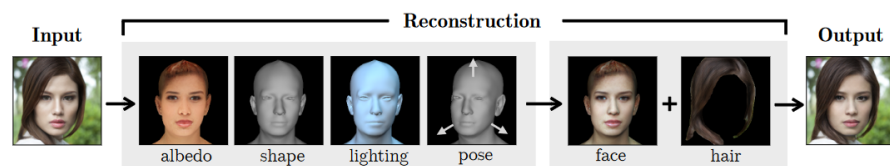

images, it is often difficult to control the characteristics of the generated faces in a meaningful and disentangled way. We propose a framework that a priori models physical attributes of the face such as 3D shape, albedo, pose, and lighting explicitly, thus providing disentanglement by design. Our method, MOST-GAN achieves photorealistic manipulation of portrait images with fully disentangled 3D control over their physical attributes, enabling extreme manipulation of lighting, facial expression, and pose variations up to full profile view.

## Spatio-Temporal Focus for Skeleton-Based Action Recognition

Citation: Ke, L., Peng, K.-C., Lyu, S., "Towards To-a-T Spatio-Temporal Focus for Skeleton-Based Action Recognition", AAAI Conference on Artificial Intelligence, February 2022.

Contacts: Kuan-Chuan Peng

Graph Convolutional Networks (GCNs) have been widely used to model the high-order dynamic dependencies for skeleton-based action recognition. We propose the To-a-T Spatio-Temporal Focus (STF) skeleton-based action recognition framework that embeds the high-order spatio-temporal importance of joints' spatial connection topology and utilizes spatio-temporal gradients to focus on relevant spatio-temporal features. We use STF modules with learnable gradient-enforced and instance-dependent adjacency matrices to model the high-order spatio-temporal dynamics. Second, we use three loss terms defined on the gradient-based spatio-temporal focus to explicitly guide the classifier when and where to look at, distinguish confusing classes, and optimize the stacked STF modules. To-a-T outperforms the state-of-the-art methods on the NTU RGB+D 60, NTU RGB+D 120, and Kinetics Skeleton 400 datasets in all 15 settings over different views, subjects, setups, and input modalities.

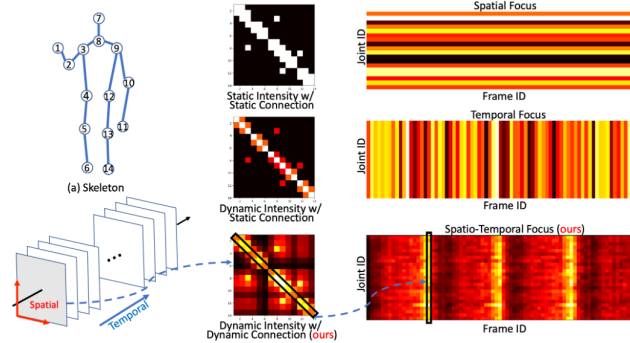

## Model Compression Using Optimal Transport

Citation: Lohit, S., Jones, M.J., "Model Compression Using Optimal Transport", IEEE Winter Conference on Applications of Computer Vision (WACV), January 2022.

Contacts: Suhas Lohit, Michael Jones

Model compression methods are important to allow for easier deployment of deep learning models in compute, memory and energy-constrained environments such as mobile phones. Knowledge distillation is a class of model compression algorithm where knowledge from a large teacher network is transferred to a smaller student network thereby improving the student's performance. We show how optimal transport-based loss functions can be used for training a student network which encourages learning student network parameters that help bring the distribution of student features closer to that of the teacher features. We present image classification results on CIFAR-100, SVHN and ImageNet and show that the proposed optimal transport loss function performs comparably to or better than other loss functions.

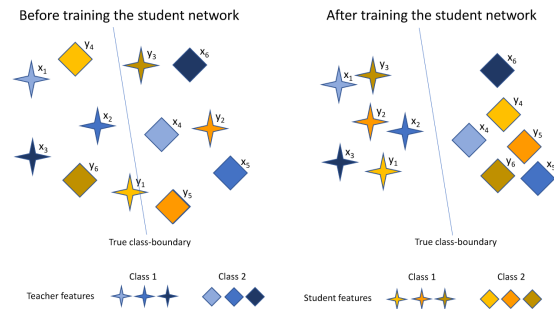

## Visual Scene Graphs for Audio Source Separation

Citation: Chatterjee, M., Le Roux, J., Ahuja, N., Cherian, A., "Visual Scene Graphs for Audio Source Separation", IEEE International Conference on Computer Vision (ICCV), October 2021, pp. 1204-1213.

Contacts: Jonathan Le Roux, Anoop Cherian

Our Audio Visual Scene Graph Segmenter (AVSGS), is a novel deep learning model that embeds the visual structure of the scene as a graph and segments this graph into subgraphs, each subgraph being associated with a unique sound obtained via co-segmenting

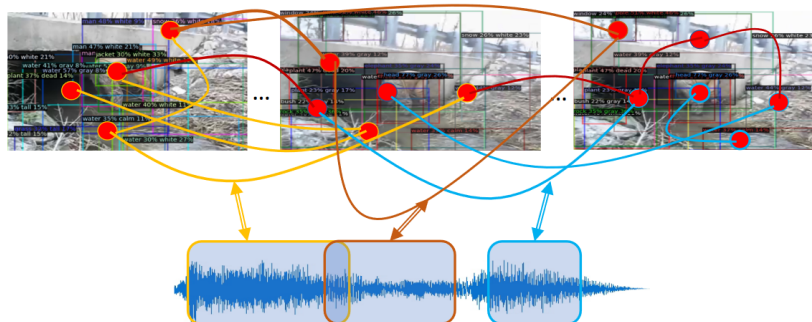

the audio spectrogram. At its core, AVSGS uses a recursive neural network that emits mutually-orthogonal sub-graph embeddings of the visual graph using multi-head attention, these embeddings conditioning an audio encoder-decoder towards source separation. Thorough experiments on the proposed ASIW and the standard MUSIC datasets demonstrate state-of-the-art sound separation performances of our method against recent prior approaches.

## D Spatio-Temporal Scene Graphs for Video Question Answering

Citation: Cherian, A., Hori, C., Marks, T.K., Le Roux, J., "(2.5+1)D Spatio-Temporal Scene Graphs for Video Question Answering", AAAI Conference on Artificial Intelligence, February 2022.

Contacts: Anoop Cherian, Chiori Hori, Tim K. Marks, Jonathan Le Roux

Spatio-temporal scene-graph approaches to video-based reasoning tasks such as video question-answering (QA) often ignore the fact that videos are essentially sequences of 2D “views” of

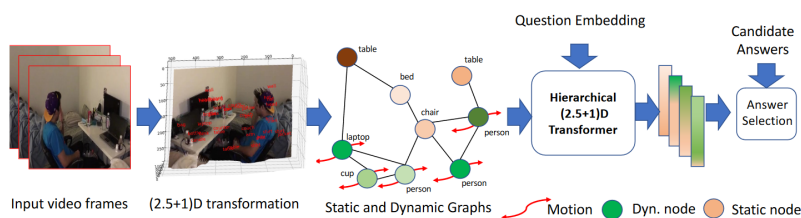

events happening in a 3D space, and that the semantics of the 3D scene can thus be carried over from frame to frame. We propose a (2.5+1)D scene graph representation to better capture spatio-temporal information flows in videos. Specifically, we first create a 2.5D (pseudo-3D) scene graph by transforming every 2D frame to have an inferred 3D structure, following which we register the video frames into a shared (2.5+1)D spatio-temporal space. Next, for the video QA task, we present a novel transformer-based reasoning pipeline that embeds the (2.5+1)D graph into a spatio-temporal hierarchical latent space, where the sub-graphs and their interactions are captured at varied granularity. Our results show that our hierarchical model showcases superior performance on the video QA task versus the state of the art.



## Optimizing Video Captioning Latency Using Audio-Visual Transformers

Citation: Hori, C., Hori, T., Le Roux, J., "Optimizing Latency for Online Video Captioning Using Audio-Visual Transformers", Annual Conference of the International Speech Communication Association (Interspeech), DOI: 10.21437/Interspeech.2021-1975, August 2021, pp. 586–590.  
 Contacts: Chiori Hori, Jonathan Le Roux

We propose a novel approach to optimize the output timing of video captions based on a trade-off between latency and caption quality. An audio-visual Transformer is trained to generate groundtruth captions using only a small number of frames without seeing all video frames while mimicing the output of a pre-trained Transformer to which all the frames are given. A CNN-based timing detector is also trained to detect a timing, where the captions generated by the two Transformers become sufficiently close to each other. With the jointly trained Transformer and timing detector, a caption can be generated in an early stage of a video clip as soon as an event happens or when it can be forecasted. Experiments with the ActivityNet Captions dataset show that our approach achieves 90% of the caption quality using only 20% of the video frames.

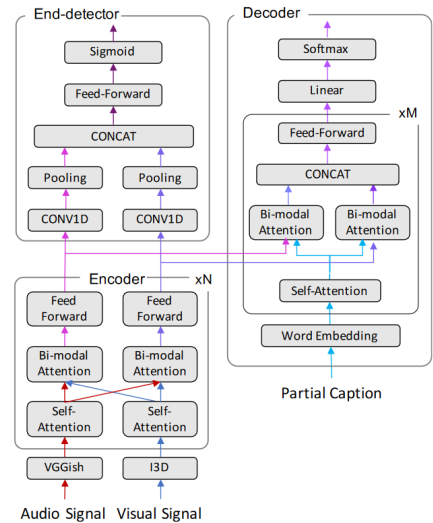

## Anomalous sound detection using attentive neural processes

Citation: Wichern, G., Chakrabarty, A., Wang, Z.-Q., Le Roux, J., "Anomalous sound detection using attentive neural processes", IEEE Workshop on Applications of Signal Processing to Audio and Acoustics (WASPAA), DOI: 10.1109/WASPAA52581.2021.9632762, October 2021, pp. 186-190.  
 Contacts: Gordon Wichern, Ankush Chakrabarty, Jonathan Le Roux

A typical approach for unsupervised anomaly detection of machine sounds learns an autoencoder model for reconstructing the spectrograms of normal sounds. During inference, fidelity of the reconstruction can be used to identify anomalous sounds different from normal sounds encountered during training. Recent improvements to the baseline autoencoder approach mask certain regions of the spectrogram at the input to the autoencoder, and then use the reconstruction error over masked regions as the anomaly score. We propose an alternative approach based on the attentive neural process, a recently proposed meta-learning technique for estimating distributions over signals. A benefit of our approach is that masked regions of the spectrogram do not need to be pre-specified at training time, and can be determined based on signal properties or prior knowledge.

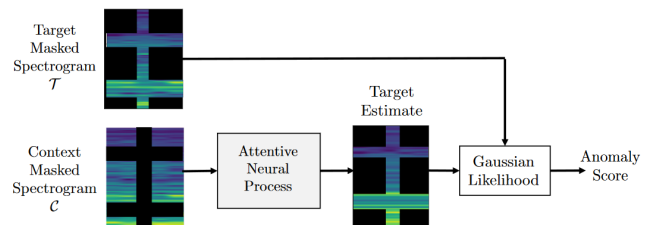

## Speech Dereverberation and Noisy-Reverberant Speaker Separation

Citation: Wang, Z.-Q., Wichern, G., Le Roux, J., "Convolutional Prediction for Monaural Speech Dereverberation and Noisy-Reverberant Speaker Separation", IEEE/ACM Transactions on Audio, Speech, and Language Processing, DOI: 10.1109/TASLP.2021.3129363, Vol. 29, pp. 3476-3490, December 2021.

Contacts: Gordon Wichern, Jonathan Le Roux

We propose to exploit the linear-filter structure of reverberation within a supervised deep learning based monaural speech dereverberation framework. The key idea is to first estimate the direct-path signal of the target speaker using a DNN and then identify signals that are decayed and delayed copies of the estimated direct-path signal, as these can be reliably considered as reverberation. We then modify the proposed algorithm for speaker separation in reverberant and noisy-reverberant conditions. State-of-the-art speech dereverberation and speaker separation results are obtained.

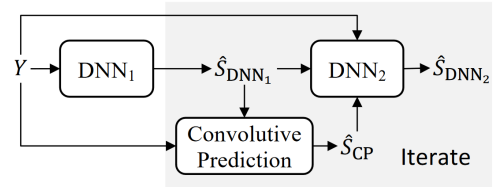

## Speech Recognition via Graph-Based Temporal Classification

Citation: Moritz, N., Hori, T., Le Roux, J., "Semi-Supervised Speech Recognition via Graph-Based Temporal Classification", IEEE International Conference on Acoustics, Speech, and Signal Processing (ICASSP), DOI: 10.1109/ICASSP39728.2021.9414058, June 2021, pp. 6548-6552.

Contacts: Jonathan Le Roux

Semi-supervised learning has demonstrated promising results in automatic speech recognition (ASR) by self-training using a seed ASR model with pseudo-labels generated for unlabeled data. The effectiveness of this approach largely relies on the pseudo-label accuracy, for which typically only the 1-best ASR hypothesis is used. However, alternative ASR hypotheses of an N-best list can provide more accurate labels for an unlabeled speech utterance and also reflect uncertainties of the seed ASR model. We propose a generalized form of the connectionist temporal classification (CTC) objective that accepts a graph representation of the training labels. The newly proposed graph-based temporal classification (GTC) objective is applied for self-training with WFST-based supervision, which is generated from an N-best list of pseudo-labels. In this setup, GTC is used to learn not only a temporal alignment, similarly to CTC, but also a label alignment to obtain the optimal pseudo-label sequence from the weighted graph. Results show that this approach can effectively exploit an N-best list of pseudo-labels with associated scores, considerably outperforming standard pseudo-labeling.

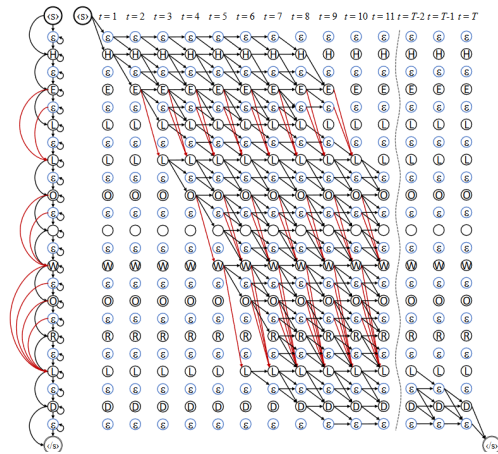

## Robotics

Recently, modern robotics technology has been developing very rapidly, propelled by advances in artificial intelligence, hardware, and distributed software. We have been pursuing a research agenda aiming to create highly automated and easy-to-program sensor-rich robots that can reduce drastically the deployment time and cost of MELCO robots used for industrial applications. Critical enabling AI technologies are machine learning that allows robots to acquire control policies autonomously by self-experimentation or from human demonstrations, as well as computer vision that enables robots to use new sensors for better scene understanding. Planning and scheduling algorithms based on advanced optimization also reduce or eliminate the need to program robots explicitly. The advent of collaborative robots will likely lead to expansion of robotics into new markets of much larger size, including new industries and even regular households. These more advanced collaborative robots will require advanced modes of interactivity and learning through audio-visual input. We also aim to make contributions to fundamental areas of robotics, such as the mechanics of manipulation and contact physics, and use their computational implementations as parts of advanced physics engines for fast simulation and acquisition of plans and control policies.

## Recent research

Tactile-RL for Insertion: Generalization to Objects of Unknown Geometry .....	48
Trajectory Optimization for Manipulation of Deformable Objects .....	48
Control of Mechanical Systems via Black-Box Gaussian Process Models.....	49
Robotic Applications of Cthulhu-Morphic Grippers .....	49
Visual 3D Perception for Interactive Robotic Tactile Data Acquisition .....	50
Reinforcement Learning Using Monte Carlo Gradient Estimation.....	50
A Visual Inertial Odometry Framework for 3D Points, Lines and Planes.....	51
Robot Motion Planning via Imitation Learning of Mixed-Integer Programs .....	51

## Tactile-RL for Insertion: Generalization to Objects of Unknown Geometry

Citation: Dong, S., Jha, D.K., Romeres, D., Kim, S., Nikovski, D.N., Rodriguez, A., "Tactile-RL for Insertion: Generalization to Objects of Unknown Geometry", IEEE International Conference on Robotics and Automation (ICRA), May 2021.

Contacts: Devesh K. Jha, Diego Romeres, Daniel N. Nikovski

Object insertion is a classic contact-rich manipulation task. The task remains challenging, especially when considering general objects of unknown geometry, which significantly limits the ability to understand the contact configuration between the object and the environment. We study the problem of aligning the object and environment with a tactile-based feedback insertion policy. The insertion process is modeled as an episodic policy that iterates between insertion attempts

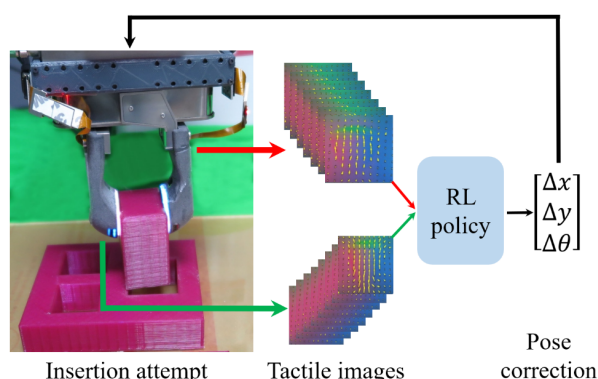

followed by pose corrections. The key contribution of this paper is to demonstrate that it is possible to learn a tactile insertion policy that generalizes across different object geometries.

## Trajectory Optimization for Manipulation of Deformable Objects

Citation: Jin, S., Romeres, D., Raghunathan, A., Jha, D.K., Tomizuka, M., "Trajectory Optimization for Manipulation of Deformable Objects: Assembly of Belt Drive Units", IEEE International Conference on Robotics and Automation (ICRA), DOI: 10.1109/ICRA48506.2021.9561556, ISSN: 2577-087X, ISBN: 978-1-7281-9077-8, June 2021.

Contacts: Diego Romeres, Arvind Raghunathan, Devesh K. Jha

This paper presents a novel trajectory optimization formulation to solve the robotic assembly of the belt drive unit task. Robotic manipulations involving contacts and deformable objects are challenging in both dynamic modeling and trajectory planning. For modeling, variations in the belt tension and contact forces between the belt and the pulley can dramatically change the system dynamics. For trajectory planning, it is computationally expensive to plan trajectories for such hybrid dynamical systems as it usually requires planning for discrete modes separately.

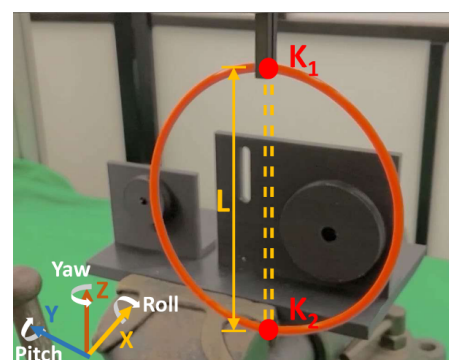

We formulate the belt drive unit assembly task as a trajectory optimization problem with complementarity constraints to avoid explicitly imposing contact mode sequences. The problem is solved as a mathematical program with complementarity constraints (MPCC) to obtain feasible and efficient assembly trajectories.

## Control of Mechanical Systems via Black-Box Gaussian Process Models

Citation: Dalla Libera, A., Amadio, F., Nikovski, D.N., Carli, R., Romeres, D., "Control of Mechanical Systems via Feedback Linearization Based on Black-Box Gaussian Process Models", European Control Conference (ECC), DOI: 10.23919/ECC54610.2021.9654429, ISBN: 978-9-4638-4236-5, June 2021.

Contacts: Daniel N. Nikovski, Diego Romeres

In this paper, we consider the use of black-box Gaussian process (GP) models for trajectory tracking control based on feedback linearization, in the context of mechanical systems. We considered two strategies. The first computes the control input directly by using the GP model, whereas the second computes the input after estimating the individual components of the dynamics. We tested the two strategies on a simulated manipulator with seven degrees of freedom, also varying the GP kernel choice. Results show that the second implementation is more robust w.r.t. the kernel choice and model inaccuracies. Moreover, as regards the choice of kernel, the obtained performance shows that the use of a structured kernel, such as a polynomial kernel, is advantageous, because of its effectiveness with both strategies.

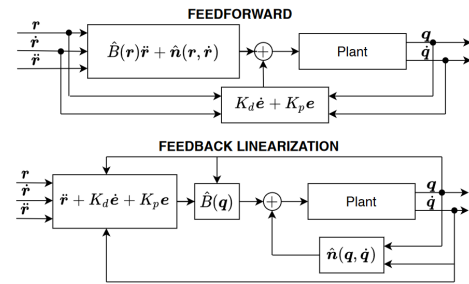

## Robotic Applications of Cthulhu-Morphic Grippers

Citation: Solomon, E., Yerazunis, W.S., "Robotic Applications of Mechanical Metamaterials Produced Using SLA 3D Printing: Cthulhu-Morphic Grippers", Solid Freeform Fabrication Symposium, August 2021.

Contacts: William S. Yerazunis

A multi-tentacular 3D-printed soft robotic gripper with 12 independently actuated degrees of freedom (DoF) is developed and tested. The gripper achieves both broad flexibility of each tentacle and high overall strength of the gripper by creating each tentacle from a mechanical metamaterial, produced using SLA 3D printing. This additive manufacturing method was paramount to the success of this design because key features of the chosen architecture could not have been easily manufactured any other way. With the exception of the steel-cable tendons, 100% of the actual tentacles are 3D printed. The gripper uses RC servos and tension cables to provide +/- 120 degree of flex range per tentacle section, with centralized control. The gripper is quantitatively evaluated for grip strength for multiple objects, grip modes and pull directions. With an axial lift strength well in excess of 100 N (lifting > 10 kg) the gripper is strong enough to be useful in industrial applications.



## Visual 3D Perception for Interactive Robotic Tactile Data Acquisition

Citation: Jain, S., Corcodel, R., van Baar, J., "Visual 3D Perception for Interactive Robotic Tactile Data Acquisition", IEEE International Conference on Automation Science and Engineering (CASE 2021), August 2021.

Contacts: Siddarth Jain, Radu Corcodel

We present a novel approach for tactile saliency computation on 3D point clouds of unseen object instances, where we define salient points as those that provide informative tactile sensory information with robotic interaction. Our intuition is that the local 3D surface geometries of objects contain characteristic information both in terms of texture and shape which can provide important discriminating information for tactile interactions. We solve the problem by taking as input a 3D point cloud of an object and develop a

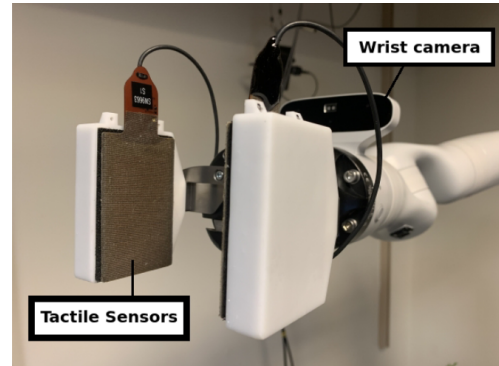

geometric approach which computes the tactile saliency map for the object without requiring pre-training. We furthermore develop a formulation to compute grasps using the tactile saliency for prehensile probing manipulation. We demonstrate our framework with evaluation on a variety of household objects in real-world experiments. Since it is difficult to manually define a ground truth tactile saliency measure, we evaluate our approach by having a human subject provide saliency information as baseline in pilot experiments.

## Reinforcement Learning Using Monte Carlo Gradient Estimation

Citation: Amadio, F., Dalla Libera, A., Carli, R., Romeres, D., "Model-Based Reinforcement Learning Using Monte Carlo Gradient Estimation", Automatica.it, September 2021.

Contacts: Diego Romeres

We propose an MBRL algorithm named Monte Carlo Probabilistic Inference for Learning Control (MC-PILCO). MC-PILCO is a policy gradient algorithm, which uses GPs to model the system dynamics, but it overcomes PILCO's limitations by relying on a particle-based method to compute long-term predictions, instead of using moment matching.

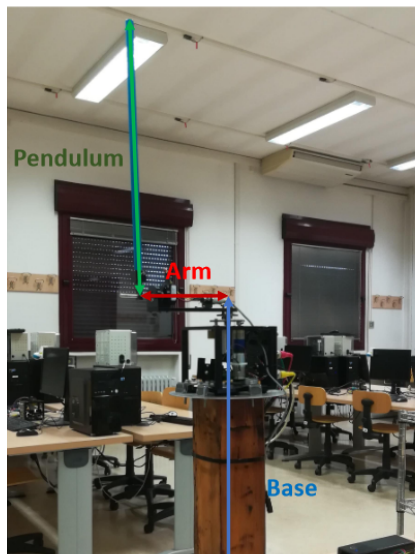

## A Visual Inertial Odometry Framework for 3D Points, Lines and Planes

Citation: Kannapiran, S., van Baar, J., Berman, S., "A Visual Inertial Odometry Framework for 3D Points, Lines and Planes", IEEE/RSJ International Conference on Intelligent Robots and Systems (IROS), DOI: 10.1109/IROS51168.2021.9636526, September 2021.

Contacts: Diego Romeres

We present a Visual Inertial Odometry (VIO) framework which uses 3D points, lines and planes from RGB-D data to address the challenge of rigid registration between successive camera poses in feature-poor environments. Previous VIO approaches have incorporated 2D features, but robust correspondences cannot be determined in low-texture and low-light situations. We show that by directly exploiting 3D geometric primitives we can achieve improved registration. We demonstrate our approach on different environments and compare the addition of different 3D geometric primitives to a ground truth trajectory obtained by a motion capture system. We consider computationally efficient methods for detecting 3D points, lines and planes, since our goal is to implement our approach on mobile robots, such as drones.

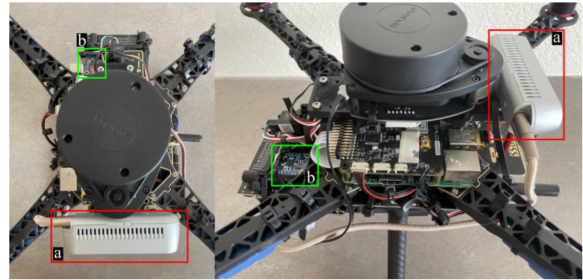

## Robot Motion Planning via Imitation Learning of Mixed-Integer Programs

Citation: Srinivasan, M., Chakrabarty, A., Quirynen, R., Yoshikawa, N., Mariyama, T., Di Cairano, S., "Fast Multi-Robot Motion Planning via Imitation Learning of Mixed-Integer Programs", IFAC Modeling, Estimation and Control Conference (MECC), DOI: 10.1016/j.ifacol.2021.11.237, October 2021, pp. 598-604.

Contacts: Ankush Chakrabarty, Rien Quirynen, Stefano Di Cairano

We propose a centralized multi-robot motion planning approach that leverages machine learning and mixed-integer programming (MIP). We train a neural network to imitate optimal MIP solutions and, during execution, the trajectories predicted by the network are used to fix most of the integer variables, resulting in a significantly reduced MIP or even a convex program. If the obtained trajectories are feasible, i.e., collision-free and reaching the goal, they can be used as-is or further refined towards optimality. Since maximizing the likelihood of feasibility is not the standard goal of imitation learning, we propose several techniques aimed at increasing such likelihood. Simulation results show the reduced computational burden associated with the proposed framework and the similarity with optimal MIP solutions

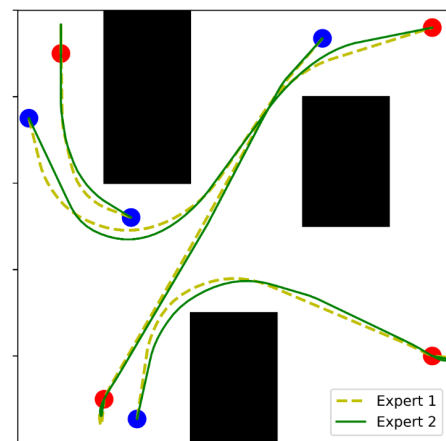





# Optimization & Data Analytics

Decision optimization research emphasizes numerical methods for fast solution of continuous and discrete optimization problems that can be scaled up to problems of industrial size and complexity. Optimization methods find application in many application domains, including the analysis of electrical power systems and Smart Grids comprising renewable power sources with intermittent output as well as highly variable loads such as electrical vehicles. Furthermore, many problems in transportation systems, such as train operation optimization, group elevator scheduling, car navigation and fully autonomous driving, as well as energy optimization in buildings, can be solved by planning and optimization algorithms. Similarly, a number of problems in robotics, factory automation, and production planning and scheduling can be addressed successfully by means of decision-theoretic planning, sequential optimization, and reinforcement learning methods. Fast and reliable optimization algorithms are also the foundation of optimizing control of dynamical systems. Conversely, and somewhat unusually, we have borrowed some ideas from the field of dynamical systems to design superior optimization algorithms. We have also started to explore the application of quantum computing to optimization problems that, due to their structure, might end up being some of the first where this exciting new computational technology will achieve practical use.

## Recent research

- Extremum Seeking-Based Observer Design of Thermal-Fluid Systems ..... 54
- Adaptive Dynamic Mode Decomposition for Reduce Order Modelling of PDEs ..... 54
- Dynamic Thermal Comfort Optimization for Groups..... 55
- Safe Learning-based Observers for Unknown Nonlinear Systems..... 55
- Airflow Optimization for Room Air Conditioners ..... 56
- Distribution System Fault Location Analysis Using Graph Neural Network..... 56
- SDP-Quality Bounds for Optimization of Mixed-Integer Quadratic Programs..... 57
- Formulation of Convex Quadratic Programs for Infeasibility Detection ..... 57
- Automated Analog Circuit Design with Deep Reinforcement Learning ..... 58

## Extremum Seeking-Based Observer Design of Thermal-Fluid Systems

Citation: Koga, S., Benosman, M., Borggaard, J., "Extremum Seeking-Based Observer Design for Reduced Order Models of Coupled Thermal and Fluid Systems", International Journal of Adaptive Control and Signal Processing, April 2021.

Contacts: Mouhacine Benosman  
 We present an extremum seeking-based robust observer design for thermal-fluid systems, pursuing an application to efficient energy management in buildings. The model is originally described by Boussinesq equations which is given by a system of two coupled partial differential equations (PDEs) for the velocity field and temperature profile constrained to incompressible flow. Using proper orthogonal decomposition (POD), the PDEs are reduced to a set of nonlinear ordinary differential equations (ODEs). Given a set of temperature and velocity point measurements, a nonlinear state observer is designed to reconstruct the entire state under the error of initial states, and model parametric uncertainties. We prove that the closed loop system for the observer error state satisfies an estimate of L2 norm in a sense of locally input-to-state stability (LISS) with respect to parameter uncertainties. Moreover, the uncertain parameters estimate used in the designed observer are optimized through iterations of a data-driven extremum seeking (ES) algorithm. Numerical simulation of a 2D Boussinesq PDE illustrates the performance of the proposed adaptive estimation method.

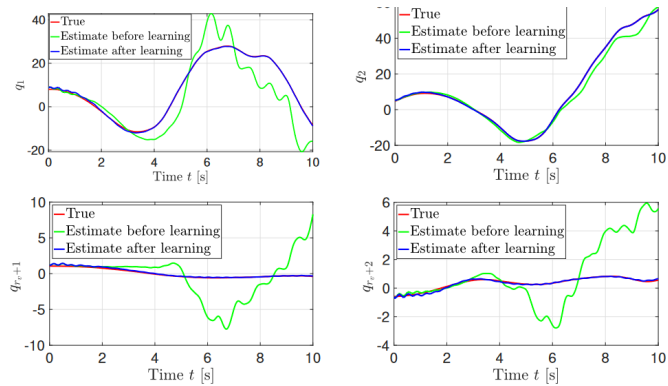

## Adaptive Dynamic Mode Decomposition for Reduce Order Modelling of PDEs

Citation: Kalur, A., Nabi, S., Benosman, M., "Robust Adaptive Dynamic Mode Decomposition for Reduce Order Modelling of Partial Differential Equations", American Control Conference (ACC), May 2021.

Contacts: Saleh Nabi, Mouhacine Benosman

This work focuses on the design of stable reduced-order models (ROMs) for partial differential equations (PDEs) with parametric uncertainties. More specifically, we focus here on using dynamic mode decomposition (DMD) to reduce a PDE to a DMD-ROM and then pose the ROM stabilization or closure problem in the framework of nonlinear robust control. Using this robust control framework, we design two DMD-ROM closure models that are robust to parametric uncertainties and truncation of modes. We finally add an adaptation layer to our framework, where we tune the closure models in real-time, using data-driven extremum seeking controllers.

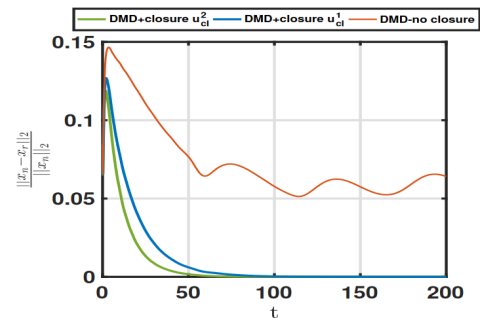

## Dynamic Thermal Comfort Optimization for Groups

Citation: Laftchiev, E., Romeres, D., Nikovski, D.N., "Dynamic Thermal Comfort Optimization for Groups", American Control Conference (ACC), May 2021.  
 Contacts: Diego Romeres, Daniel N. Nikovski

Automatic optimization of individual thermal comfort in indoor spaces shared by multiple occupants is difficult, because it requires understanding of the individual thermal comfort preferences, modeling of the room thermodynamics, and fast online optimization to account for movements of the occupants. We explore an approach to optimizing individual thermal comfort subject to the seating arrangement of a group of individuals through temperature set-point optimization of Heating, Ventilation, and Air Conditioning (HVAC) equipment. We learn both the individual thermal comfort preferences using a weakly supervised approach and the room thermodynamics via static approximations. Finally, we use optimization to determine the HVAC set points that maximize individual thermal comfort subject to the current seating arrangement.

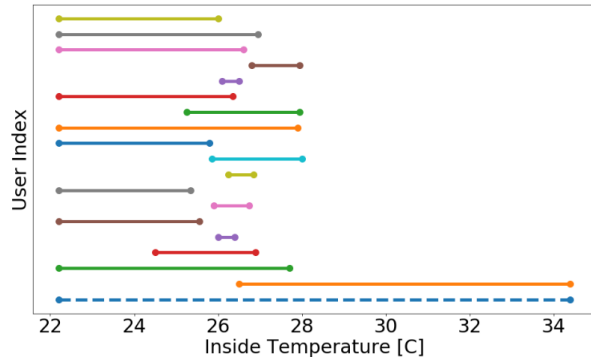

## Safe Learning-based Observers for Unknown Nonlinear Systems

Citation: Chakrabarty, A., Benosman, M., "Safe Learning-based Observers for Unknown Nonlinear Systems using Bayesian Optimization", Automatica, DOI: 10.1016/j.automatica.2021.109860, August 2021.  
 Contacts: Ankush Chakrabarty, Mouhacine Benosman

Data generated from dynamical systems with unknown dynamics enable the learning of state observers that are: robust to modeling error, computationally tractable to design, and capable of operating with guaranteed performance. In this paper, a modular design methodology is formulated, that consists of three design phases: (i) an initial robust observer design that enables one to learn the dynamics without allowing the state estimation error to diverge (hence, safe); (ii) a learning phase wherein the unmodeled components are estimated using Bayesian optimization and Gaussian processes; and, (iii) a re-design phase that leverages the learned dynamics to improve convergence rate of the state estimation error. The potential of our proposed learning-based observer is demonstrated on a benchmark nonlinear system. Additionally, certificates of guaranteed estimation performance are provided.

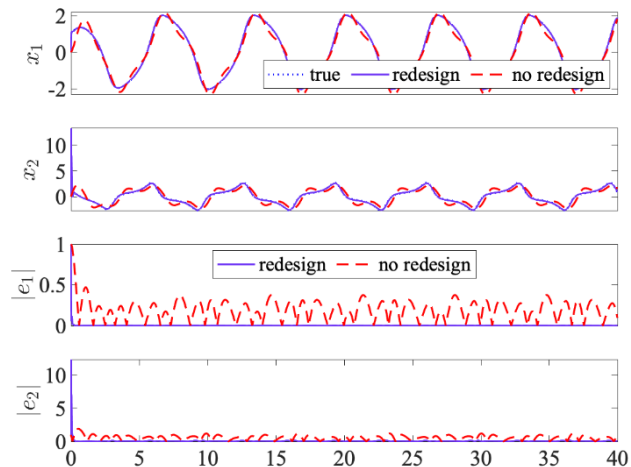

## Airflow Optimization for Room Air Conditioners

Citation: Tanaka, R., Nabi, S., Nonaka, M., "Airflow Optimization for Room Air Conditioners", Building Simulation 2021 Conference, September 2021.  
Contacts: Saleh Nabi

The purpose of this paper is to increase the energy efficiency of room air conditioners (RAC) while achieving a comfortable indoor space. We pose the problem as a multi-objective optimization problem in which the design variables are the inlet temperature, air

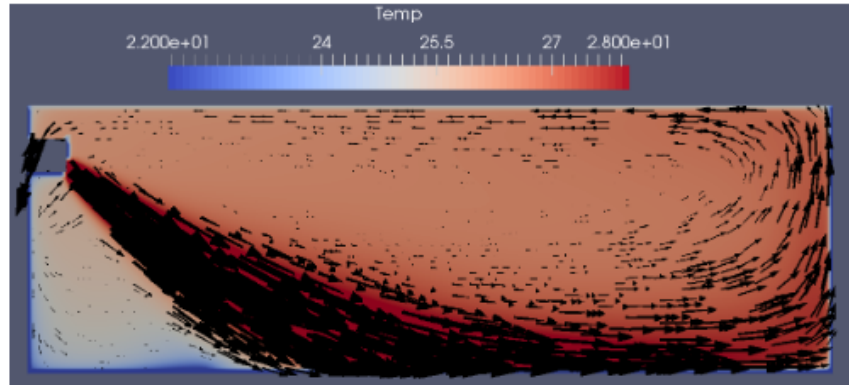

speed, and angle. The multi-objective function constitutes of the temperature uniformity of the room and average wind in the room in a region of interest as representative of thermal comfort, and a function of coefficient of performance (COP) as representative of the energy consumption of the RAC. Direct-adjoint-looping (DAL) method is used as the method for optimization, which is a gradient-based method. We also compared and analyzed the effects of various models of RACs on energy savings and comfort.

## Distribution System Fault Location Analysis Using Graph Neural Network

Citation: Sun, H., Kawano, S., Nikovski, D.N., Takano, T., Mori, K., "Distribution system fault location analysis using graph neural network with node and link attributes", IEEE PES Innovative Smart Grid Technologies Conference - Europe (ISGT Europe), October 2021.  
Contacts: Hongbo Sun, Daniel N. Nikovski

This paper presents a graph neural network-based fault location method for distribution systems, in which both link attributes and node attributes are considered. The proposed method integrates multiple measurements at different buses with branch parameters at different branches as inputs of the GNN, and transforms fault locations on branches into output features of corresponding connected nodes for the faulted branch. Besides the system topology that can be naturally considered by the GNN, the branch parameters and related regulation and energization statuses are explicitly taken into account as link attributes. Numerical examples are provided to demonstrate the usage of the proposed method.

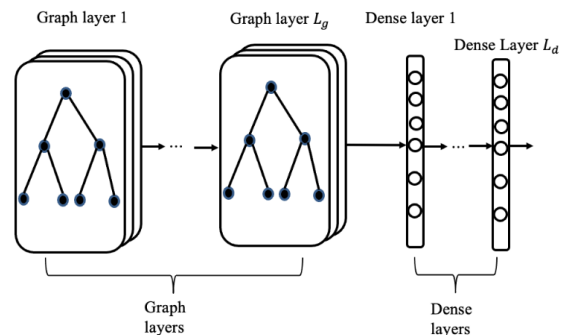

# SDP-Quality Bounds for Optimization of Mixed-Integer Quadratic Programs

Citation: Nohra, C.J., Raghunathan, A., Sahinidis, N.V., "SDP-quality bounds via convex quadratic relaxations for global optimization of mixed-integer quadratic programs", *Mathematical Programming B*, December 2021.

Contacts: Arvind Raghunathan

We consider the global optimization of nonconvex mixed-integer quadratic programs with linear constraints. We present a new class of convex quadratic relaxations which are derived via convex quadratic cuts. To construct these quadratic cuts, we solve a separation problem involving a linear matrix inequality with a special structure that allows the use of specialized solution algorithms. Our relaxations are an outer approximation of a semi-infinite convex program which under certain conditions is equivalent to a well-known semidefinite program relaxation.

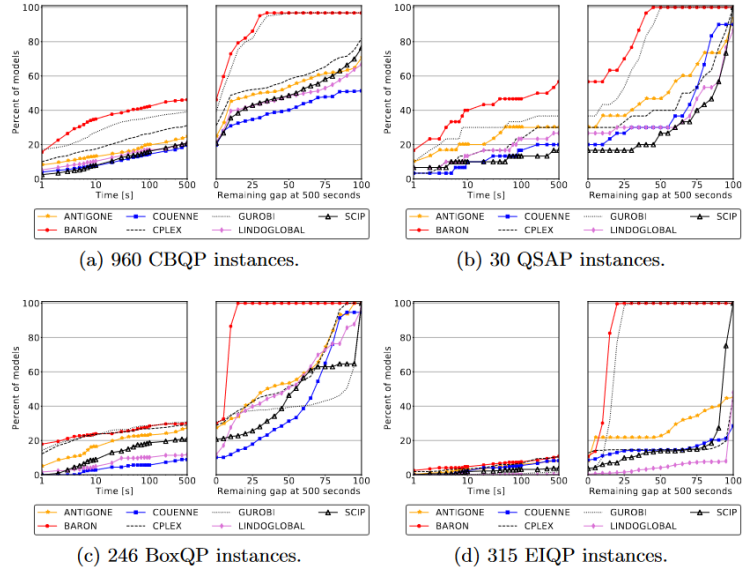

## Formulation of Convex Quadratic Programs for Infeasibility Detection

Citation: Raghunathan, A., "Homogeneous Formulation of Convex Quadratic Programs for Infeasibility Detection", *IEEE Conference on Decision and Control (CDC)*, DOI: 10.1109/CDC45484.2021.9682847, ISSN: 2576-2370, ISBN: 978-1-6654-3659-5, December 2021, pp. 968-973.

Contacts: Arvind Raghunathan

Convex Quadratic Programs (QPs) have come to play a central role in the computation of control action for constrained dynamical systems. Convex QPs arise in Model Predictive Control (MPC) for linear systems, switched linear systems and in sequential linearization of nonlinear systems. A number of algorithms have been developed in recent years for the solution of such QPs. However not all algorithms are capable of computing an optimal solution if feasible or producing a certificate of infeasibility. We present a novel Homogeneous QP (HQP) formulation, which is obtained by embedding the original QP in a larger space. The key properties of the HQP are: (i) is always feasible, (ii) an optimal solution to QP can be readily obtained from a solution to HQP, and (iii) infeasibility of QP corresponds to a particular solution of HQP.

---

### Algorithm 1: IIPM for HQP (17)

---

**Data:**  $\beta, \gamma, \sigma^{\min}, \sigma^{\max}$  with  $\beta \geq 1, \gamma \in (0, 1), 0 < \sigma^{\min} < \sigma^{\max} \leq \frac{1}{2}$ .

- 1 Choose  $(x^0, \lambda^0, s^0)$  with  $x^0, s^0 > 0$ .
  - 2 **for**  $k = 0, 1, \dots$  **do**
  - 3     Choose  $\sigma^k \in [\sigma^{\min}, \sigma^{\max}]$  and solve (21) to obtain  $(\Delta x^k, \Delta \lambda^k, \Delta s^k)$ .
  - 4     Choose the largest  $\alpha^k > 0$  such that (22) holds.
  - 5     Set  $(x^{k+1}, \lambda^{k+1}, s^{k+1}) = (x^k, \lambda^k, s^k) + \alpha^k (\Delta x^k, \Delta \lambda^k, \Delta s^k)$ .
-

# Automated Analog Circuit Design with Deep Reinforcement Learning

Citation: Cao, W., Benosman, M., Zhang, X., Ma, R., "Domain Knowledge-Based Automated Analog Circuit Design with Deep Reinforcement Learning", AAAI Conference on Artificial Intelligence, February 2022.

Contacts: Mouhacine Benosman

The design automation of analog circuits is a longstanding challenge in the integrated circuit field. This paper presents a deep reinforcement learning method to expedite the design of analog circuits at the pre-layout stage,

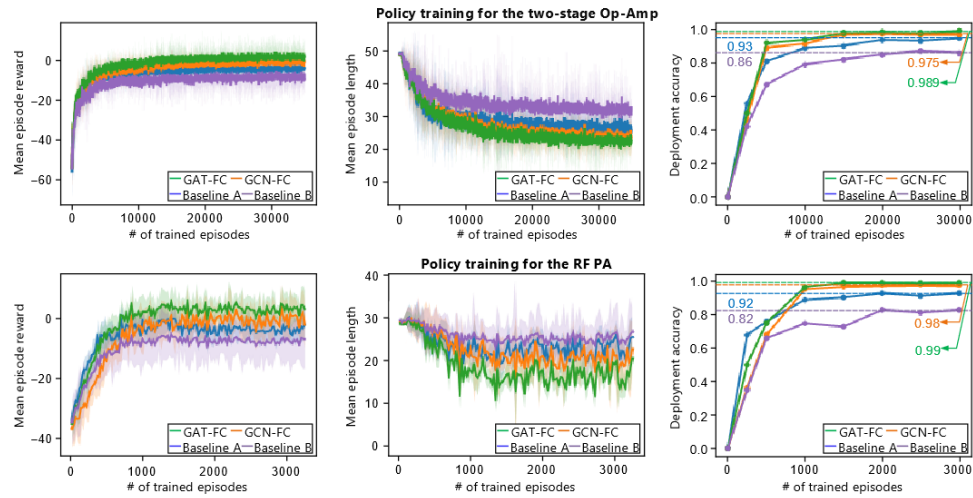

where the goal is to find device parameters to fulfill desired circuit specifications. Our approach is inspired by experienced human designers who rely on domain knowledge of analog circuit design (e.g., circuit topology and couplings between circuit specifications) to tackle the problem. Unlike all prior methods, our method originally incorporates such key domain knowledge into policy learning with a graph-based policy network, thereby best modeling the relations between circuit parameters and design targets. Experimental results on exemplary circuits show it achieves human-level design accuracy (99%) with 1.5x efficiency of existing best-performing methods. Our method also shows better generalization ability to unseen specifications and optimality in circuit performance optimization. Moreover, it applies to designing diverse analog circuits across different semiconductor technologies, breaking the limitations of prior ad-hoc methods in designing one particular type of analog circuits with conventional semiconductor technology.

# Connectivity & Information Processing

Connectivity research focuses on enhancing the performance and security of communications networks, particularly at network and system levels. Current areas of research include heterogenous IoT networking for smart infrastructure; reconfigurable networks; cyber security; and intelligent meta-surfaces for communications networks.

Information processing research areas include fundamental methods to enhance the robustness of machine learning methods; distributed learning methods such as federated learning; bio-signal processing; and quantum machine learning. Applications include security for cyber physical systems, collaborative learning for connected automated vehicles, and man-machine interfaces with multi-modal bio-sensors.

## Recent research

- Coexistence of IEEE 802.11ah and IEEE 802.15.4g Systems ..... 60
- Protograph-Based Design for QC Polar Codes..... 60
- Soft-Disentangled Universal Physiological Representation Learning ..... 61
- Overhead Reduction for Graph-Based Point Cloud Delivery ..... 61
- Sub-1 GHz Frequency Band Wireless Coexistence for the Internet of Things ..... 62
- Dynamic Transmission Scheduling for Wireless Networked Control Systems ..... 62
- Nano-Optic Broadband Power Splitter Design ..... 63
- Multi-Task Federated Learning for Traffic Prediction ..... 63
- Robust Machine Learning via Privacy/Rate-Distortion Theory..... 64
- Reconfigurable Intelligent Surface-Assisted Spatial Scattering Modulation ..... 64

## Coexistence of IEEE 802.11ah and IEEE 802.15.4g Systems

Citation: Nagai, Y., Sumi, T., Guo, J., Orlik, P.V., Mineno, H., "IEEE 802.19.3 Standardization for Coexistence of IEEE 802.11ah and IEEE 802.15.4g Systems in Sub-1 GHz Frequency Bands", Information Processing Society of Japan/Consumer Device and System Transaction, Vol. 11, No. 5, May 2021.

Contacts: Jianlin Guo, Philip V. Orlik

IEEE 802.11ah and IEEE 802.15.4g are two wireless technologies designed for outdoor IoT applications and installed on consumer devices and systems, for which both technologies operate in frequencies below 1 GHz. In addition, both technologies have communication range up to 1000 meters. Therefore, IEEE 802.11ah and IEEE 802.15.4g networks are likely to coexist. Our simulation results using standard defined coexistence mechanisms show that an IEEE 802.11ah network can severely interfere with IEEE 802.15.4g network and lead to significant packet loss in IEEE 802.15.4g network. The authors of this paper have been actively leading IEEE 802.19.3 standardization activities to address coexistence issues of IEEE 802.11ah and IEEE 802.15.4g systems. This paper summarizes our technical contributions for interference mitigation.

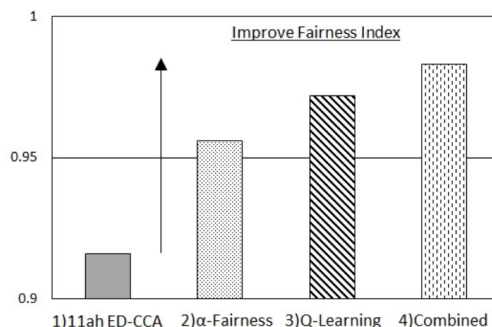

## Protograph-Based Design for QC Polar Codes

Citation: Koike-Akino, T., Wang, Y., "Protograph-Based Design for QC Polar Codes", IEEE International Symposium on Information Theory (ISIT), DOI: 10.1109/ISIT45174.2021.9517868, ISBN: 978-1-5386-8209-8, July 2021.

Contacts: Toshiaki Koike-Akino, Ye Wang

We propose a new family of polar codes to realize high coding gain, low complexity, and high throughput by introducing a protograph-based design. Our proposed technique, called quasi-cyclic (QC) polar codes, can be highly parallelized without sacrificing decoding complexity. We analyze short cycles in the protograph polar codes and develop a design method to increase the girth. Our approach can resolve the long-standing unsolved problem that belief propagation (BP) decoding does not work well for polar codes due to the inherently short cycles. We demonstrate that a high lifting factor of QC polar codes can improve performance and that QC polar codes with BP decoding can outperform conventional polar codes with state-of-the-art list decoding.

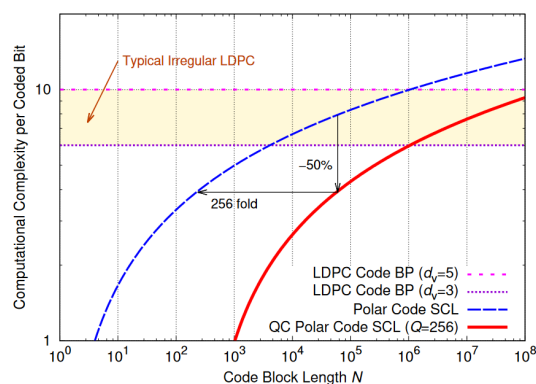



## Soft-Disentangled Universal Physiological Representation Learning

Citation: Han, M., Ozdenizci, O., Koike-Akino, T., Wang, Y., Erdogmus, D., "Universal Physiological Representation Learning with Soft-Disentangled Rateless Autoencoders", IEEE Journal of Biomedical and Health Informatics, DOI: 10.1109/JBHI.2021.3062335, ISSN: 2168-2208, Vol. 25, No. 8, pp. 2928-2937, April 2021.

Contacts: Toshiaki Koike-Akino, Ye Wang

Human computer interaction (HCI) involves a multidisciplinary fusion of technologies, through which the control of external devices could be achieved by monitoring physiological status of users. However, physiological biosignals often vary across users and recording sessions due to unstable physical/mental conditions and task-irrelevant activities. To deal with this challenge, we propose a method of adversarial feature encoding with the concept of a Rateless Autoencoder (RAE), in order to exploit disentangled, nuisance-robustness, and universal representations. We achieve a good trade-off between user-specific and task-relevant features by making use of the stochastic disentanglement of the latent representations by adopting additional adversarial networks.

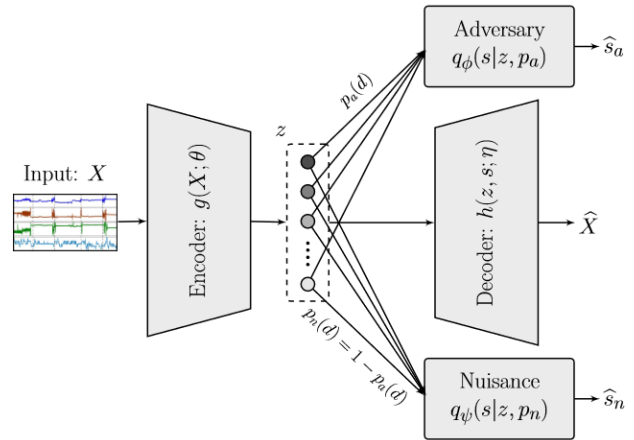

## Overhead Reduction for Graph-Based Point Cloud Delivery

Citation: Fujihashi, T., Koike-Akino, T., Watanabe, T., "Overhead Reduction for Graph-Based Point Cloud Delivery Using Non-Uniform Quantization", IEEE International Conference on Consumer Electronics (ICCE), DOI: 10.1109/ICCE53296.2022.9730509, ISSN: 2158-4001, ISBN: 978-1-6654-4154-4, January 2022.

Contacts: Toshiaki Koike-Akino

Graph-based compression can compact the signal energy of a three-dimensional (3D) point cloud and realize high-quality 3D point cloud delivery over wireless channels. However, it requires significant communication overhead of a graph Fourier transform (GFT) orthogonal matrix. For significant overhead reduction, our scheme integrates two methods: Givens rotation and non-uniform quantization. The Givens rotation transforms the GFT orthogonal matrix into angle parameters. The angle parameters are then non-uniformly quantized based on an empirical concave cumulative distribution function (CDF).

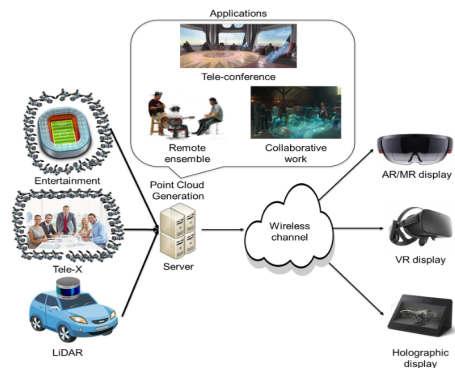

## Sub-1 GHz Frequency Band Wireless Coexistence for the Internet of Things

Citation: Nagai, Y., Guo, J., Orlik, P.V., Sumi, T., Rolfe, B.A. Mineno, H., "Sub-1 GHz Frequency Band Wireless Coexistence for the Internet of Things", IEEE Access, Vol. 9, September 2021.

Contacts: Jianlin Guo, Philip V. Orlik

Motivated by the explosion of the Internet of Things (IoT), we examined Sub-1 GHz band wireless technologies that are essential to enable various IoT applications. IEEE 802.15.4g and IEEE 802.11ah are two wireless technologies developed for outdoor IoT applications such as smart utility, smart city and infrastructure monitoring for which both technologies operate in Sub1 GHz Bands. Our coexistence simulation of IEEE 802.15.4g and IEEE 802.11ah using standard defined coexistence mechanisms shows serious interference problems due to fundamental protocol differences and channel access parameter differences. We propose a novel Active Carrier Sense based CSMA/CA mechanism for IEEE 802.15.4g to reduce CSMA/CA failure packet discard under interference from IEEE 802.11ah traffic and to keep interoperability with conventional IEEE 802.15.4g CSMA/CA mechanism.

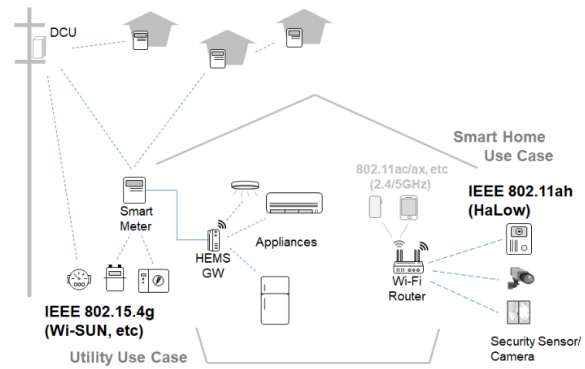

## Dynamic Transmission Scheduling for Wireless Networked Control Systems

Citation: Ma, Y., Guo, J., Wang, Y., Chakrabarty, A., Ahn, H., Orlik, P.V., Guan, X., Lu, C., "Optimal Dynamic Transmission Scheduling for Wireless Networked Control Systems", IEEE Transaction on Control Systems Technology, DOI: 10.1109/TCST.2022.3141581, January 2022

Contacts: Jianlin Guo, Yebin Wang, Ankush Chakrabarty, Philip V. Orlik

Wireless networked control systems (WNCS) have the potential to revolutionize industrial automation in smart factories. Optimizing closed-loop performance while maintaining stability is a fundamental challenge in WNCS due to limited bandwidth and non-

deterministic link quality of wireless networks. In order to bridge the gap between network design and control system performance, we propose a dynamic transmission scheduling strategy that optimizes performance of multi-loop control systems by allocating network resources based on predictions of both link quality and control performance at run-time.

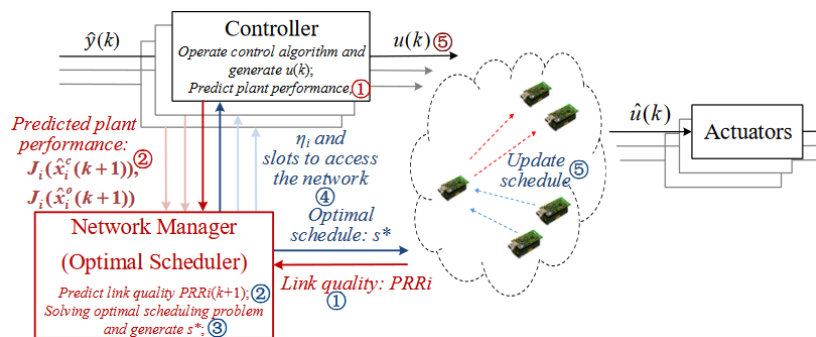

## Nano-Optic Broadband Power Splitter Design

- Citation: Tang, Y., Kojima, K., Koike-Akino, T., Wang, Y., Jha, D.K., Parsons, K., Qi, M., "Nano-Optic Broadband Power Splitter Design via Cycle-Consistent Adversarial Deep Learning", Conference on Lasers and Electro-Optics (CLEO), DOI: 10.1364/CLEO\_SI.2021.SW4E.1, May 2021.
- Contacts: Toshiaki Koike-Akino, Ye Wang, Devesh K. Jha, Kieran Parsons

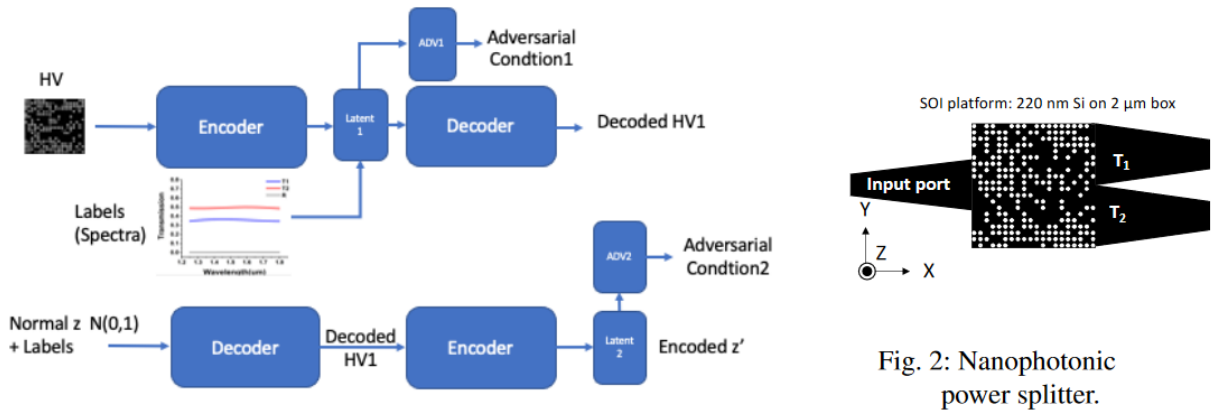

A generative deep learning model with a cycle-consistent adversarial network is introduced for optimizing 550 nm broad bandwidth power splitters with arbitrary target splitting ratios.

## Multi-Task Federated Learning for Traffic Prediction

- Citation: Zeng, T., Guo, J., Kim, K.J., Parsons, K., Orlik, P.V., Di Cairano, S., Saad, W., "Multi-Task Federated Learning for Traffic Prediction and Its Application to Route Planning", IEEE Intelligent Vehicles Symposium, July 2021.
- Contacts: Jianlin Guo, Kyeong Jin Kim, Kieran Parsons, Philip V. Orlik, Stefano Di Cairano

A novel multi-task federated learning (FL) framework is proposed to optimize traffic prediction models without sharing collected data among traffic stations. A divisive hierarchical clustering is first introduced to partition the collected traffic data at

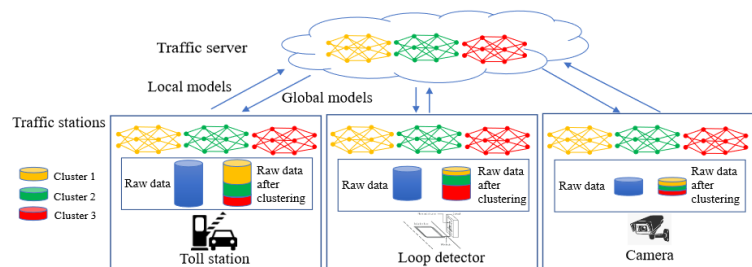

each station into different clusters. The FL is then implemented to collaboratively train the learning model for each cluster of local data distributed across the stations. Using the multi-task FL framework, the route planning is studied where the road map is modeled as a time-dependent graph and a modified A\* algorithm is used to determine the route with the shortest traveling time. Simulation results showcase the prediction accuracy improvement of the proposed multi-task FL framework over two baseline schemes.

## Robust Machine Learning via Privacy/Rate-Distortion Theory

Citation: Wang, Y., Aeron, S., Rakin, A.S., Koike-Akino, T., Moulin, P., "Robust Machine Learning via Privacy/Rate-Distortion Theory", IEEE International Symposium on Information Theory (ISIT), DOI: 10.1109/ISIT45174.2021.9517751, ISBN: 978-1-5386-8210-4, July 2021.

Contacts: Ye Wang, Toshiaki Koike-Akino

Robust machine learning formulations have emerged to address the prevalent vulnerability of deep neural networks to adversarial examples. Our work draws the connection between optimal robust learning and the privacy/utility tradeoff problem, which is a generalization of the rate-distortion problem. The saddle point of the game between a robust classifier and an adversarial perturbation can be found via the solution of a maximum conditional entropy problem. This information-theoretic perspective sheds light on the fundamental tradeoff between robustness and clean data performance, which ultimately arises from the geometric structure of the underlying data distribution and perturbation constraints.

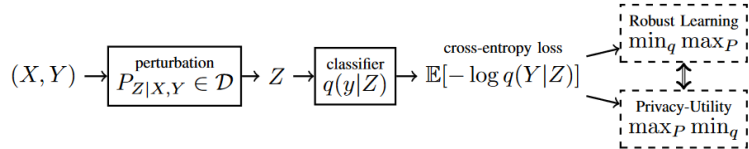

## Reconfigurable Intelligent Surface-Assisted Spatial Scattering Modulation

Citation: Zhu, X., Yuan, L., Kim, K.J., Li, Q., Zhang, J., "Reconfigurable Intelligent Surface-Assisted Spatial Scattering Modulation", IEEE Communications Letters, January 2022.

Contacts: Kyeong Jin Kim

Reconfigurable intelligent surface (RIS) and spatial scattering modulation (SSM) are promising candidates for future generations of wireless communication. The former provides an enhanced transmission environment by providing an alternative communication path, while the latter boosts the spectral efficiency. In this letter, we firstly propose a novel uplink millimeterwave (mmWave) communication system that utilizes both RIS and SSM to support data transmission over wireless channels. We design the reflecting phase shifters at the RIS to maximize the signal-to-noise ratio of the two-hop communications. Moreover, a maximum likelihood detector is adopted to a new system with RIS-SSM and a new closed-form expression for a tight union upper bound on the bit error rate (BER) is derived. Monte Carlo simulation results are provided to verify the accuracy of the derived analytical expression. Numerical results reveal that the proposed RIS-SSM scheme has a significantly lower BER than traditional SSM.

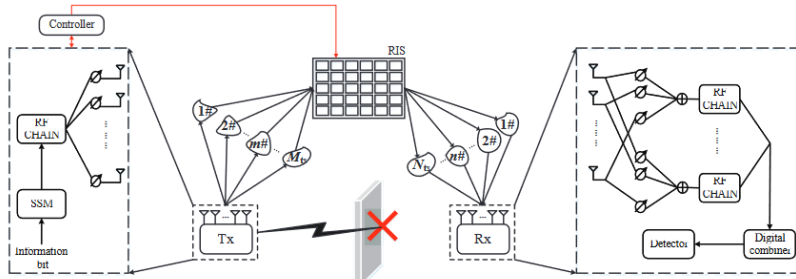

# Computational Sensing

Our research in computational sensing focuses on signal acquisition and design, signal modeling and reconstruction algorithms, including inverse problems, as well as imaging and array signal processing techniques. We explore novel architectures for signal acquisition and sensing, methods to acquire and filter signals in the presence of noise and other degrading factors, techniques that fuse signals from multiple sensing modalities, and approaches to infer meaning from processed signals. Our work has applications to product areas such as autonomous vehicles, factory automation, navigation systems, automotive radars, public security, non-contact sensing and radar imaging, among others. Our research agenda combines state-of-the art theoretical developments with widely available computational power to overhaul the signal acquisition pipeline, significantly enhance sensing capabilities, and improve inference systems that seek to understand signal propagation and behavior.

## Recent research

- Reflection Tomographic Imaging of Highly Scattering Objects.....66
- Hand Graph Representations for Segmentation of Complex Activities.....66
- Multiview Sensing with Unknown Permutations.....67
- Fingerprinting-Based Indoor Localization with Commercial WiFi .....67
- A Consensus Equilibrium Solution for Deep Image Prior Powered by Red.....68
- Learning-Based Shadow Mitigation for Terahertz Multi-Layer Imaging.....68
- Fast and High-Quality Blind Multi-Spectral Image Pansharpener.....69
- Extended Object Tracking with Automotive Radar .....69
- Automotive Radar Interference Mitigation .....70

## Reflection Tomographic Imaging of Highly Scattering Objects

Citation: Kadu, A., Mansour, H., Boufounos, P.T., Liu, D., "Reflection Tomographic Imaging of Highly Scattering Objects Using Incremental Frequency Inversion", IEEE International Conference on Acoustics, Speech, and Signal Processing (ICASSP), May 2019

Contacts: Hassan Mansour, Petros Boufounos, Dehong Liu

Reflection tomography is an inverse scattering technique that estimates the spatial distribution of an object's permittivity by illuminating it with a probing pulse and measuring the scattered wavefields by receivers located on the same side as the transmitter. Unlike conventional transmission tomography, the reflection regime is severely illposed since the measured wavefields contain far less spatial frequency information about the object. We propose an incremental frequency inversion framework that requires no initial target model, and that leverages spatial regularization to reconstruct the permittivity distribution of highly scattering objects. Our framework solves a wave-equation constrained, total-variation (TV) regularized nonlinear least squares problem that solves a sequence of subproblems that incrementally enhance the resolution of the estimated object model. With each subproblem, higher frequency wavefield components are incorporated in the inversion to improve the recovered model resolution.

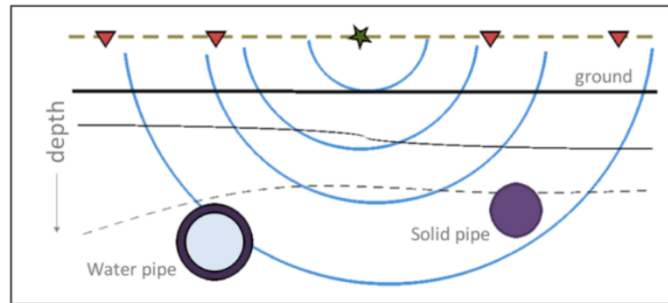

## Hand Graph Representations for Segmentation of Complex Activities

Citation: Das, P., Kao, J.-Y., Ortega, A., Mansour, H., Vetro, A., Sawada, T., Minezawa, A., "Hand Graph Representations for Unsupervised Segmentation of Complex Activities", IEEE International Conference on Acoustics, Speech, and Signal Processing (ICASSP), May 2019.

Contacts: Hassan Mansour, Anthony Vetro

Analysis of hand skeleton data can be used to understand patterns in manipulation and assembly tasks. This paper introduces a graph-based representation of hand skeleton data and proposes a method to perform unsupervised temporal segmentation of a sequence of subtasks in order to evaluate the efficiency of an assembly task. We explore the properties of different choices of hand graphs and their spectral decomposition. A comparative performance of these graphs is presented in the context of complex activity segmentation. We show that the spectral graph features extracted from 2D hand motion data outperform the direct use of motion vectors as features.

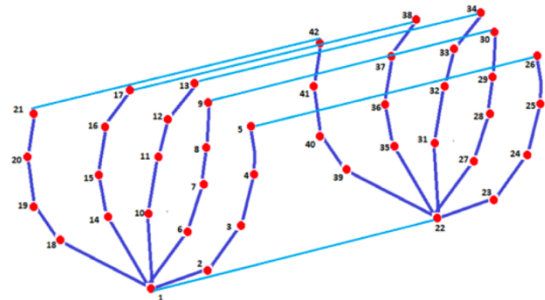

## Multiview Sensing with Unknown Permutations

Citation: Ma, Y., Boufounos, P.T., Mansour, H., Aeron, S., "Multiview Sensing with Unknown Permutations: An Optimal Transport Approach", IEEE International Conference on Acoustics, Speech, and Signal Processing (ICASSP), DOI: 10.1109/ICASSP39728.2021.9415075, June 2021, pp. 1440-1444.

Contacts: Yanting Ma, Petro T. Boufounos, Hassan Mansour

In several applications, including imaging of deformable objects while in motion, simultaneous localization and mapping, and unlabeled sensing, we encounter the problem of recovering a signal that is measured subject to unknown permutations. In this paper we take a fresh look at this problem through the lens of optimal transport (OT). In particular, we recognize that in most practical applications the unknown permutations are not arbitrary but some are more likely to occur than others. We exploit this by introducing a regularization function that promotes the more likely permutations in the solution. We show that, even though the general problem is not convex, an appropriate relaxation of the resulting regularized problem allows us to exploit the well-developed machinery of OT and develop a tractable algorithm.

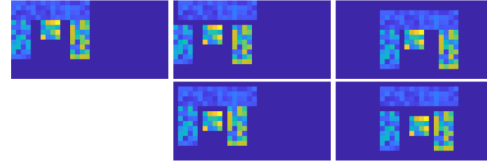

Fig. 1. Illustrative example of our set up. Left: Signal  $x$ . Middle and Right: (top) estimates  $F_i x$  of two different permutations of  $x$ , (bottom) actual permutations  $x_i = P_i F_i x$  of  $x$  observed by the acquisition system.

## Fingerprinting-Based Indoor Localization with Commercial WiFi

Citation: Koike-Akino, T., Wang, P., Pajovic, M., Sun, H., Orlik, P.V., "FingerprintingBased Indoor Localization with Commercial MMWave WiFi: A Deep Learning Approach", IEEE Access, April 2020.

Contacts: Toshiaki Koike-Akino, Pu Wang, Philip V. Orlik

Existing fingerprint-based indoor localization uses either fine-grained channel state information (CSI) from the physical layer or coarse-grained received signal strength indicator (RSSI) measurements. We propose to use a mid-grained intermediate-level channel measurement (spatial beam signal-to-noise ratios (SNRs) that are inherently available and defined in the IEEE 802.11ad/ay standards) to construct the fingerprinting database.

These intermediate channel measurements are further utilized by a deep learning approach for multiple purposes: 1) location-only classification; 2) simultaneous location and orientation classification; and 3) direct coordinate estimation.



## A Consensus Equilibrium Solution for Deep Image Prior Powered by Red

Citation: Hyder, R., Mansour, H., Ma, Y., Boufounos, P.T., Wang, P., "A Consensus Equilibrium Solution for Deep Image Prior Powered by Red", IEEE International Conference on Acoustics, Speech, and Signal Processing (ICASSP), DOI: 10.1109/ICASSP39728.2021.9414290, June 2021, pp. 1380-1384.

Contacts: Hassan Mansour, Yanting Ma, Petros T. Boufounos, Pu Wang

Recent advances in solving imaging inverse problems have witnessed the combination of deep learning models with classical image models for better signal representation. One such approach, DeepRED, combines the deep image prior (DIP) with the regularization by denoising (RED) framework to boost the performance of image deblurring and super resolution tasks. In this paper, we formulate DeepRED as a consensus equilibrium problem and set up a fixed-point algorithm for solving the equilibrium equations. We also derive

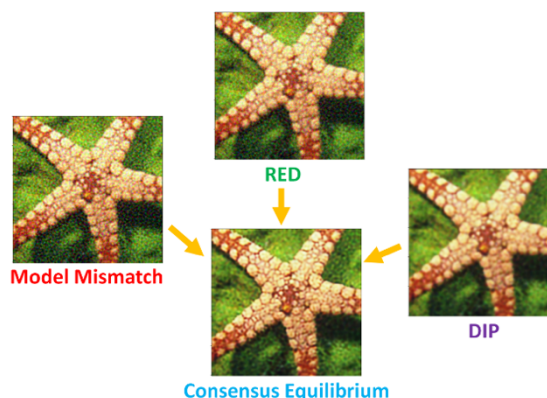

sufficient conditions that the DIP generative prior should satisfy to ensure that the corresponding fixed-point operator is non-expansive. We then demonstrate that the fixed-point algorithm that solves the CE equations results in improved image reconstruction quality in a deblurring setting compared to state-of-the-art methods

## Learning-Based Shadow Mitigation for Terahertz Multi-Layer Imaging

Citation: Wang, P., Koike-Akino, T., Bose, A., Ma, R., Orlik, P.V., Tsujita, W., Sadamoto, K., Tsutada, H., Soltanian, M., "Learning-Based Shadow Mitigation for Terahertz Multi-Layer Imaging", International Conference on Infrared, Millimeter, and Terahertz Waves (IRMMW-THz), September 2019.

Contacts: Pu Wang, Toshi Koike-Akino, Rui Ma

This paper proposes a learning-based approach to mitigate the shadow effect in the pixel domain for Terahertz Time Domain Spectroscopy (THz-TDS) multilayer imaging. Compared with model-based approaches, this learning-based approach requires no prior knowledge of material properties of the sample. Preliminary simulations confirm the effectiveness of the proposed method.

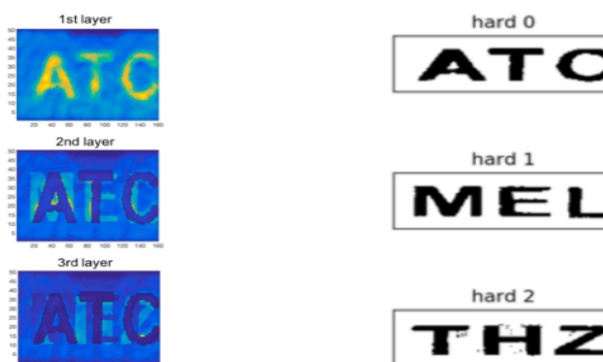



## Fast and High-Quality Blind Multi-Spectral Image Pansharpener

Citation: Yu, L., Liu, D., Mansour, H., Boufounos, P.T., "Fast and High-Quality Blind Multi-Spectral Image Pansharpener", IEEE Transactions on Geoscience and Remote Sensing, DOI: 10.1109/TGRS.2021.3091329, Vol. 60, pp. 1-17, January 2022.

Contacts: Dehong Liu, Hassan Mansour, Petros T. Boufounos

Blind pan-sharpener addresses the problem of generating a high spatial-resolution multi-spectral (HRMS) image given a low spatial-resolution multi-spectral (LRMS) image with the guidance of its associated spatially misaligned high spatial-resolution panchromatic (PAN) image without parametric side information. Blind pan-sharpener algorithms are often computationally intensive since the blur kernel and the target HRMS image are computed using iterative solvers and in an alternating fashion. To achieve fast blind pan-sharpener, we first estimate the blur kernel by computing the kernel coefficients with minimum total generalized variation that blur a down-sampled version of the PAN image to approximate a linear combination of the LRMS image channels. Then, we estimate each channel of the HRMS image using a local Laplacian prior to regularize the relationship between each HRMS channel and the PAN image.

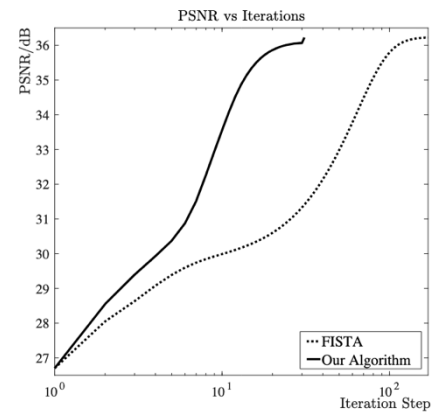

## Extended Object Tracking with Automotive Radar

Citation: Yao, G., Wang, P., Berntorp, K., Mansour, H., Boufounos, P.T., Orlik, P.V., "Extended Object Tracking with Automotive Radar Using B-Spline Chained Ellipses Model", IEEE International Conference on Acoustics, Speech, and Signal Processing (ICASSP), DOI: 10.1109/ICASSP39728.2021.9415080, June 2021, pp. 8408-8412.

Contacts: Pu Wang, Karl Berntorp, Hassan Mansour, Petros T. Boufounos, Philip V. Orlik

This paper introduces a B-spline chained ellipses model representation for extended object tracking (EOT) using high-resolution automotive radar measurements. With offline automotive radar training datasets, the proposed model parameters are learned using the expectation-maximization (EM) algorithm. Then the probabilistic multi-hypothesis tracking (PMHT) along with the unscented transform (UT) is proposed to deal with the nonlinear forward-warping coordinate transformation, the measurement-to-ellipse association, and the state update step.

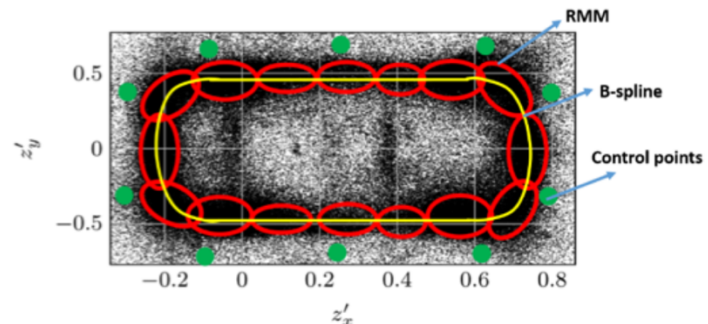

## Automotive Radar Interference Mitigation

Citation: Jin, S., Pu, W., Boufounos, P.T., Orlik, P.V., Roy, S., "Automotive Radar Interference Mitigation with Fast-Time-Frequency Mode Retrieval", IEEE Radar Conference (RadarCon), March 2022.

Contacts: Pu Wang, Petros T. Boufounos, Philip V. Orlik

This paper considers mutual interference mitigation (MIM) for frequency modulated continuous wave (FMCW) automotive radar. Particularly, we exploit distinguished features of target and interference components in the fast-time-frequency (fTF) representation and, as opposed to existing fast-time MIM methods on nulling the interference component, propose to directly recover the underwhelmed target component via the fast-time-frequency mode retrieval (fTFMR). This is achieved by utilizing the Fourier synchro-squeezed transform (FSST) and introducing robust ridge detection that, in combination, guarantees that the recovered fast-time errors of the target signal are bounded at separable time intervals. Comprehensive performance comparison with a list of baseline methods shows that the proposed MIM method yields higher output signal-to-interference-noise ratios (SINRs) at both the range and velocity domains and reduces the false alarm.

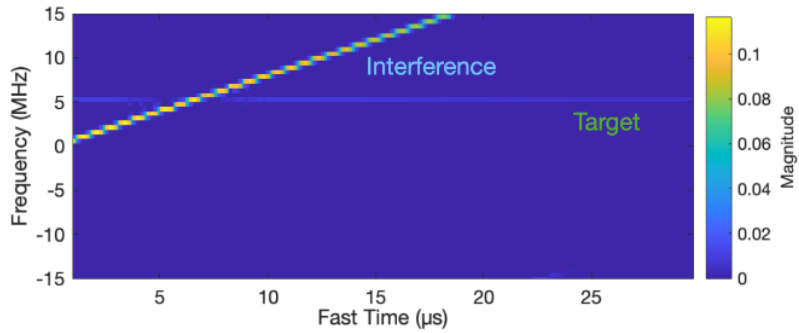

(a) High-resolution fTF representation using FSST

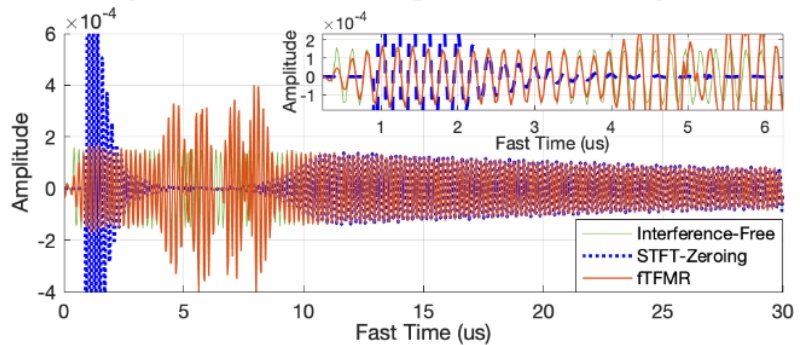

(b) Recovered fast-time target signals using STFT-zeroing [7] and proposed fTFMR

# Control for Autonomy

Autonomous mobile systems, such as automated cars, transport and inspection drones, robotic spacecrafts, and zoomorphic robots, show promises to improve safety, efficiency, and life enjoyment in tomorrow’s society. At the core of highly capable autonomous systems there are advanced algorithms that estimate reliable information on the system operation and its surrounding environment, determine effective actions and motion plans, and control the system to robustly execute such desired behaviors. MERL’s research focuses on developing advanced estimation, planning, and control algorithms for autonomous systems that increase the capabilities, the performance, and the robustness with respect state-of-the-art in academia and industry, yet they require limited resources in terms of computations and memory, to be viable for mass production. Recent results of MERL algorithms include safe and robust vehicle control and motion planning for automated vehicles, high precision GNSS positioning, reliable statistical estimation of vehicle driving conditions, fault tolerant spacecraft rendezvous control, fast planning for teams of drones, energy management of electric vehicles. MERL fundamental research in control theory with general applicability has a strong focus on model predictive control, statistical estimation, constrained control, motion planning, stochastic control, integration of learning and control, and real-time optimization for control.

## Recent research

- Reachability-based Decision Making for Autonomous Driving ..... 72
- Adaptive Stochastic Nonlinear Model Predictive Control for Vehicles ..... 72
- Uncertainty Propagation by Linear Regression Kalman Filters for NMPC ..... 73
- Kernel Regression for Energy-Optimal Control of Fully Electric Vehicles ..... 73
- Fail-Safe Spacecraft Rendezvous on Near-Rectilinear Halo Orbits ..... 74
- PRESAS: Iterative Solvers within a Primal Active-Set Method for fast MPC ..... 74
- Mixed-Integer Linear Regression Kalman Filters for GNSS Positioning ..... 75
- Bayesian Inference and Learning of Gaussian-Process State-Space Models ..... 75
- Perception-Aware Chance-Constrained Model Predictive Control ..... 76

## Reachability-based Decision Making for Autonomous Driving

Citation: Ahn, H., Berntorp, K., Inani, P., Ram, A.J., Di Cairano, S., "Reachability-based Decision Making for Autonomous Driving: Theory and Experiment", IEEE Transactions on Control Systems Technology, December 2020.

Contacts: Karl Berntorp, Stefano Di Cairano

We describe the design and validation of a decision making system in the guidance and control architecture for automated driving. The decision-making system determines the timing of transitions through a sequence of driving modes, such as lane following and stopping, for the vehicle to eventually arrive at the destination without colliding with obstacles. The decision-making system commands a transition to the next mode only when it is possible for an underlying motion planner to generate a feasible trajectory that reaches the target region of the next mode. Using forward and backward reachable sets based on a simplified dynamical model, the decision-making system determines the existence of a trajectory that reaches the target region, without actually computing it.

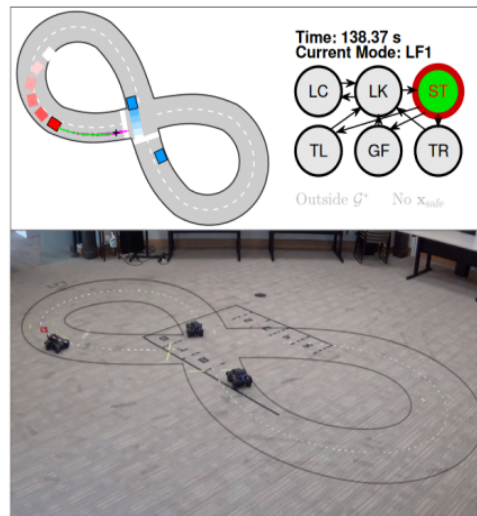

## Adaptive Stochastic Nonlinear Model Predictive Control for Vehicles

Citation: Vaskov, S., Quirynen, R., Berntorp, K., "Cornering Stiffness Adaptive, Stochastic Nonlinear Model Predictive Control for Vehicles", American Control Conference (ACC), DOI: 10.23919/ACC50511.2021.9482699, May 2021,

Contacts: Rien Quirynen, Karl Berntorp

The vehicle control behavior is highly dependent on the road surface. However, accurate and precise models for the tire-road interaction are typically unknown a priori. It is therefore important that the vehicle's control algorithm updates its tire-force model, to adapt to the changing conditions. We propose a stochastic nonlinear model-predictive control (SNMPC) scheme that uses a linear tire-force model, where the mean and covariance of the cornering stiffness parameters are estimated and updated online. We formulate constraints based on the stiffness estimates to ensure that the vehicle maintains stability on low-friction surfaces. In extensive simulations, where the road surface transitions from asphalt to snow, we compare the proposed controller with various MPC implementations; for example, the proposed approach reduces average closed-loop cost over 30% on aggressive maneuvers, when compared to a non-stochastic controller.

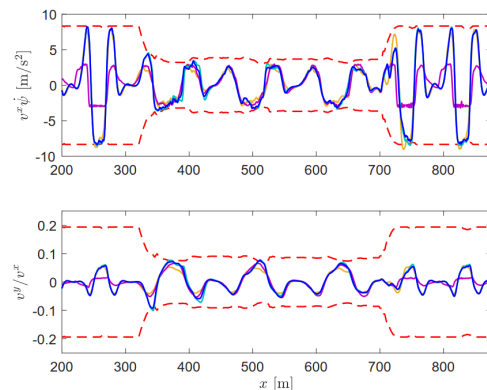

## Uncertainty Propagation by Linear Regression Kalman Filters for NMPC

Citation: Quirynen, R., Berntorp, K., "Uncertainty Propagation by Linear Regression Kalman Filters for Stochastic NMPC", IFAC Conference on Nonlinear Model Predictive Control, DOI: 10.1016/j.ifacol.2021.08.527, July 2021  
Contacts: Rien Quirynen, Karl Berntorp

Stochastic nonlinear model predictive control (SNMPC) allows one to directly take model uncertainty into account, e.g., by including probabilistic chance constraints. This paper proposes linear-regression Kalman filtering to perform high-accuracy propagation of mean and co-variance information for the nonlinear system dynamics in a tractable approximation of the stochastic optimal control problem. In addition, a tailored adjoint-based sequential quadratic programming (SQP) algorithm is presented to considerably reduce the computational cost and allow a real-time implementation of the resulting SNMPC.

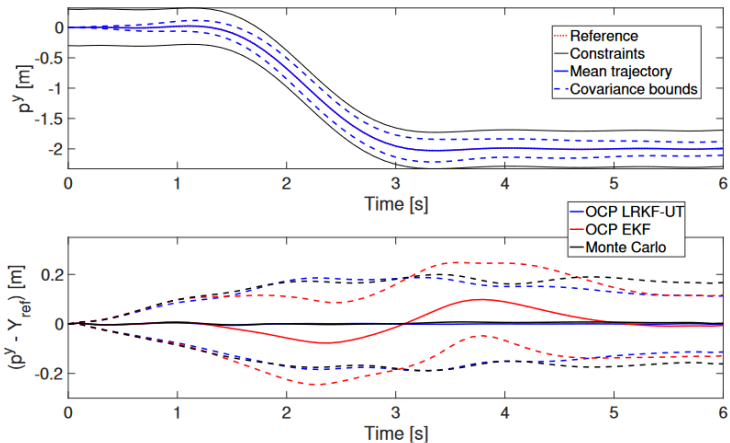

## Kernel Regression for Energy-Optimal Control of Fully Electric Vehicles

Citation: Menner, M., Di Cairano, S., "Kernel Regression for Energy-Optimal Control of Fully Electric Vehicles", IEEE Vehicle Power and Propulsion Conference, DOI: 10.1109/VPPC53923.2021.9699361, October 2021,  
Contacts: Marcel Menner, Stefano Di Cairano

This paper presents a control algorithm for electric vehicles (EVs) with multiple motors. The control algorithm minimizes the EV's energy usage by optimizing the efficiency of its electric motors. The degrees of freedom exploited by the control algorithm are the torque-split ratio between multiple motors, the gear ratio for transmission, as well as the velocity profile of the EV. The algorithm uses kernel regression to learn a pseudo-convex cost function for optimal control from tabulated data of the electric motors' efficiency maps. The main advantages of the algorithm are its real-time feasibility due to the pseudo-convex shape and its flexible approximation capabilities. A simulation study shows how an EV with multiple but different motors and a torque-split controller can efficiently exploit the range of operation of the individual motors.

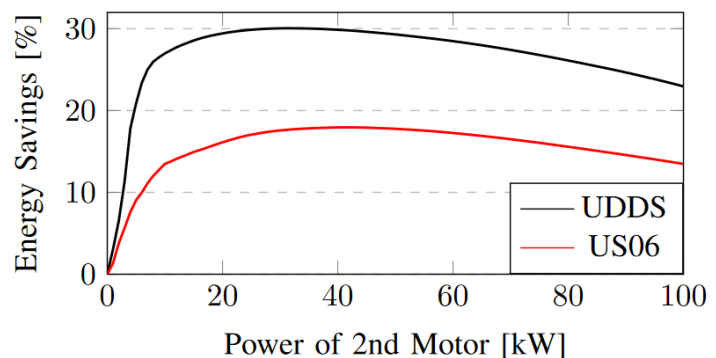

## Fail-Safe Spacecraft Rendezvous on Near-Rectilinear Halo Orbits

Citation: Aguilar Marsillach, D., Di Cairano, S., Kalabic, U., Weiss, A., "Fail-Safe Spacecraft Rendezvous on Near-Rectilinear Halo Orbits", American Control Conference (ACC), DOI: [10.23919/ACC50511.2021.9483328](https://doi.org/10.23919/ACC50511.2021.9483328), May 2021, pp. 2980-2985

Contacts: Stefano Di Cairano, Avishai Weiss

Future spacecraft missions require novel guidance and control policies that reduce fuel consumption, yield sparse thrust signals, and maintain mission safety even in the presence of faults. This paper presents an approach for rendezvous with a target in a near-rectilinear halo orbit that exploits the natural dynamics to reduce propellant consumption and ensures passive safety in the presence of thruster failure. A chaser spacecraft that aims to rendezvous with a target is steered into coasting sets while simultaneously maintaining passive safety by avoiding the states that naturally collide with the target. Upon entering the coasting sets, the chaser's thrusters are disengaged, as the natural dynamics lead it into a goal set. Abort-safety is then demonstrated during final approach from the goal set to the target. The target is modeled in a full-ephemeris, high-fidelity, and quasi-periodic near-rectilinear halo orbit.

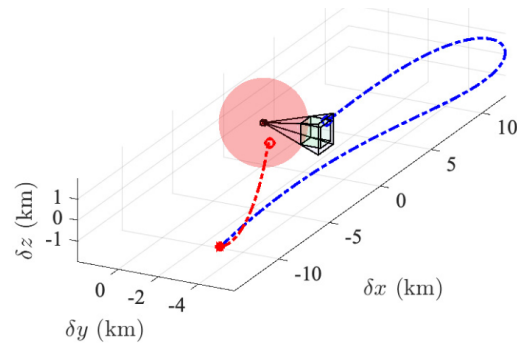

## PRESAS: Iterative Solvers within a Primal Active-Set Method for fast MPC

Citation: Quirynen, R., Di Cairano, S., "PRESAS: Block-Structured Preconditioning of Iterative Solvers within a Primal Active-Set Method for fast MPC", Optimal Control Applications & Methods, Vol. 41, No. 6, pp. 2282-2307, September 2020.

Contacts: Rien Quirynen, Stefano Di Cairano

Model predictive control (MPC) for linear dynamical systems requires solving an optimal control structured quadratic program (QP) at each sampling instant. This paper

proposes a primal active-set strategy, called PRESAS, for the efficient solution of such block-sparse QPs, based on a preconditioned iterative solver to compute the search direction in each iteration. Three different block-structured preconditioning techniques are presented and their numerical properties are studied further. In addition, an augmented Lagrangian based implementation is proposed to avoid a costly initialization procedure to find a primal feasible starting point.

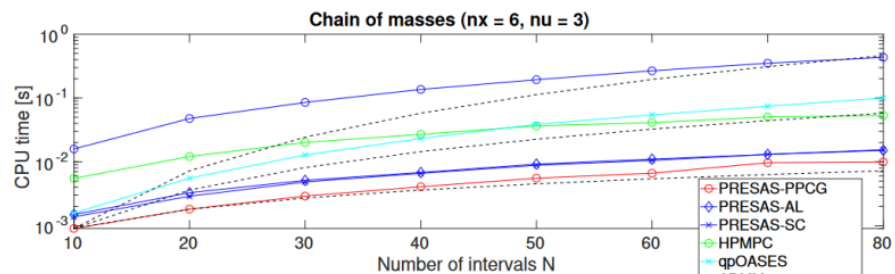

## Mixed-Integer Linear Regression Kalman Filters for GNSS Positioning

Citation: Greiff, M., Berntorp, K., Di Cairano, S., Kim, K.J., "Mixed-Integer Linear Regression Kalman Filters for GNSS Positioning", IEEE Conference on Control Technology and Applications (CCTA), DOI: 10.1109/CCTA48906.2021.9659142, August 2021.

Contacts: Karl Berntorp, Stefano Di Cairano, Marcus Greiff, Kyeong Jin Kim

In this paper, recursive filters are formulated for the mixed-integer GNSS receiver estimation problem, where the integer variables come from the ambiguities in the carrier-phase measurements. Insights from the linear setting illustrate pitfalls in designing optimal recursive filters, motivating a relaxation of the original optimization problem and a departure from conventional methods. A set of filters are developed for sequential nonlinear mixed-integer estimation based on statistical linearization, entertaining two estimate densities and taking the time-evolution of the ambiguities into account by adapting the process noise covariance based on a statistical model. Numerical examples illustrate the efficacy of the proposed algorithms.

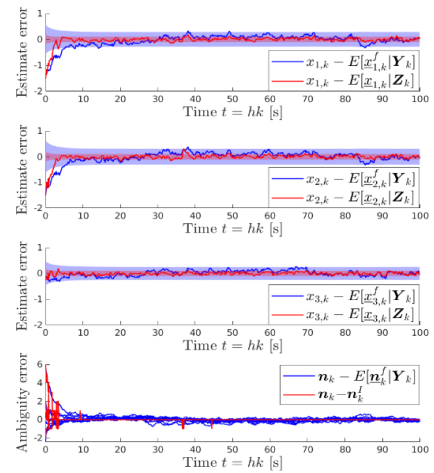

## Bayesian Inference and Learning of Gaussian-Process State-Space Models

Citation: Berntorp, K., "Online Bayesian Inference and Learning of Gaussian-Process State-Space Models", Automatica, Vol. 129, March 2021.

Contacts: Karl Berntorp

This paper addresses the recursive joint inference (state estimation) and learning (system identification) problem for nonlinear systems admitting a state-space formulation. We model the system as a Gaussian-process state-space model (GP-SSM) and leverage a recently developed reduced-rank formulation of GP-SSMs to enable efficient, online learning. The unknown dynamical system is expressed as a basis-function expansion, where a connection to the GP makes it possible to systematically assign priors to the basis-function weights. The approach is formulated within the sequential Monte-Carlo framework, wherein each particle retains its own weights of the basis functions, which are updated recursively as measurements arrive. We apply the method to a case study concerning tire-friction estimation. The results indicate that our method can accurately learn the tire friction using automotive-grade sensors in an online setting, and quickly detect sudden changes of the road surface.

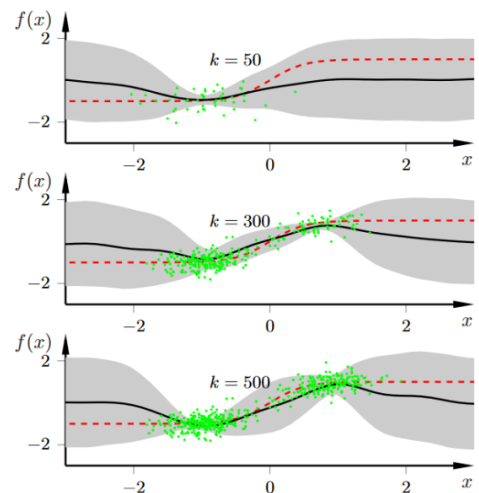

# Perception-Aware Chance-Constrained Model Predictive Control

Citation: Bonzanini, A.D., Mesbah, A., Di Cairano, S., "Perception-Aware Chance-Constrained Model Predictive Control for Uncertain Environments", American Control Conference (ACC), DOI: 10.23919/ACC50511.2021.9483203, May 2021.

Contacts: Stefano Di Cairano

We consider a known system that operates in an unknown environment, which is discovered by sensing and affects the known system through constraints. However, sensing quality is typically dependent on system operation. Thus, the control decisions should account for both the impact of control on sensing and the impact of sensing on control. Since the information acquired from sensing is of statistical nature, we develop a perception-aware chance-constrained model predictive control (PAC-MPC) strategy that leverages uncertainty propagation models to relate control and sensing decisions to the environment knowledge. We propose conditions for recursive feasibility and provide an overview of the stability properties in such a statistical framework. The performance of the proposed PAC-MPC is demonstrated on a case study inspired by an automated driving application.

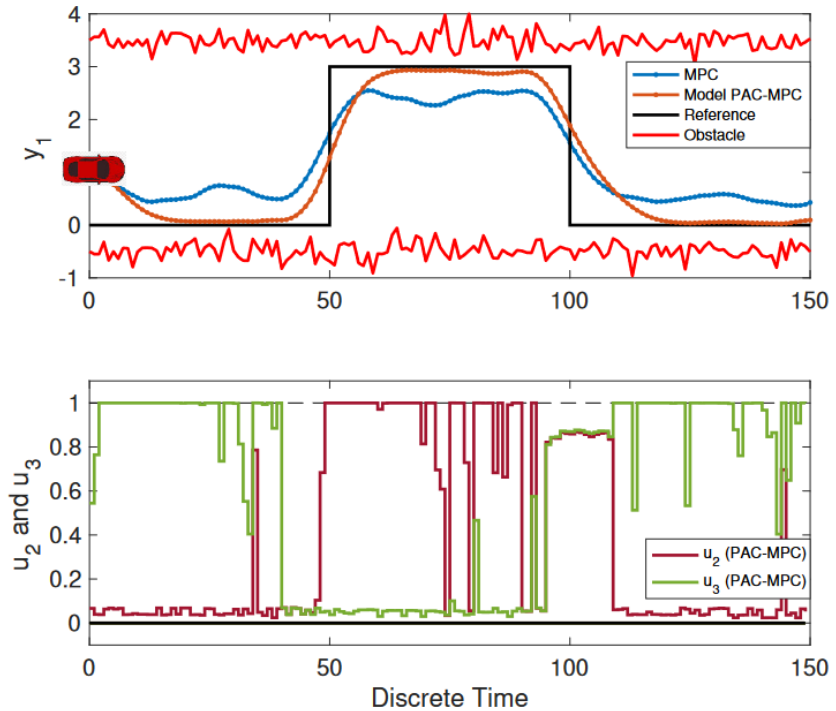



# Electric Machines & Devices

This area covers research on modeling & simulation, model-based design, optimal control, predictive maintenance and system integration of electric machines and devices. The multi-physical modeling serves as a foundation and is integrated with other technologies, such as signal processing, control, optimization, and machine learning to meet different application needs.

We investigate modeling fundamentals including fast computation methodologies with good accuracy via analytical magnetic modeling. The developed models can be utilized for model-based design of new motors to achieve high density and high torque, as well as parameter estimation for motor customization. For optimal control of electric machines, our effort is to develop the advanced control algorithms that can increase the performance and robustness with limited resources in terms of computations and memory. We apply the latest signal processing techniques, refined physical models, and in conjunction with data-driven learning methods to enable high-performance online condition monitoring. In the area of devices, we focus on emerging GaN technologies for power, RF, digital and quantum computing applications, and incorporating domain knowledge with machine learning to develop high accuracy and efficiency for integrated circuits. In addition, we spend some effort to explore modern quantum technology using optimal control to manipulate its wave function as well as future accountable systems by a permissioned blockchain framework.

## Recent research

- Magnetic Model for Variable-Flux Interior Magnet Synchronous Motors ..... 78
- High-Torque Direct-Drive Vernier Permanent Magnet Motor ..... 78
- Long-Horizon Motion Planning for Autonomous Vehicle Parking ..... 79
- Robust Camera Pose Estimation for Image Stitching ..... 79
- Emerging GaN technologies for power, RF, digital and quantum computing ..... 80
- Optimal Control for Quantum Metrology via Pontryagin's Principle ..... 81
- Blockchain for Embedded System Accountability ..... 81

## Magnetic Model for Variable-Flux Interior Magnet Synchronous Motors

Citation: Wang, B., Shin, K.-H., Hidaka, Y., Kondo, S., Arita, H., Ito, K., "Analytical Magnetic Model for Variable-Flux Interior Permanent Magnet Synchronous Motors", IEEE Energy Conversion Congress and Exposition (ECCE), DOI: 10.1109/ECCE47101.2021.9595341, October 2021, pp. 4142-4148.

Contacts: Bingnan Wang

We present a new semi-analytical magnetic modeling method for a variable-flux interior permanent magnet synchronous motor (IPMSM), which features both permanent magnets and field windings in the rotor. Developed on a subdomain framework, we account for all the excitation sources, the finite permeability of rotor core, and the stator slotting effect in the calculation to obtain key electromagnetic performance metrics, such as back-EMF and torque. The calculation is validated with high-fidelity finite-element simulations and experimental results from a prototype motor.

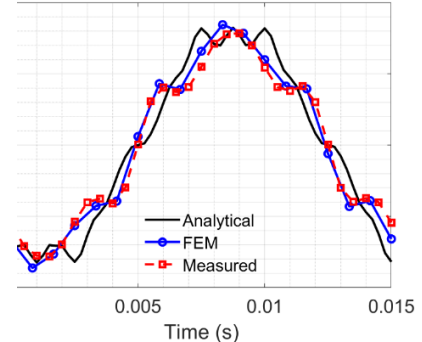

## High-Torque Direct-Drive Vernier Permanent Magnet Motor

Citation: Zhou, L., Guo, F., Wang, H., Wang, B., "High-Torque Direct-Drive Machine with Combined Axial- and Radial-flux Out-runner Vernier Permanent Magnet Motor", IEEE International Electric Machines and Drives Conference (IEMDC), DOI: 10.1109/IEMDC47953.2021.9449499, May 2021, pp. 1-8.

Contacts: Bingnan Wang

This paper presents the design, modeling, and simulation for a novel type of high-torque motor, targeting various direct-drive applications, such as robotic actuator, precision motion rotatry stages, and in-wheel drive for electrical vehicles. The key idea of the motor design is to use a combination of (a) combined axial- and radial-flux electric machine and (b) Vernier permanent magnet (VPM) motor. Such combination effectively increases the torque generation capability for the proposed motor, and makes it attractive for direct-drive applications. Analytical model for the motor's performance is derived and is validated using finite element method (FEM), and is used for optimizing the motor design parameters. Motor's losses and efficiency are evaluated by finite element simulations for various magnetic material selections. The simulation result of the proposed motor demonstrates a 1.5x torque improvement compared with a baseline off-the-shelf direct-drive machine of the same size.

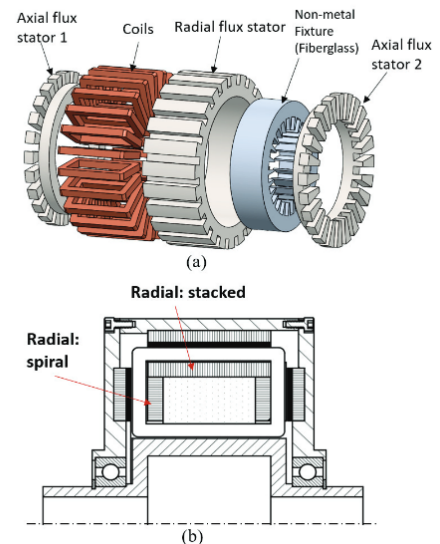

## Long-Horizon Motion Planning for Autonomous Vehicle Parking

Citation: Dai, S., Wang, Y., "Long-Horizon Motion Planning for Autonomous Vehicle Parking Incorporating Incomplete Map Information", IEEE International Conference on Robotics and Automation (ICRA), DOI: 10.1109/ICRA48506.2021.9562101, May 2021, pp. 8135-8142.

Contacts: Yebin Wang

This paper presents a hierarchical motion planning approach that can provide real-time parking plans for autonomous vehicles with limited memory. Through combining a high-level

route planner that searches for collision-free routes given traffic and obstacle information and a low-level motion planner that considers vehicle dynamics, our approach generates smooth trajectories with reasonable parking behaviors rapidly with very low memory consumption. Performance analysis on parking tasks in simulation environments demonstrates the advantages of the proposed approach in terms of both trajectory quality and planning time.

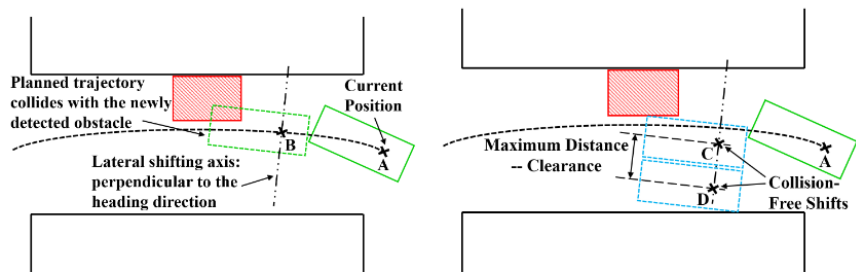

## Robust Camera Pose Estimation for Image Stitching

Citation: Shi, L., Liu, D., Thornton, J.E., "Robust Camera Pose Estimation for Image Stitching", IEEE International Conference on Image Processing (ICIP), DOI: 10.1109/ICIP42928.2021.9506680, September 2021.

Contacts: Dehong Liu, Jay Thornton

Camera poses play a crucial role in stitching overlapped images captured by the camera to achieve a broad view of interest. In this paper, we proposed a robust camera pose estimation approach to stitching images of a

large 3D surface of known geometry. In particular, given a collection of images, we first construct matrices of relative camera poses, where each entry is achieved by solving a perspective-n-point (PnP) problem over its corresponding pair of images. We then jointly estimate camera poses by solving an optimization problem that exploits the underlying rank-2 matrix of relative poses and the joint sparsity of camera pose errors. Lastly images are projected to the 3D surface of interest based on estimated camera poses for further stitching process. Numerical experiments demonstrate that our proposed method outperforms existing methods in terms of reducing camera pose errors and improving PSNRs of stitched images.

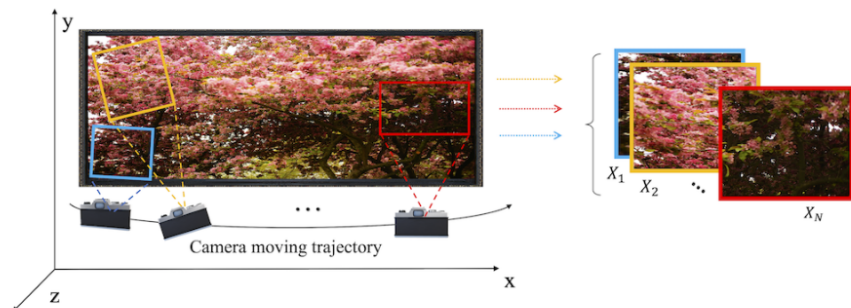

## Emerging GaN technologies for power, RF, digital and quantum computing

Citation: Teo, K.H., Zhang, Y., Chowdhury, N., Rakheja, S., Ma, R., Xie, Q., Yagyu, E., Yamanaka, K., Li, K., Palacios, T., "Emerging GaN technologies for power, RF, digital and quantum computing applications: recent advances and prospects", Journal of Applied Physics, DOI: 10.1063/5.0061555, December 2021.

Contacts: Koon Hoo Teo

GaN technology is not only gaining traction in power and RF electronics but is rapidly expanding into other application areas including digital and quantum computing electronics. This paper provides a glimpse of future GaN device technologies and advanced modeling approaches that can push the boundaries of these applications in terms of performance and reliability. While GaN power devices have recently been commercialized in the 15-900 V classes, new GaN devices are greatly desirable to explore both the higher-voltage and ultra-low-voltage power applications.

Moving into the RF domain, ultra-high frequency GaN devices are being used to implement digitized power amplifier circuits, and further advances using hardware-software co-design approach can be expected. On the horizon is the GaN CMOS technology, a key missing piece to realize the full-GaN platform with integrated digital, power and RF electronics technologies. Although currently a challenge, high-performance p-type GaN technology will be crucial to realize high-performance GaN CMOS circuits. Due to its excellent transport characteristics and ability to generate free carriers via polarization doping, GaN is expected to be an important technology for ultra-low temperature and quantum computing electronics. Finally, given the increasing cost of hardware prototyping of new devices and circuits, the use of high-fidelity device models and data-driven modeling approaches for technology-circuit co-design are projected to be the trends of the future. In this regard, physically inspired, mathematically robust, less computationally taxing, and predictive modeling approaches are indispensable. With all these and future efforts, we envision GaN to become the next Si for electronics.

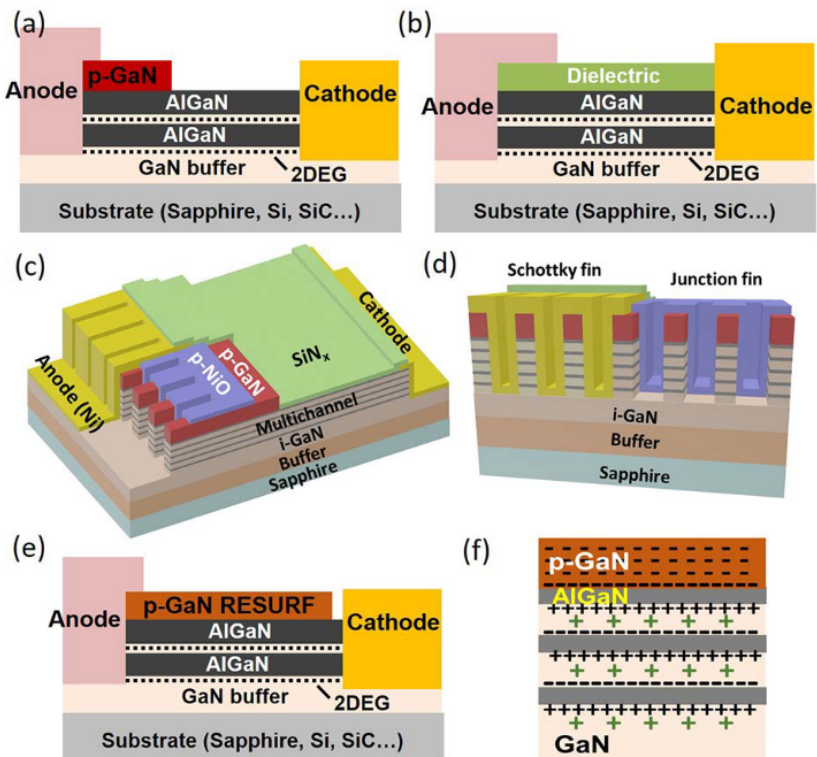

## Optimal Control for Quantum Metrology via Pontryagin's Principle

Citation: Lin, C., Ma, Y., Sels, D., "Optimal Control for Quantum Metrology via Pontryagin's principle", Physical Review, DOI: 10.1103/PhysRevA.103.052607, Vol. 103, No. 5, pp. 052607, May 2021.

Contacts: Chungwei Lin, Yanting Ma

Quantum metrology comprises a set of techniques and protocols that utilize quantum features for parameter estimation which can in principle outperform any procedure based on classical physics. We

formulate the quantum metrology in terms of an optimal control problem and apply Pontryagin's Maximum Principle to determine the optimal protocol that maximizes the quantum Fisher information for a given evolution time. As the quantum Fisher information involves a derivative with respect to the parameter which one wants to estimate, we devise an augmented dynamical system that explicitly includes gradients of the quantum Fisher information. The necessary conditions derived from Pontryagin's Maximum Principle are used to quantify the quality of the numerical solution.

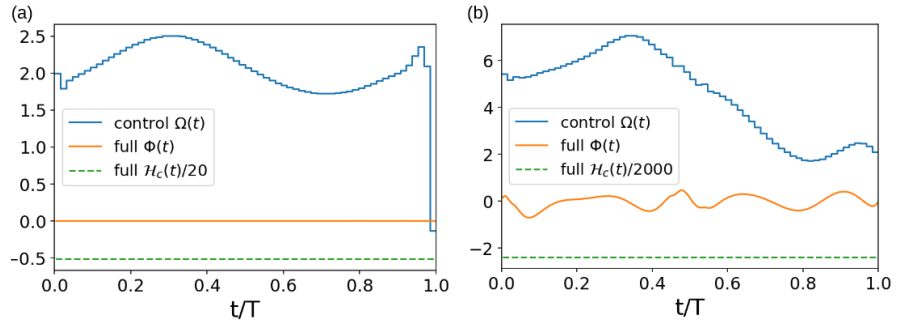

## Blockchain for Embedded System Accountability

Citation: Chiu, M., Goldsmith, A.M., Kalabic, U., "Blockchain for Embedded System Accountability", IEEE International Conference on Blockchain and Cryptocurrency (ICBC), DOI: 10.1109/ICBC51069.2021.9461143, May 2021.

Contacts: Abraham M. Goldsmith

We present, in the form of a proof of concept, a permissioned blockchain framework that attains accountability within a system containing embedded devices. Accountability is a desirable property of distributed systems that enables the detection, identification, and removal of faulty or malicious behavior. It is a complementary approach to Byzantine fault tolerance, which is concerned with ensuring continued functioning of the system in the presence of Byzantine faults. Our proof of concept consists of a Raspberry Pi acting as a human interface; the blockchain is implemented in Hyperledger Fabric and the Raspberry Pi runs a lightweight blockchain client to minimize computational burden. The application shows that we are able to use smart contracts to detect and identify faulty or malicious hardware, and the permissioning framework to remove it.

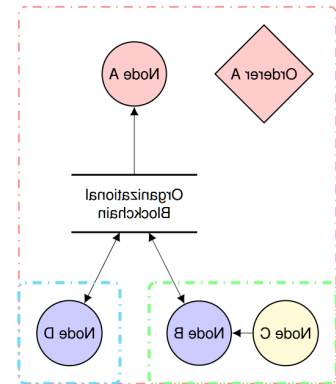



# Multi-Physical Systems

This area covers research on modeling, simulation, and model-based design of dynamic systems, advanced machines, and devices. This research serves as a foundation for and is integrated with other technologies, such as signal processing, control, optimization, and artificial intelligence. We investigate modeling fundamentals including mathematical formulations of multi-physical dynamics, accurate models of complex systems via state-of-the-art modeling tools, fundamental principles and applied physics research, rapid simulations via model reduction and parallel solvers, and model-based design process for optimization of architecture, control and performance.

Much of this research focuses on system analysis in the following areas: the development and application of new tools to model and simulate complex, heterogeneous systems; the creation of new multi-physical system designs (architectures) and performance metrics; the invention of new optimal control, coordinating control, and estimation algorithms; and the use of collaborative design tools and processes for future products. Target applications include model-based design, control, and optimization of HVAC systems; motion control; energy systems; advanced assembly lines in factories; and digital twin systems for zero-energy buildings and factory automation.

## Recent research

- Patch-based Thermodynamic Property Models for the Subcritical Region ..... 84
- Modeling Contact and Collisions for Robotic Assembly Control ..... 84
- Modeling & Analysis of Pressure Drop Oscillations in Horizontal Boiling Flow ..... 85
- A fast fluid dynamics model for simulating indoor airflow ..... 85
- H-Infinity Loop-Shaped Model Predictive Control with HVAC Application ..... 86
- Modelica-Based Control of a Delta Robot..... 86
- Safe Learning-based Observers for Unknown Nonlinear Systems..... 87
- Accelerating self-optimization control of refrigerant cycles ..... 87
- Scalable Bayesian Optimization for Model Calibration: ..... 88
- Optimization for Scalable Calibration of Physics-Informed Digital Twins ..... 88

## Patch-based Thermodynamic Property Models for the Subcritical Region

Citation: Laughman, C.R., Qiao, H., "Patch-based Thermodynamic Property Models for the Subcritical Region", Purdue Air-Conditioning and Refrigeration Conference, May 2021.

Contacts: Christopher R. Laughman, Hongtao Qiao

Model-based design approaches for vapor-compression cycles depend heavily upon refrigerant property representations that are fast, accurate, and consistent. We describe an approach based upon B-spline interpolants that describes properties such as density, temperature, and specific entropy as the intersection of multiple surfaces, which are referred to as “patches.” When combined with a transformation of thermodynamic coordinates, this approach can calculate the density over a domain with a maximum absolute percentage error less than  $3 \times 10^{-5}$  and a speedup over REFPROP of greater than 100x.

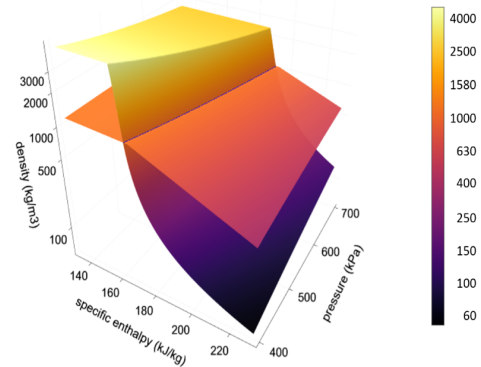

## Modeling Contact and Collisions for Robotic Assembly Control

Citation: Bortoff, S.A., "Modeling Contact and Collisions for Robotic Assembly Control", American Modelica Conference 2020, March 2020.

Contacts: Scott Bortoff

We propose an implicit, event-driven, penalty-based method for modeling rigid body contact and collision that is useful for design and analysis of control algorithms for precision robotic assembly tasks. The method is based on Baumgarte’s method of

differential algebraic equation index reduction in which we modify the conventional constraint stabilization to model object collision, define a finite state machine to model transition between contact and non-contact states, and represent the robot and task object dynamics as a single set of differential algebraic inequalities. The method, which is realized natively in Modelica, has some advantages over conventional penalty-based methods: The resulting system is not numerically stiff after the collision transient, it enforces constraints for object penetration, and it allows for dynamic analysis of the Modelica model beyond time-domain simulation. We provide three examples: A bouncing ball, a ball maze, and a delta robot controlled to achieve soft collision and maintain soft contact with an object in its environment.

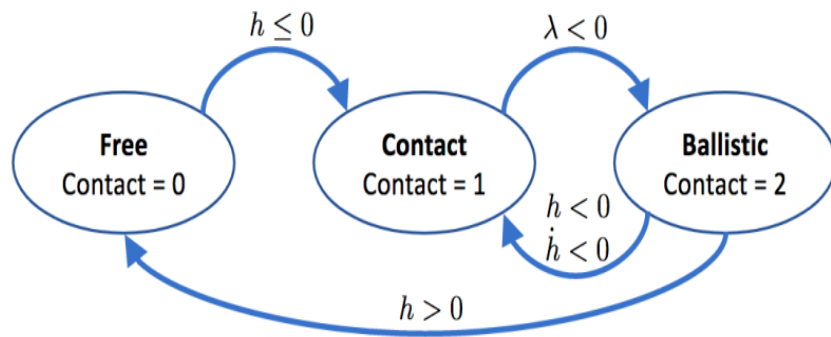



## Modeling & Analysis of Pressure Drop Oscillations in Horizontal Boiling Flow

Citation: Qiao, H., Laughman, C.R., "Modeling and Analysis of Pressure Drop Oscillations in Horizontal Boiling Flow", International Refrigeration and Air Conditioning Conference at Purdue, August 2021.

Contacts: Hontao Qiao, Christopher R. Laughman

In general, two-phase flow phenomena can be described based on the one-dimensional conservation laws. Models with different formulations can be obtained with different assumptions. This paper presents three models with different complexity to simulate pressure drop oscillations. The direct comparison indicates that there are substantial differences between these models. The mechanism of pressure drop oscillations is discussed and the effect of operating parameters on system instability is explored. It is shown that two bifurcation points can exist when varying heat input and inlet subcooling. Root locus analysis corroborates the simulation results.

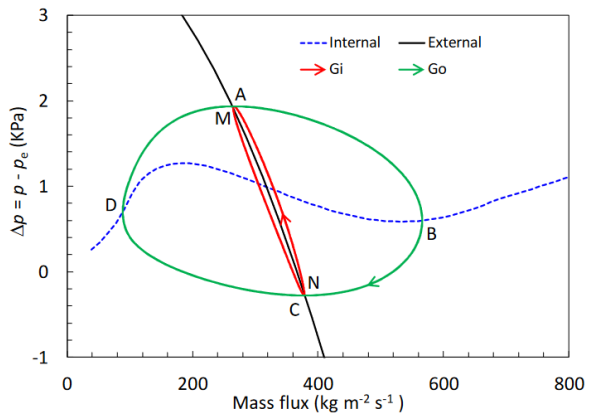

## A fast fluid dynamics model for simulating indoor airflow

Citation: Li, S., Qiao, H., "Development of a fast fluid dynamics model based on PISO algorithm for simulating indoor airflow", ASME - Summer Heat Transfer Conference, DOI: HT2021-63909, September 2021.

Contacts: Hongtao Qiao

Real-time or faster-than-real-time flow simulation is crucial for studying airflow and heat transfer in buildings, such as building design, building emergency management and building energy performance evaluation. Computational Fluid Dynamics (CFD) with PISO or SIMPLE algorithm is accurate but requires great computational resources. Fast Fluid Dynamics (FFD) can reduce the computational effort but generally lack prediction accuracy due to simplification. This study developed a fast computational method based on FFD in combination with the PISO algorithm. Boussinesq approximation is adopted for simulating buoyancy effect. The proposed solver is tested in a two-dimensional case and a three-dimensional case with experimental data. The predicted results have good agreement with the experimental results and at the same time, the proposed method can reduce computational cost greatly compared to CFD.

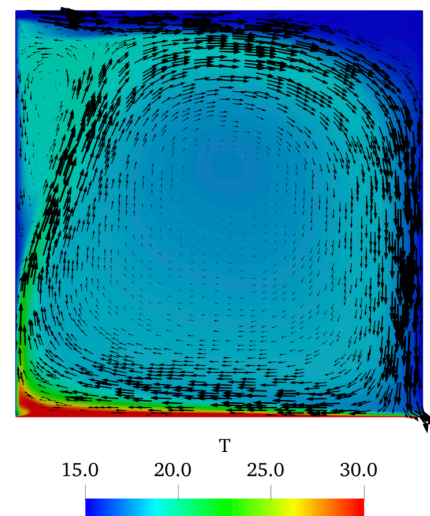

## H-Infinity Loop-Shaped Model Predictive Control with HVAC Application

Citation: Bortoff, S.A., Schwerdtner, P., Danielson, C., Di Cairano, S., Burns, D.J., "H-Infinity Loop-Shaped Model Predictive Control with HVAC Application", IEEE Transactions on Control Systems Technology, DOI: 10.1109/TCST.2022.3141937, Vol. 30, No. 5, pp. 2188-2203, March 2022.

Contacts: Scott A. Bortoff, Stefano Di Cairano

We formulate a Model Predictive Control (MPC) for linear time-invariant systems based on H-infinity loop-shaping. The design results in a closed-loop system that includes a state estimator and attains an optimized stability margin. Input and output weights are designed in the frequency domain to satisfy steady-state and transient performance requirements, in lieu of standard MPC plant model augmentations. The H-infinity loop-shaping synthesis results in an observer-based state feedback structure. An inverse optimal control problem is solved to construct the MPC cost function, so that the control input computed by MPC is equal to the H-infinity control input when the constraints are inactive. The MPC inherits the closed-loop performance and stability margin of the loop-shaped design when constraints are inactive.

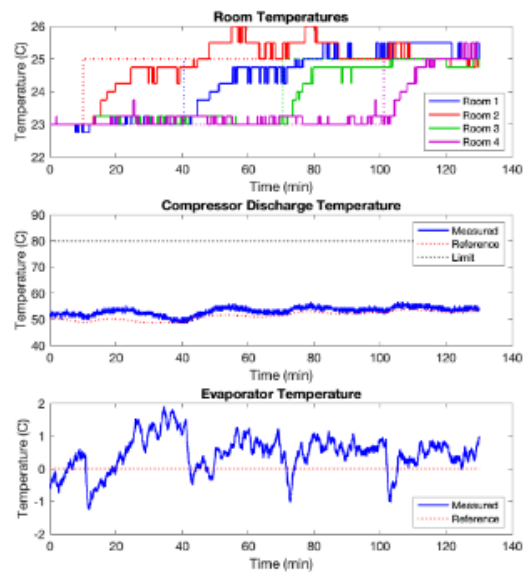

## Modelica-Based Control of a Delta Robot

Citation: Bortoff, S.A., Okasha, A., "Modelica-Based Control of A Delta Robot", ASME Dynamic Systems and Control Conference, DOI: doi.org/10.1115/DSCC2020-3158, December 2020.

Contacts: Scott A. Bortoff

We derive a dynamic model of the delta robot and two formulations of the manipulator Jacobian that comprise a system of singularity-free, index-one differential algebraic equations that is well-suited for model-based control design and computer simulation. One of the Jacobians is intended for time-domain simulation, while the other is for use in discrete-time control algorithms. The model is well posed and numerically well-conditioned throughout the workspace, including at kinematic singularities. We use the model to derive an approximate feedback linearizing control algorithm that can be used for both trajectory tracking and impedance control.

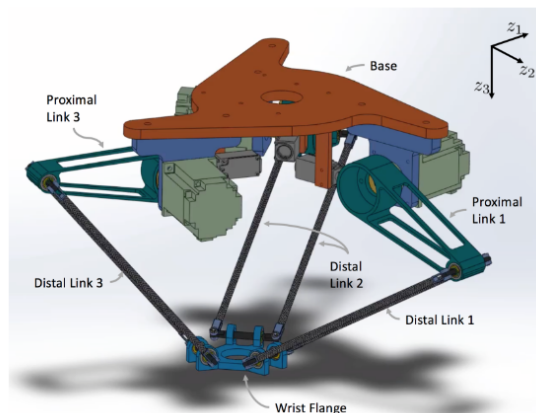

## Safe Learning-based Observers for Unknown Nonlinear Systems

Citation: Chakrabarty, A., Benosman, M., "Safe Learning-based Observers for Unknown Nonlinear Systems using Bayesian Optimization", *Automatica*, DOI: 10.1016/j.automatica.2021.109860, August 2021.

Contacts: Ankush Chakrabarty, Mouhacine Benosman

Data generated from dynamical systems with unknown dynamics enable the learning of state observers that are: robust to modeling error, computationally tractable to design, and capable of operating with guaranteed performance. In this paper, a modular design methodology is formulated, that consists of three design phases: (i) an initial robust observer design that enables one to learn the dynamics without allowing the state estimation error to diverge (hence, safe); (ii) a learning phase wherein the unmodeled components are estimated using Bayesian optimization and Gaussian processes; and, (iii) a re-design phase that leverages the learned dynamics to improve convergence rate of the state estimation error.

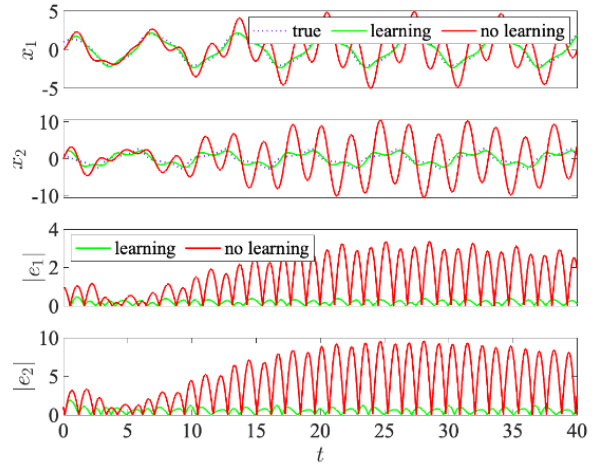

## Accelerating self-optimization control of refrigerant cycles

Citation: Chakrabarty, A., Danielson, C., Bortoff, S.A., Laughman, C.R., "Accelerating self-optimization control of refrigerant cycles with Bayesian optimization and adaptive moment estimation", *Applied Thermal Engineering*, DOI: 10.1016/j.applthermaleng.2021.117335, Vol. 197, pp. 117335, February 2022.

Contacts: Ankush Chakrabarty, Scott A. Bortoff, Christopher R. Laughman

This paper presents a model-free self-optimization control algorithm for modulating multiple inputs simultaneously to minimize the power consumption of a Vapor Compression System (VCS). We propose the use of Bayesian Optimization (BO) to warm-start a state-of-the-art Extremum Seeking Control (ESC) algorithm and then accelerate the ESC on-line with Adam, a well-studied algorithm used to train deep neural networks. BO initializes the ESC at conditions

favorable for rapid convergence while concurrently learning a surrogate map of VCS power consumption as a function of the inputs. In addition, the warm-start increases the likelihood of attaining a global optimum for locally convex, but globally non-convex, objective functions by identifying regions where the global optimum most likely resides. The proposed algorithm is evaluated using a Modelica model of an air conditioning system.

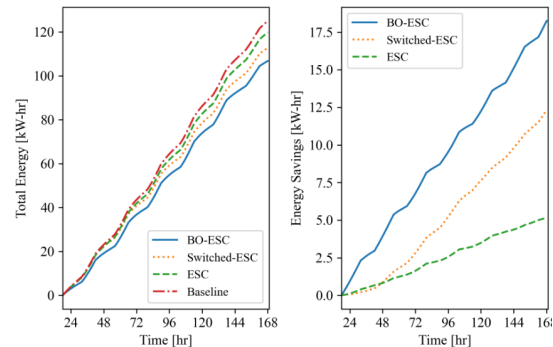

## Scalable Bayesian Optimization for Model Calibration:

Citation: Chakrabarty, A., Maddalena, E., Qiao, H., Laughman, C.R., "Scalable Bayesian Optimization for Parameter Estimation of Coupled Building and HVAC Dynamics", Energy and Buildings, DOI: 10.1016/j.enbuild.2021.111460, Vol. 253, pp. 111460, March 2022.

Contacts: Ankush Chakrabarty, Hongtao Qiao, Christopher R. Laughman

Model calibration for building systems is a key step to achieving accurate and reliable predictions that reflect the dynamics of real systems under study. Calibration becomes particularly challenging when integrating building and HVAC dynamics, due to large-scale, nonlinear, and stiff underlying differential algebraic equations. We describe a framework for calibrating multiple parameters of coupled building/HVAC models using scalable Bayesian optimization (BO), whose advantages include global optimization without requiring gradient information. The proposed methodology is improved online via two additional steps: domain tightening and domain slicing, both of which leverage the surrogate calibration cost function.

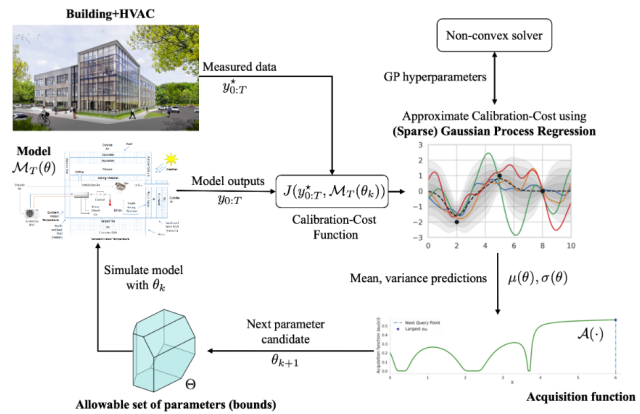

## Optimization for Scalable Calibration of Physics-Informed Digital Twins

Citation: Chakrabarty, A., Wichern, G., Laughman, C.R., "ANP-BBO: Attentive Neural Processes and Batch Bayesian Optimization for Scalable Calibration of Physics-Informed Digital Twins", International Conference on Machine Learning (ICML), July 2021.

Contacts: Ankush Chakrabarty, Gordon Wichern, Christopher R. Laughman

Physics-informed dynamical system models form critical components of digital twins of the built environment. These digital twins enable the design of energy-efficient infrastructure, but must be properly calibrated to accurately reflect system behavior for downstream prediction and analysis. Dynamical system models of modern buildings

are typically described by a large number of parameters and incur significant computational expenditure during simulations. To handle largescale calibration of digital twins without exorbitant simulations, we propose ANP-BBO: a scalable and parallelizable batch-wise Bayesian optimization (BBO) methodology that leverages attentive neural processes (ANPs).

